



MBC
Cutting Tools



2024
O C A K

Euro Fiyat Listesi
Euro Price List





“Siz üretirken biz destek oluyoruz”
“We support while you produce”





Misyonumuz

Sürdürülebilir kalkınmayı kendimize yol haritası kabul ederek; çevreye duyarlı, en az maliyetle, paydaşlarımızın isteklerini karşılayan bir şirket olmaktır.

Our Mission

To be a company which recognise sustainable development as a road map to us to meet the demands of our clients with environmentally sensitive with minimal cost.

Vizyonumuz

Toplam kalite felsefesi ile Dünya Sanayisi'ne güvenilir, kaliteli ürün ve hizmet vermektir.

Müşteri istek ve ihtiyaçlarını tam olarak anlamak ve karşılamak, kalite yönetim sistemimizin gelişimini ve etkinliğini sağlayarak iç ve dış pazarda rekabet gücümüzü arttırmak, sürekli gelişmek için tüm çalışanların eğitimini ve katılımını sağlamak, ürün kalitemizi arttırmak ve maliyetlerimizi düşürmek.

Sektörümüzdeki teknolojik gelişmeleri yakından takip etmek ve bu gelişmeleri her alanda uygulamak.











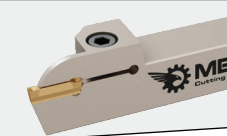
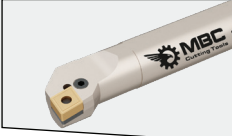
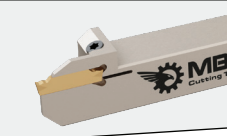
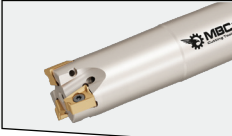
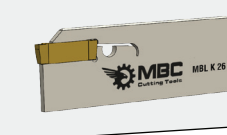
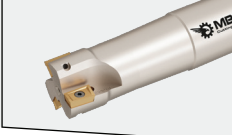

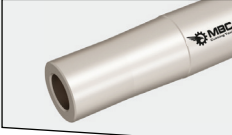

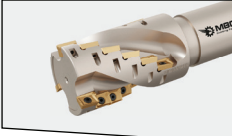

Vision

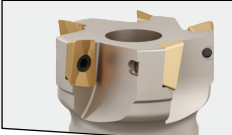
With the philosophy of total quality; serve the World Industrial Estate reliable and high quality products.

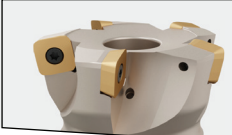
Understand exactly what the clients requests and needs; provide the development and effectiveness of our quality management system to increase our competitiveness in domestic and international market; to continuous development ensure the training and participation of all employees; improve the products quality and reduce the costs.

Follow the technological developments in our industry and implement these developments in all areas.

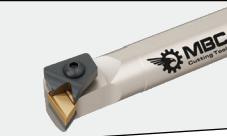
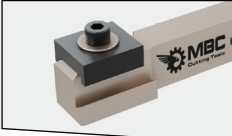
İÇİNDEKİLER INDEX

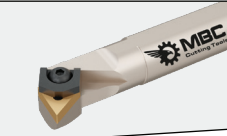
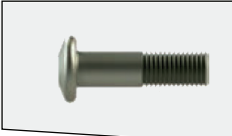
sayfa/page 12-16		DIŞ KANAL KATERLERİ EXTERNAL GROOVING TOOLHOLDERS	P-SİSTEM İÇ ÇAP TORNALAMA KATERLERİ P-SYSTEM INTERNAL TURNING TOOLHOLDERS		sayfa/page 48-49
sayfa/page 17		DIŞ KANAL KATERLERİ OTOMAT EXTERNAL GROOVING TOOLHOLDERS AUTOMAT	ŞAFTLI TARAMALAR MILLING TOOLS		sayfa/page 51-77
sayfa/page 18-19		KESME TAKIMLARI BLADE TOOLS	ŞAFTLI TARAMALAR HIGH FEED MILLING TOOLS HIGH FEED		sayfa/page 78-86
sayfa/page 21-23		İÇ KANAL KATERLERİ INTERNAL GROOVING TOOLHOLDERS	VİDALI TAKIM TUTUCULARI SCREW TOOL HOLDERS		sayfa/page 87
sayfa/page 25-29		S-SİSTEM DIŞ ÇAP TORNALAMA KATERLERİ S-SYSTEM EXTERNAL TURNING TOOLHOLDERS	HIGH FEED FINISH TAKIMLARI HIGH FEED FINISH TOOLS		sayfa/page 89
sayfa/page 31-32		C-SİSTEM DIŞ ÇAP TORNALAMA KATERLERİ C-SYSTEM EXTERNAL TURNING TOOLHOLDERS	FREZELEME TAKIMLARI FACE MILLING		sayfa/page 91-93
sayfa/page 33-35		T-SİSTEM DIŞ ÇAP TORNALAMA KATERLERİ T-SYSTEM EXTERNAL TURNING TOOLHOLDERS	TARAMA KAFALARI FACE MILLING		sayfa/page 95-127
sayfa/page 36		M-SİSTEM DIŞ ÇAP TORNALAMA KATERLERİ M-SYSTEM EXTERNAL TURNING TOOLHOLDERS	HIGH FEED TARAMA KAFALARI HIGH FEED MILLINGS		sayfa/page 128-138
sayfa/page 37-38		P-SİSTEM DIŞ ÇAP TORNALAMA KATERLERİ P-SYSTEM EXTERNAL TURNING TOOLHOLDERS	VİDALI TARAMALAR SCREW TYPE		sayfa/page 140-153
sayfa/page 40-43		S-SİSTEM İÇ ÇAP TORNALAMA KATERLERİ S-SYSTEM INTERNAL TURNING TOOLHOLDERS	U-DRILLER U-DRILLS		sayfa/page 155-162
sayfa/page 45		C-SİSTEM İÇ ÇAP TORNALAMA KATERLERİ C-SYSTEM INTERNAL TURNING TOOLHOLDERS	KATERLER CUTTING TOOLS		sayfa/page 163-164
sayfa/page 45-47		T-SİSTEM İÇ ÇAP TORNALAMA KATERLERİ T-SYSTEM INTERNAL TURNING TOOLHOLDERS	YUMUŞAK AYAKLAR SOFT JAWS		sayfa/page 165
sayfa/page 47-48		M-SİSTEM İÇ ÇAP TORNALAMA KATERLERİ M-SYSTEM INTERNAL TURNING TOOLHOLDERS	YEDEK PARÇALAR SPARE PARTS		sayfa/page 166-168

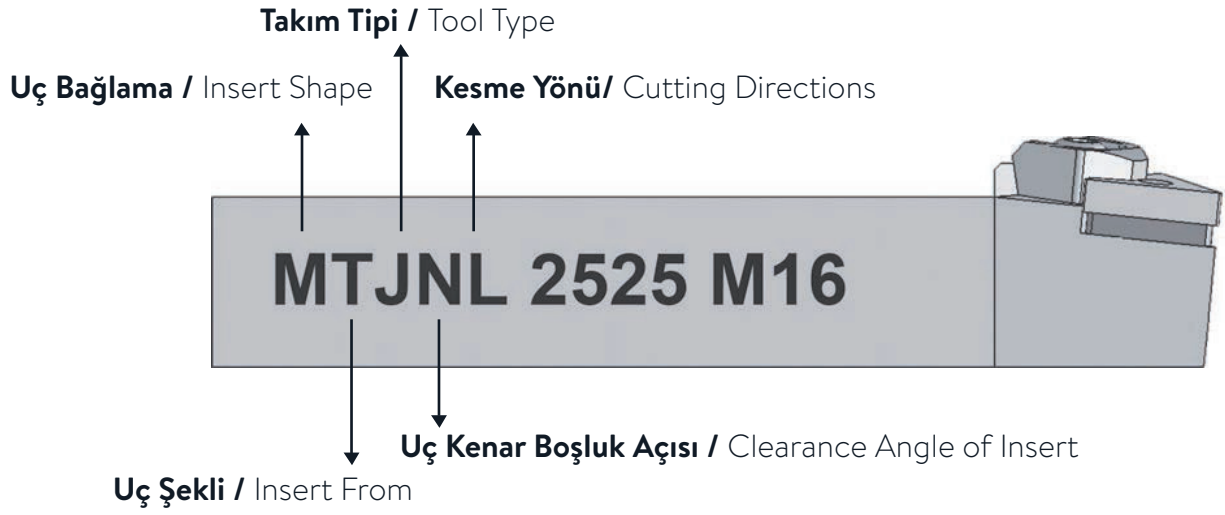

Takım Tipi / Tool Type ————— **Kesme Yönü / Cutting Directions**

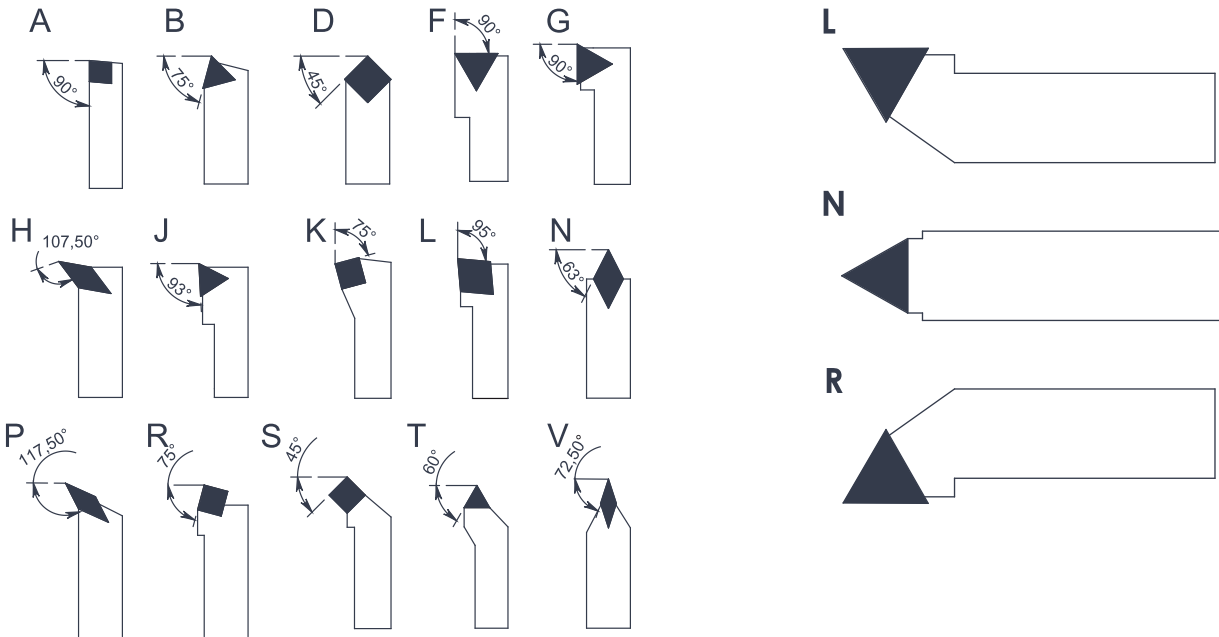

Uç Şekli / Insert From ————— **Uç Kenar Boşluk Açısı / Clearance Angle of Insert**

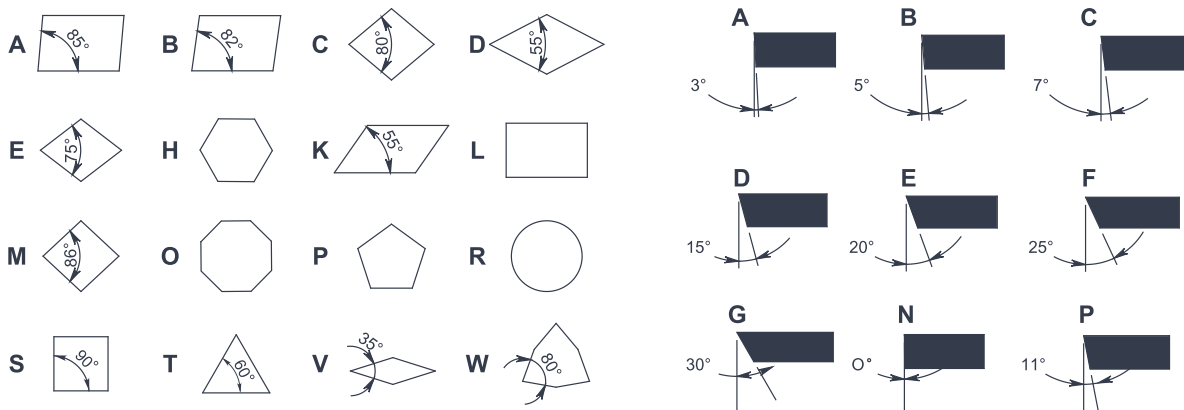

M Sistem
M System

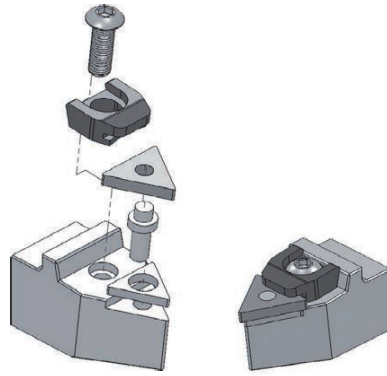

S Sistem
S System

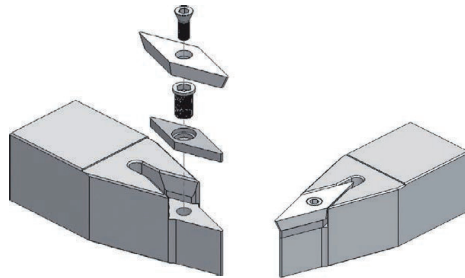

T Sistem
T System

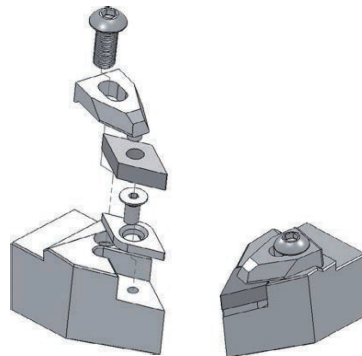



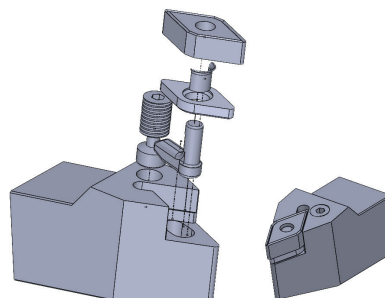





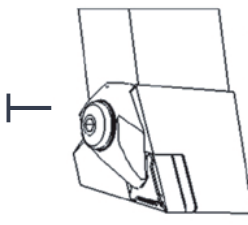
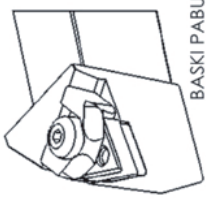
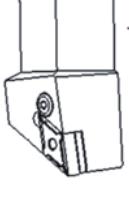















































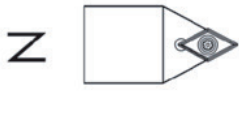





































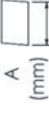
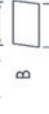
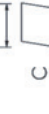

P Sistem
P System



DIŞ ÇAP KATERLERİ İÇİN ISO KODLARI

EXTERNAL TURNING TOOLS ISO CODES

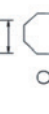
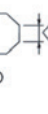
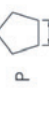
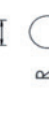
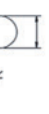
1	2	3	4	5	6	7	8	9
T	D	J	N	R	20	20	K	15
1	2	3	4	5	6	7	8	9
Uç Bağlama Sistemi Clamping System Klemmsystem	Kesici Uç Tipi Insert form WSP - Form	Kater Tipi Style Werkzeugtyp	Uç Açısı Clearance angle WSP-Freiwinkel	Kater Yönü Holder execution Bearbeitungs-richtung	Şaft Yüksekliği Height of shank Schaftquerschnitts	Şaft Genişliği Width of shank Schaftbreite	Takım Boyu Length of holder Werkzeuglänge	Uç Kenar Uzunluğu Length of cutting ed WSP-Größe
 T  M ÇEKİRMELİ  P BASKI PABUÇLU  S LEVYELİ  VİDALI	 A 85°  B 85°  C 80°  D 55°  E 75°  H 130°  K 55°  L 90°  M 80°  O 125°  P 100°  R  S 90°  T 60°  V 35°  W 80°	 A  B  C  D  E  F  G  J  K  L  N  P  Q  R  S  V	 A 3°  B 5°  C 7°  D  E 15°  F 20°  G 25°  P 30°  N 11°  ÖZEL SPECIAL  Sonderform	 L  R  N	 06=6  08=8  10=10  12=12  14=14  16=16  20=20  22=22  25=25  32=32  40=40  50=50	 06=6  08=8  10=10  12=12  14=14  16=16  20=20  22=22  25=25  32=32  40=40  50=50	 D=60  E=70  F=80  G=90  H=100  J=110  K=125  L=140  M=150  N=160  P=170  Q=180  R=200  S=250  T=300 U=350 V=400 W=450 Y=500 X=ÖZEL Special Sonderform	 A (mm)  B  C  D  E  K  L  M  O  P  R  S  T  V  W

TORNALAMA UÇLARI İÇİN ISO KODLARI

TURNING INSERT ISO CODES

1 Kesici Uç Tipi
Shape
Plattentyp

2 Uç Açısı
Clearance Angle
Fräswinkel

4 Kesici Delik Tipi
Type of Insert
Plattentyp

6 Uç Kalınlığı
Height of Cutting Edge
Schneidkantenhöhe

7 Uç Radüsü
Chamfer or Corner Radius
Planfase Oder Eckenradius

1 **D** → 2 **N** → 3 **M** → 4 **G** → 5 **15** → 6 **06** → 7 **08** → 8 **H** → 9 **R**

SEMBOL Shape Plattentyp	Uç Toleransları Tolerance Toleranz		d (±)
	m (±)	s (±)	
A	0,005	0,025	0,025
F	0,005	0,025	0,013
C	0,013	0,025	0,025
H	0,013	0,025	0,013
E	0,025	0,025	0,025
G	0,025	0,130	0,025
J	0,005	0,025	0,05-0,013
K	0,013	0,025	0,05-0,013
L	0,025	0,025	0,05-0,013
M	0,08-0,18	0,130	0,05-0,013
N	0,08-0,18	0,025	0,05-0,013
U	0,05-0,38	0,130	0,08-0,025

5 Kesme Kenar Uzunluğu
Length of Cutting Edge
Schneidenlänge

Kesme Kenarı Şekli
Insert Forms
WSP-Form

Uç Formları
Insert Forms
WSP-Form



DIŐ KANAL KATERLERİ

EXTERNAL GROOVING TOOLHOLDERS

DKT I



DKT K



DKT H



KOD	Stok / Stock		Kesici Uç Uyumluluđu / Insert Suitability	FİYAT PRICE
	R	L		DKT I
DKT I 001 DGN	✓	✓	DKT I 12X12 2C (Tmax=14)	71,00 €
DKT I 021 DGN	✓	✓	DKT I 16X16 2C (Tmax=18)	71,00 €
DKT I 003 DGN	✓	✓	DKT I 20X20 2C (Tmax=18)	74,33 €
DKT I 004 DGN	✓	✓	DKT I 25X25 2C (Tmax=22)	77,33 €
DKT I 005 DGN	✓	✓	DKT I 12X12 3C (Tmax=14)	71,00 €
DKT I 006 DGN	✓	✓	DKT I 16X16 3C (Tmax=18)	71,00 €
DKT I 007 DGN	✓	✓	DKT I 20X20 3C (Tmax=18)	74,33 €
DKT I 008 DGN	✓	✓	DKT I 25X25 3C (Tmax=22)	77,33 €
DKT I 009 DGN	✓	✗	DKT I 32X32 3C (Tmax=22)	89,67 €
DKT I 010 DGN	✓	✓	DKT I 16X16 4C (Tmax=18)	71,00 €
DKT I 011 DGN	✓	✓	DKT I 20X20 4C (Tmax=18)	74,33 €
DKT I 012 DGN	✓	✓	DKT I 25X25 4C (Tmax=22)	77,33 €
DKT I 013 DGN	✓	✗	DKT I 32X32 4C (Tmax=22)	89,67 €
DKT I 014 DGN	✓	✓	DKT I 20X20 5C (Tmax=22)	74,33 €
DKT I 015 DGN	✓	✓	DKT I 25X25 5C (Tmax=22)	77,33 €
DKT I 016 DGN	✓	✗	DKT I 32X32 5C (Tmax=22)	89,67 €
DKT I 017 DGN	✓	✓	DKT I 25X25 6C (Tmax=22)	77,33 €
DKT I 018 DGN	✓	✗	DKT I 32X32 6C (Tmax=22)	89,67 €
DKT I 019 DGN	✓	✓	DKT I 25X25 3C (Tmax=40)	126,67 €
DKT I 020 DGN	✓	✓	DKT I 25X25 4C (Tmax=40)	126,67 €

KOD	Stok / Stock		Kesici Uç Uyumluluđu / Insert Suitability	FİYAT PRICE
	R	L		KRLY MGM.
DKT K 001 MGM.	✓	✓	DKT K 12X12 2C (Tmax=14)	68,00 €
DKT K 002 MGM.	✓	✓	DKT K 16X16 2C (Tmax=17)	71,00 €
DKT K 003 MGM.	✓	✓	DKT K 20X20 2C (Tmax=17)	74,33 €
DKT K 004 MGM.	✓	✓	DKT K 25X25 2C (Tmax=18)	77,33 €
DKT K 005 MGM.	✓	✗	DKT K 32X32 2C (Tmax=21)	89,67 €
DKT K 006 MGM.	✓	✓	DKT K 12X12 3C (Tmax=14)	68,00 €
DKT K 007 MGM.	✓	✓	DKT K 16X16 3C (Tmax=18)	71,00 €
DKT K 008 MGM.	✓	✓	DKT K 20X20 3C (Tmax=18)	74,33 €
DKT K 009 MGM.	✓	✓	DKT K 25X25 3C (Tmax=21)	77,33 €
DKT K 010 MGM.	✓	✗	DKT K 32X32 3C (Tmax=25)	89,67 €
DKT K 011 MGM.	✓	✓	DKT K 16X16 4C (Tmax=18)	71,00 €
DKT K 012 MGM.	✓	✓	DKT K 20X20 4C (Tmax=18)	74,33 €
DKT K 013 MGM.	✓	✓	DKT K 25X25 4C (Tmax=22)	77,33 €
DKT K 014 MGM.	✓	✗	DKT K 32X32 4C (Tmax=25)	89,67 €
DKT K 015 MGM.	✓	✓	DKT K 20X20 5C (Tmax=21)	71,00 €
DKT K 016 MGM.	✓	✓	DKT K 25X25 5C (Tmax=22)	77,33 €
DKT K 017 MGM.	✓	✗	DKT K 32X32 5C (Tmax=25)	89,67 €
DKT K 018 MGM.	✓	✓	DKT K 25X25 6C (Tmax=22)	77,33 €
DKT K 019 MGM.	✓	✗	DKT K 32X32 6C (Tmax=25)	89,67 €
DKT K 020 MGM.	✓	✓	DKT K 16X16 1,5C (Tmax=17)	71,00 €
DKT K 022 MGM.	✓	✓	DKT K 20X20 1,5C (Tmax=17)	74,33 €
DKT K 023 MGM.	✓	✓	DKT K 25X25 4C (Tmax=40)	126,67 €
DKT K 028 MGM.	✓	✓	DKT K 25X25 3C (Tmax=30)	119,33 €
DKT K 029 MGM.	✓	✓	DKT K 25X25 4C (Tmax=30)	119,33 €
DKT K 030 MGM.	✓	✓	DKT K 25X25 3C (Tmax=40)	126,67 €
DKT K 031 MGM.	✓	✓	DKT K 25X25 5C (Tmax=40)	126,67 €

KOD	Stok / Stock		Kesici Uç Uyumluluđu / Insert Suitability	FİYAT PRICE
	R	L		HRN S229
DKT H 001 S229	✓	✓	DKT H 16X16 3C (Tmax=22)	71,00 €
DKT H 002 S229	✓	✓	DKT H 20X20 3C (Tmax=22)	74,33 €
DKT H 003 S229	✓	✓	DKT H 25X25 3C (Tmax=23)	77,33 €
DKT H 004 S229	✓	✗	DKT H 32X32 3C (Tmax=24)	89,67 €
DKT H 005 S229	✓	✓	DKT H 20X20 4C (Tmax=22)	74,33 €
DKT H 006 S229	✓	✓	DKT H 25X25 4C (Tmax=23)	77,33 €
DKT H 007 S229	✓	✗	DKT H 32X32 4C (Tmax=24)	89,67 €
DKT H 008 S229	✓	✓	DKT H 20X20 5C (Tmax=22)	74,33 €
DKT H 009 S229	✓	✓	DKT H 25X25 5C (Tmax=23)	77,33 €
DKT H 010 S229	✓	✗	DKT H 32X32 5C (Tmax=24)	89,67 €
DKT H 011 S229	✓	✓	DKT H 25X25 6C (Tmax=23)	77,33 €

DKT HK



DKT TT



DKT ZCC2



KOD	Stok / Stock		Kesici Uç Uyumluluđu / Insert Suitability	FIYAT PRICE
	R	L	HRN S224	EURO
DKT HK 001 S224	✓	✓	DKT HK 16X16 2C (Tmax=20)	71,00 €
DKT HK 002 S224	✓	✓	DKT HK 20X20 2C (Tmax=20)	74,33 €
DKT HK 003 S224	✓	✓	DKT HK 25X25 2C (Tmax=22)	77,33 €
DKT HK 004 S224	✓	✓	DKT HK 16X16 3C (Tmax=20)	71,00 €
DKT HK 005 S224	✓	✓	DKT HK 20X20 3C (Tmax=20)	74,33 €
DKT HK 006 S224	✓	✓	DKT HK 25X25 3C (Tmax=22)	77,33 €
DKT HK 007 S224	✓	✗	DKT HK 32X32 3C (Tmax=22)	89,67 €
DKT HK 008 S224	✓	✓	DKT HK 16X16 4C (Tmax=20)	71,00 €
DKT HK 009 S224	✓	✓	DKT HK 20X20 4C (Tmax=20)	74,33 €
DKT HK 010 S224	✓	✓	DKT HK 25X25 4C (Tmax=22)	77,33 €
DKT HK 011 S224	✓	✗	DKT HK 32X32 4C (Tmax=22)	89,67 €

KOD	Stok / Stock		Kesici Uç Uyumluluđu / Insert Suitability	FIYAT PRICE
	R	L	TGTC TD..	EURO
DKT TT 001 TD..	✓	✗	DKT TT 12X12 2C (Tmax=14)	71,00 €
DKT TT 002 TD..	✓	✓	DKT TT 16X16 2C (Tmax=18)	71,00 €
DKT TT 003 TD..	✓	✓	DKT TT 20X20 2C (Tmax=18)	74,33 €
DKT TT 004 TD..	✓	✓	DKT TT 25X25 2C (Tmax=21)	77,33 €
DKT TT 005 TD..	✓	✗	DKT TT 12X12 3C (Tmax=14)	71,00 €
DKT TT 006 TD..	✓	✓	DKT TT 16X16 3C (Tmax=18)	71,00 €
DKT TT 007 TD..	✓	✓	DKT TT 20X20 3C (Tmax=18)	74,33 €
DKT TT 008 TD..	✓	✓	DKT TT 25X25 3C (Tmax=21)	77,33 €
DKT TT 009 TD..	✓	✗	DKT TT 32X32 3C (Tmax=23)	89,67 €
DKT TT 010 TD..	✓	✓	DKT TT 16X16 4C (Tmax=18)	71,00 €
DKT TT 011 TD..	✓	✓	DKT TT 20X20 4C (Tmax=18)	74,33 €
DKT TT 012 TD..	✓	✓	DKT TT 25X25 4C (Tmax=21)	77,33 €
DKT TT 013 TD..	✓	✗	DKT TT 32X32 4C (Tmax=23)	89,67 €
DKT TT 014 TD..	✓	✓	DKT TT 25X25 5C (Tmax=21)	77,33 €

KOD	Stok / Stock		Kesici Uç Uyumluluđu / Insert Suitability	FIYAT PRICE
	R	L	ZCC ZT.D	EURO
DKT ZCC2 001 ZT.D	✓	✓	DKT ZCC2 20X20 2C (Tmax=17)	74,33 €
DKT ZCC2 002 ZT.D	✓	✓	DKT ZCC2 25X25 2C (Tmax=21)	77,33 €
DKT ZCC2 004 ZT.D	✓	✓	DKT ZCC2 20X20 2,5C (Tmax=17)	74,33 €
DKT ZCC2 005 ZT.D	✓	✓	DKT ZCC2 25X25 2,5C (Tmax=21)	77,33 €
DKT ZCC2 006 ZT.D	✓	✓	DKT ZCC2 16X16 3C (Tmax=18)	71,00 €
DKT ZCC2 007 ZT.D	✓	✓	DKT ZCC2 20X20 3C (Tmax=18)	74,33 €
DKT ZCC2 008 ZT.D	✓	✓	DKT ZCC2 25X25 3C (Tmax=21)	77,33 €
DKT ZCC2 009 ZT.D	✓	✓	DKT ZCC2 16X16 4C (Tmax=18)	71,00 €
DKT ZCC2 010 ZT.D	✓	✓	DKT ZCC2 20X20 4C (Tmax=18)	74,33 €
DKT ZCC2 011 ZT.D	✓	✓	DKT ZCC2 25X25 4C (Tmax=21)	77,33 €
DKT ZCC2 012 ZT.D	✓	✗	DKT ZCC2 32X32 4C (Tmax=25)	89,67 €
DKT ZCC2 013 ZT.D	✓	✓	DKT ZCC2 16X16 5C (Tmax=18)	71,00 €
DKT ZCC2 014 ZT.D	✓	✓	DKT ZCC2 20X20 5C (Tmax=21)	74,33 €
DKT ZCC2 015 ZT.D	✓	✓	DKT ZCC2 25X25 5C (Tmax=22)	77,33 €
DKT ZCC2 016 ZT.D	✓	✗	DKT ZCC2 32X32 5C (Tmax=25)	89,67 €
DKT ZCC2 017 ZT.D	✗	✗	DKT ZCC2 20X20 6C (Tmax=21)	74,33 €
DKT ZCC2 018 ZT.D	✓	✗	DKT ZCC2 25X25 6C (Tmax=22)	77,33 €
DKT ZCC2 019 ZT.D	✓	✗	DKT ZCC2 32X32 6C (Tmax=25)	89,67 €
DKT ZCC2 020 ZT.D	✓	✓	DKT ZCC2 20X20 2,5C (Tmax=22)	74,33 €
DKT ZCC2 021 ZT.D	✓	✓	DKT ZCC2 16X16 2C (Tmax=17)	71,00 €

DKT KYC



KOD	Stok / Stock		Kesici Uç Uyumluluđu / Insert Suitability	FİYAT PRICE
	R	L		EURO
DKT KY 001 GDM	✓	✗	DKT KY 12X12 2C (Tmax=12)	71,00 €
DKT KY 002 GDM	✓	✗	DKT KY 16X16 2C (Tmax=17)	71,00 €
DKT KY 003 GDM	✓	✗	DKT KY 20X20 2C (Tmax=17)	74,33 €
DKT KY 004 GDM	✓	✓	DKT KY 25X25 2C (Tmax=18)	77,33 €
DKT KY 005 GDM	✓	✗	DKT KY 12X12 3C (Tmax=12)	71,00 €
DKT KY 006 GDM	✓	✓	DKT KY 16X16 3C (Tmax=20)	71,00 €
DKT KY 007 GDM	✓	✓	DKT KY 20X20 3C (Tmax=20)	74,33 €
DKT KY 008 GDM	✓	✓	DKT KY 25X25 3C (Tmax=21)	77,33 €
DKT KY 009 GDM	✓	✗	DKT KY 16X16 4C (Tmax=17)	71,00 €
DKT KY 010 GDM	✓	✓	DKT KY 20X20 2C (Tmax=17)	74,33 €
DKT KY 011 GDM	✓	✗	DKT KY 25X25 2C (Tmax=10)	77,33 €
DKT KY 012 GDM	✓	✗	DKT KY 25X25 3C (Tmax=25)	77,33 €
DKT KY 013 GDM	✓	✗	DKT KY 25X25 4C (Tmax=25)	77,33 €

DKT SND



KOD	Stok / Stock		Kesici Uç Uyumluluđu / Insert Suitability	FİYAT PRICE
	R	L		EURO
DKT SND 001 SND	✓	✓	DKT SND 12X12 2C (Tmax=12)	71,00 €
DKT SND 002 SND	✓	✓	DKT SND 12X12 3C (Tmax=12)	71,00 €
DKT SND 003 SND	✓	✓	DKT SND 20X20 2C (Tmax=18)	74,33 €
DKT SND 004 SND	✓	✓	DKT SND 25X25 2C (Tmax=21)	77,33 €
DKT SND 007 SND	✓	✓	DKT SND 20X20 3C (Tmax=18)	74,33 €
DKT SND 008 SND	✓	✓	DKT SND 25X25 3C (Tmax=21)	77,33 €
DKT SND 011 SND	✓	✓	DKT SND 20X20 4C (Tmax=20)	74,33 €
DKT SND 012 SND	✓	✓	DKT SND 25X25 4C (Tmax=21)	77,33 €
DKT SND 014 SND	✓	✓	DKT SND 20X20 5C (Tmax=21)	74,33 €
DKT SND 015 SND	✓	✓	DKT SND 25X25 5C (Tmax=23)	77,33 €
DKT SND 016 SND	✓	✗	DKT SND 32X32 5C (Tmax=25)	89,67 €
DKT SND 019 SND	✓	✓	DKT SND 25X25 1,5C (Tmax=18)	77,33 €
DKT SND 020 SND	✓	✓	DKT SND 16X16 1,5C (Tmax=18)	71,00 €
DKT SND 021 SND	✓	✓	DKT SND 20X20 1,5C (Tmax=18)	74,33 €
DKT SND 022 SND	✓	✓	DKT SND 16X16 2C (Tmax=18)	71,00 €

DKT KM



KOD	Stok / Stock		Kesici Uç Uyumluluđu / Insert Suitability	FİYAT PRICE
	R	L		EURO
DKT KM 003 GMN	✓	✗	DKT KM 16X16 2C A4 GMN (Tmax=18)	71,00 €
DKT KM 004 GMN	✓	✗	DKT KM 20X20 2C A4 GMN (Tmax=18)	74,33 €
DKT KM 005 GMN	✓	✗	DKT KM 20X20 3C A4 GMN (Tmax=18)	74,33 €
DKT KM 006 GMN	✓	✗	DKT KM 20X20 4C A4 GMN (Tmax=18)	74,33 €
DKT KM 007 GMN	✓	✗	DKT KM 25X25 2C A4 GMN (Tmax=22)	77,33 €
DKT KM 008 GMN	✓	✗	DKT KM 25X25 3C A4 GMN (Tmax=22)	77,33 €
DKT KM 009 GMN	✓	✗	DKT KM 25X25 4C A4 GMN (Tmax=22)	77,33 €
DKT KM 010 GMN	✓	✗	DKT KM 25X25 5C A4 GMN (Tmax=22)	77,33 €
DKT KM 011 GMN	✓	✗	DKT KM 25X25 6C A4 GMN (Tmax=22)	77,33 €

DKT TNG



KOD	Stok / Stock		Kesici Uç Uyumluluđu / Insert Suitability	FIYAT
	R	L		PRICE
				EURO
DKT TNG 001 TNG	✓	✓	DKT TNG 16X16 2C (Tmax=17)	71,00 €
DKT TNG 002 TNG	✓	✓	DKT TNG 20X20 2C (Tmax=20)	74,33 €
DKT TNG 003 TNG	✓	✓	DKT TNG 25X25 2C (Tmax=22)	77,33 €

DKT VG



KOD	Stok / Stock		Kesici Uç Uyumluluđu / Insert Suitability	FIYAT
	R	L		PRICE
				EURO
DKT VG 001 VRG	✓	✗	DKT VG 20X20 2C (Tmax=20)	74,33 €
DKT VG 002 VRG	✓	✗	DKT VG 20X20 3C (Tmax=20)	74,33 €
DKT VG 003 VRG	✓	✗	DKT VG 25X25 2C (Tmax=22)	77,33 €
DKT VG 004 VRG	✓	✗	DKT VG 25X25 3C (Tmax=22)	77,33 €
DKT VG 005 VRG	✓	✗	DKT VG 25X25 4C (Tmax=22)	77,33 €
DKT VG 006 VRG	✓	✗	DKT VG 32X32 3C (Tmax=24)	89,67 €
DKT VG 007 VRG	✓	✗	DKT VG 32X32 4C (Tmax=24)	89,67 €

DKT H 360



KOD	Stok / Stock	Kesici Uç Uyumluluđu / Insert Suitability	FIYAT
			PRICE
			EURO
DKT H 360 001 S312	✓	DKT H 360 16X16 1C	71,00 €
DKT H 360 002 S312	✓	DKT H 360 20X20 1C	74,33 €
DKT H 360 003 S312	✓	DKT H 360 25X25 1C	77,33 €
DKT H 360 004 S312	✓	DKT H 360 16X16 2C	71,00 €
DKT H 360 005 S312	✓	DKT H 360 20X20 2C	74,33 €
DKT H 360 006 S312	✓	DKT H 360 25X25 2C	77,33 €
DKT H 360 007 S312	✓	DKT H 360 16X16 3C	71,00 €
DKT H 360 008 S312	✓	DKT H 360 20X20 3C	74,33 €
DKT H 360 009 S312	✓	DKT H 360 25X25 3C	77,33 €

ALIN KANAL KATERİ



KOD	Stok / Stock		Kesici Uç Uyumluluđu / Insert Suitability	FIYAT PRICE
	R	L		EURO
AKT K 001 KRLY MGM	✓	✗	AKT K 25X25 3C (30-40) (Tmax=17)	108,33 €
AKT K 002 KRLY MGM	✓	✗	AKT K 25X25 3C (35-50) (Tmax=17)	108,33 €
AKT K 003 KRLY MGM	✓	✗	AKT K 25X25 3C (45-70) (Tmax=17)	108,33 €
AKT K 004 KRLY MGM	✓	✗	AKT K 25X25 3C (65-105) (Tmax=17)	108,33 €
AKT K 005 KRLY MGM	✓	✗	AKT K 25X25 3C (100-150) (Tmax=17)	108,33 €
AKT K 006 KRLY MGM	✓	✗	AKT K 25X25 4C (30-40) (Tmax=17)	108,33 €
AKT K 007 KRLY MGM	✓	✗	AKT K 25X25 4C (35-50) (Tmax=17)	108,33 €
AKT K 008 KRLY MGM	✓	✗	AKT K 25X25 4C (45-70) (Tmax=17)	108,33 €
AKT K 009 KRLY MGM	✓	✗	AKT K 25X25 4C (65-105) (Tmax=17)	108,33 €
AKT K 010 KRLY MGM	✓	✗	AKT K 25X25 4C (100-150) (Tmax=17)	108,33 €
AKT K 011 KRLY MGM	✓	✗	AKT K 25X25 5C (75-110) (Tmax=20)	108,33 €
AKT K 012 KRLY MGM	✓	✗	AKT K 25X25 5C (105-150) (Tmax=20)	108,33 €
AKT K 013 KRLY MGM	✓	✗	AKT K 25X25 5C (145-200) (Tmax=20)	108,33 €

ALIN KANAL KATERİ



KOD	Stok / Stock		Kesici Uç Uyumluluđu / Insert Suitability	FIYAT PRICE
	R	L		EURO
AKT ZCC 001	✓	✗	AKT ZCC 25X25 3C (25-35) (Tmax=17)	108,33 €
AKT ZCC 002	✓	✗	AKT ZCC 25X25 3C (35-45) (Tmax=17)	108,33 €
AKT ZCC 003	✓	✗	AKT ZCC 25X25 3C(39-55) (Tmax=17)	108,33 €
AKT ZCC 004	✓	✗	AKT ZCC 25X25 3C (49-80) (Tmax=17)	108,33 €
AKT ZCC 005	✓	✗	AKT ZCC 25X25 3C (70-110) (Tmax=17)	108,33 €
AKT ZCC 006	✓	✗	AKT ZCC 25X25 3C (100-150) (Tmax=17)	108,33 €
AKT ZCC 007	✓	✗	AKT ZCC 25X25 4C (40-60) (Tmax=22)	108,33 €
AKT ZCC 008	✓	✗	AKT ZCC 25X25 4C (52-80) (Tmax=22)	108,33 €
AKT ZCC 009	✓	✗	AKT ZCC 25X25 4C (72-110) (Tmax=22)	108,33 €
AKT ZCC 010	✓	✗	AKT ZCC 25X25 4C (100-150) (Tmax=22)	108,33 €
AKT ZCC 011	✓	✗	AKT ZCC 25X25 4C (140-200) (Tmax=22)	108,33 €
AKT ZCC 012	✓	✗	AKT ZCC 25X25 5C (55-95) (Tmax=25)	108,33 €
AKT ZCC 013	✓	✗	AKT ZCC 25X25 5C (85-140) (Tmax=25)	108,33 €
AKT ZCC 014	✓	✗	AKT ZCC 25X25 5C (130-200) (Tmax=25)	108,33 €
AKT ZCC 015	✓	✓	AKT ZCC 25X25 L 3C (70-110) (Tmax=25)	108,33 €
AKT ZCC 016	✓	✗	AKT ZCC 25X25 6C T32 (88-180)	158,00 €
AKT ZCC 017	✗	✓	AKT ZCC 25X25 L 6C T38 (120-240)	158,00 €
AKT ZCC 018	✗	✓	AKT ZCC 25X25 L 3C TMAX10 (70-110)	108,33 €

ALIN KANAL KATERİ



KOD	Stok / Stock		Kesici Uç Uyumluluđu / Insert Suitability	FIYAT PRICE
	R	L		EURO
LKT K 001 KRLY MGMN	✓	✗	LKT K 25X25 3C (30-40) Tmax: 14	108,33 €
LKT K 002 KRLY MGMN	✓	✗	LKT K 25X25 3C (35-50) Tmax: 14	108,33 €
LKT K 003 KRLY MGMN	✓	✗	LKT K 25X25 3C (45-70) Tmax: 14	108,33 €
LKT K 004 KRLY MGMN	✓	✗	LKT K 25X25 3C (65-105) Tmax: 14	108,33 €
LKT K 005 KRLY MGMN	✓	✗	LKT K 25X25 3C (100-150) Tmax: 14	108,33 €
LKT K 006 KRLY MGMN	✓	✗	LKT K 25X25 3C (150-200) Tmax: 14	108,33 €
LKT K 007 KRLY MGMN	✓	✗	LKT K 25X25 3C (200-300) Tmax: 14	108,33 €
LKT K 008 KRLY MGMN	✓	✗	LKT K 25X25 3C (300-500) Tmax: 14	108,33 €
LKT K 009 KRLY MGMN	✓	✗	LKT K 25X25 4C (35-50) Tmax: 17	108,33 €
LKT K 010 KRLY MGMN	✓	✗	LKT K 25X25 4C (45-70) Tmax: 17	108,33 €
LKT K 011 KRLY MGMN	✓	✗	LKT K 25X25 4C (65-105) Tmax: 17	108,33 €
LKT K 012 KRLY MGMN	✓	✗	LKT K 25X25 4C (100-150) Tmax: 17	108,33 €
LKT K 013 KRLY MGMN	✓	✗	LKT K 25X25 4C (150-200) Tmax: 17	108,33 €

**DKT I
KAYAR OTOMAT**



KOD	Stok / Stock		Kesici Uç Uyumluluğu / Insert Suitability	FIYAT PRICE
	R	L		EURO
DKT I 004 DGN KAYAR OT	✓	✓	DKT I 12X12 2C KAYAR OTOMAT (Tmax=12)	71,00 €
DKT I 005 DGN KAYAR OT	✓	✓	DKT I 16X16 2C KAYAR OTOMAT (Tmax=15)	71,00 €
DKT I 006 DGN KAYAR OT	✓	✓	DKT I 16X16 3C KAYAR OTOMAT (Tmax=15)	74,33 €
DKT I 007 DGN KAYAR OT	✓	✓	DKT I 12X12 3C KAYAR OTOMAT (Tmax=12)	71,00 €

**DKT SND
KAYAR OTOMAT**



KOD	Stok / Stock		Kesici Uç Uyumluluğu / Insert Suitability	FIYAT PRICE
	R	L		EURO
DKT SND 001 N123 OT	✓	✓	DKT SND 12X12 1.5C OTOMAT (Tmax:12)	71,00 €
DKT SND 002 N123 OT	✓	✓	DKT SND 16X16 1.5C OTOMAT (Tmax:15)	74,33 €
DKT SND 003 N123 OT	✓	✓	DKT SND 12X12 2C OTOMAT (Tmax:12)	71,00 €
DKT SND 005 N123 OT	✓	✓	DKT SND 12X12 3C OTOMAT (Tmax:12)	71,00 €

**DKT KYC
KAYAR OTOMAT**



KOD	Stok / Stock		Kesici Uç Uyumluluğu / Insert Suitability	FIYAT PRICE
	R	L		EURO
DKT KY 001 GDM OT	✓	✓	DKT KY 10X10 2C OTOMAT (Tmax:12)	71,00 €
DKT KY 002 GDM OT	✓	✓	DKT KY 12X12 2C OTOMAT (Tmax:12)	71,00 €
DKT KY 003 GDM OT	✓	✓	DKT KY 16X16 2C OTOMAT (Tmax:15)	74,33 €
DKT KY 004 GDM OT	✓	✓	DKT KY 12X12 3C OTOMAT (Tmax:12)	71,00 €
DKT KY 005 GDM OT	✓	✓	DKT KY 16X16 3C OTOMAT (Tmax:15)	74,33 €

**DKT KYC
KAYAR OTOMAT**

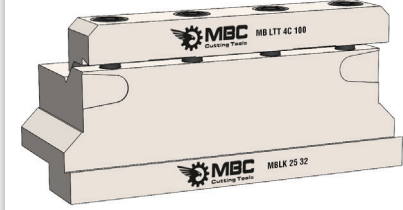

KOD	Stok / Stock		Kesici Uç Uyumluluğu / Insert Suitability	FIYAT PRICE
	R	L		EURO
DKT ZCC2 003 KAYAR OT	✓	✓	DKT ZCC2 12X12 2C KAYAR OTOMAT(Tmax:12)	71,00 €
DKT ZCC2 004 KAYAR OT	✓	✓	DKT ZCC2 16X16 2C KAYAR OTOMAT(Tmax:15)	74,33 €
DKT ZCC2 005 KAYAR OT	✓	✓	DKT ZCC2 16X16 3C KAYAR OTOMAT(Tmax:15)	74,33 €
DKT ZCC2 006 KAYAR OT	✓	✓	DKT ZCC 12X12 3C R KAYAR OTOMAT(Tmax:12)	71,00 €

LTT

KOD	Stok / Stock	Kesici Uç Uyumluluğu / Insert Suitability	FIYAT PRICE
		LTT	EURO
LTT 001	✓	20x26 LAMA TUTUCU TAKIM	131,75 €
LTT 002	✓	20x32 LAMA TUTUCU TAKIM	131,75 €
LTT 003	✓	25x26 LAMA TUTUCU TAKIM	142,75 €
LTT 004	✓	25x32 LAMA TUTUCU TAKIM	142,75 €
LTT 005	✓	32x32 LAMA TUTUCU TAKIM	153,70 €

MBL I

KOD	Stok / Stock	Kesici Uç Uyumluluğu / Insert Suitability	FIYAT PRICE
		MBL I	EURO
MBL I 002	✓	MBL I 26 3C	80,00 €
MBL I 003	✓	MBL I 32 3C	90,00 €

MBL K



KOD	Stok / Stock	Kesici Uç Uyumluluğu / Insert Suitability		FIYAT PRICE
		MBL KRLY MGM		EURO
MBL K 002	✓	MBL K 26 3C		80,00 €
MBL K 003	✓	MBL K 26 3C		80,00 €
MBL K 004	✓	MBL K 26 4C		80,00 €
MBL K 005	✓	MBL K 32 2C		90,00 €
MBL K 006	✓	MBL K 32 3C		90,00 €
MBL K 007	✓	MBL K 32 4C		90,00 €

MBL ZCC



KOD	Stok / Stock	Kesici Uç Uyumluluğu / Insert Suitability		FIYAT PRICE
		MBL ZCC ZT.D		EURO
MBL ZCC 002	✓	MBL ZCC 26 3C		80,00 €
MBL ZCC 003	✓	MBL ZCC 32 3C		90,00 €



İÇ KANAL KATERLERİ

INTERNAL GROOVING TOOLHOLDERS



KOD	Stok / Stock	Kesici Uç Uyumluluğu / Insert Suitability	FİYAT PRICE
		KRLY MGM	EURO
IKT K 001 MGM	✓	IKT K 16 2C (Tmax=4)	65,00 €
IKT K 002 MGM	✓	IKT K 20 2C (Tmax=4)	68,00 €
IKT K 003 MGM	✓	IKT K 25 2C (Tmax=5,5)	74,33 €
IKT K 004 MGM	✓	IKT K 32 2C (Tmax=6)	78,67 €
IKT K 005 MGM	✓	IKT K 20 3C (Tmax=4,5)	68,00 €
IKT K 006 MGM	✓	IKT K 25 3C (Tmax=6)	74,33 €
IKT K 007 MGM	✓	IKT K 32 3C (Tmax=9)	78,67 €
IKT K 008 MGM	✓	IKT K 20 4C (Tmax=4,5)	68,00 €
IKT K 009 MGM	✓	IKT K 25 4C (Tmax=6)	74,33 €
IKT K 010 MGM	✓	IKT K 32 4C (Tmax=9)	78,67 €
IKT K 011 MGM	✓	IKT K 40 3C (Tmax=10)	130,00 €
IKT K 012 MGM	✓	IKT K 40 4C (Tmax=10)	130,00 €
IKT K 013 MGM	✓	IKT K 40 5C (Tmax=10)	130,00 €
IKT K 014 MGM	✓	IKT K 32 5C (Tmax=9)	78,67 €
IKT K 015 MGM	✓	IKT K 25 5C (Tmax=6)	74,33 €

KOD	Stok / Stock	Kesici Uç Uyumluluğu / Insert Suitability	FİYAT PRICE
		I DGN.	EURO
IKT I 001 DGN.	✓	IKT I 20 2C (Tmax=4,5)	68,00 €
IKT I 002 DGN.	✓	IKT I 25 2C (Tmax=6)	74,33 €
IKT I 003 DGN.	✓	IKT I 32 2C (Tmax=8,5)	78,67 €
IKT I 004 DGN.	✓	IKT I 20 3C (Tmax=4,5)	68,00 €
IKT I 005 DGN.	✓	IKT I 25 3C (Tmax=6)	74,33 €
IKT I 006 DGN.	✓	IKT I 32 3C (Tmax=8,5)	78,67 €
IKT I 007 DGN.	✓	IKT I 20 4C (Tmax=4,5)	68,00 €
IKT I 008 DGN.	✓	IKT I 25 4C (Tmax=6)	74,33 €
IKT I 009 DGN.	✓	IKT I 32 4C (Tmax=8,5)	78,67 €

KOD	Stok / Stock	Kesici Uç Uyumluluğu / Insert Suitability	FİYAT PRICE
		HRN S224	EURO
IKT HK 001 S224	✓	IKT HK 20 2C (Tmax=4,5)	68,00 €
IKT HK 002 S224	✓	IKT HK 25 2C (Tmax=6,5)	74,33 €
IKT HK 003 S224	✓	IKT HK 32 2C (Tmax=7)	78,67 €
IKT HK 004 S224	✓	IKT HK 20 3C (Tmax=4,5)	68,00 €
IKT HK 005 S224	✓	IKT HK 25 3C (Tmax=6,5)	74,33 €
IKT HK 006 S224	✓	IKT HK 32 3C (Tmax=7)	78,67 €
IKT HK 007 S224	✓	IKT HK 20 4C (Tmax=4,5)	68,00 €
IKT HK 008 S224	✓	IKT HK 25 4C (Tmax=6,5)	74,33 €
IKT HK 009 S224	✓	IKT HK 32 4C (Tmax=7)	78,67 €

IKT H



IKT ZCC2



IKT SND



I GRP



KOD	Stok / Stock	Kesici Uç Uyumluluğu / Insert Suitability		FIYAT PRICE
		HRN S229		EURO
IKT H 001 S229	✓	IKT H 25 3C (Tmax=8)		74,33 €
IKT H 002 S229	✓	IKT H 32 3C (Tmax=10)		78,67 €
IKT H 003 S229	✓	IKT H 40 3C (Tmax=10)		130,00 €
IKT H 004 S229	✓	IKT H 25 4C (Tmax=8)		74,33 €
IKT H 005 S229	✓	IKT H 32 4C (Tmax=10)		78,67 €
IKT H 006 S229	✓	IKT H 40 4C (Tmax=10)		130,00 €
IKT H 007 S229	✓	IKT H 25 5C (Tmax=8)		74,33 €
IKT H 008 S229	✓	IKT H 32 5C (Tmax=10)		78,67 €
IKT H 009 S229	✓	IKT H 40 5C (Tmax=10)		130,00 €

KOD	Stok / Stock	Kesici Uç Uyumluluğu / Insert Suitability		FIYAT PRICE
		ZCC ZT.D		EURO
IKT ZCC2 001 ZT.D	✓	IKT ZCC2 20 3C (Tmax=4,5)		68,00 €
IKT ZCC2 002 ZT.D	✓	IKT ZCC2 25 3C (Tmax=6)		74,33 €
IKT ZCC2 003 ZT.D	✓	IKT ZCC2 32 3C (Tmax=8)		78,67 €
IKT ZCC2 004 ZT.D	✓	IKT ZCC2 25 4C (Tmax=6)		74,33 €
IKT ZCC2 005 ZT.D	✓	IKT ZCC2 32 4C (Tmax=9)		78,67 €
IKT ZCC2 006 ZT.D	✓	IKT ZCC2 32 5C (Tmax=9)		78,67 €
IKT ZCC2 007 ZT.D	✓	IKT ZCC2 40 5C (Tmax=10)		130,00 €
IKT ZCC2 008 ZT.D	✓	IKT ZCC2 25 2C (Tmax=6)		74,33 €
IKT ZCC2 009 ZT.D	✓	IKT ZCC2 16 2C (Tmax=4)		65,00 €
IKT ZCC2 010 ZT.D	✓	IKT ZCC2 20 2C (Tmax=4,5)		68,00 €

KOD	Stok / Stock	Kesici Uç Uyumluluğu / Insert Suitability		FIYAT PRICE
		SND ZCC		EURO
IKT SND 001 SND	✓	IKT SND 20 3C N123 (Tmax=4,5)		68,00 €
IKT SND 002 SND	✓	IKT SND 25 3C N123 (Tmax=6)		74,33 €
IKT SND 003 SND	✓	IKT SND 32 3C N123 (Tmax=9)		78,67 €
IKT SND 004 SND	✓	IKT SND 25 4C N123 (Tmax=6)		74,33 €
IKT SND 005 SND	✓	IKT SND 32 4C N123 (Tmax=9)		78,67 €
IKT SND 007 SND	✓	IKT SND 20 2C N123 (Tmax=4,5)		68,00 €
IKT SND 008 SND	✓	IKT SND 25 2C N123 (Tmax=6)		74,33 €

KOD	Stok / Stock	Kesici Uç Uyumluluğu / Insert Suitability		FIYAT PRICE
		GRP I		EURO
IKT I GRP 001	✓	IKT I GRP 16 3C (Tmax=4)		65,00 €
IKT I GRP 002	✓	IKT I GRP 20 3C (Tmax=4)		68,00 €
IKT I GRP 003	✓	IKT I GRP 25 3C (Tmax=5,5)		74,33 €

IKT ITG



KOD	Stok / Stock	Kesici Uç Uyumluluğu / Insert Suitability		FİYAT PRICE
		IKT ITG		EURO
IKT ITG 001 TGM.	✓	IKT ITG 16 3C (R) (Tmax=4)		65,00 €
IKT ITG 003 TGM.	✓	IKT ITG 20 3C (R) (Tmax=4)		68,00 €
IKT ITG 005 TGM.	✓	IKT ITG 25 3C (R) (Tmax=5,5)		74,33 €
IKT ITG 007 TGM.	✓	IKT ITG 25 4C (R) (Tmax=5,5)		74,33 €
IKT ITG 009 TGM.	✓	IKT ITG 32 3C (R) (Tmax=9)		78,67 €
IKT ITG 011 TGM.	✓	IKT ITG 32 4C (R) (Tmax=9)		78,67 €

IKT KY



KOD	Stok / Stock	Kesici Uç Uyumluluğu / Insert Suitability		FİYAT PRICE
		IKT KY		EURO
IKT KY 001 GDM	✓	IKT KY 20 2C (Tmax=4)		68,00 €
IKT KY 002 GDM	✓	IKT KY 20 3C (Tmax=4)		68,00 €
IKT KY 003 GDM	✓	IKT KY 25 3C (Tmax=5,5)		74,33 €
IKT KY 004 GDM	✓	IKT KY 32 3C (Tmax=9)		78,67 €
IKT KY 005 GDM	✓	IKT KY 32 4C (Tmax=9)		78,67 €
IKT KY 006 GDM	✓	IKT KY 40 4C (Tmax=10)		130,00 €
IKT KY 007 GDM	✓	IKT KY 25 4C TMAX 12		74,33 €
IKT KY 008 GDM	✓	IKT KY 32 4C TMAX 12		78,67 €
IKT KY 009 GDM	✓	IKT KY 25 2C TMAX 5		74,33 €
IKT KY 010 GDM	✓	IKT KY 18X16 2C T4,5		68,00 €
IKT KY 011 GDM	✓	IKT KY 18X16 3C T4,5		68,00 €
IKT KY 012 GDM	✓	IKT KY 20X16 2C (Tmax=4)		68,00 €
IKT KY 013 GDM	✓	IKT KY 20X16 3C (Tmax=4)		68,00 €
IKT KY 015 GDM	✓	IKT KY 20 4C T5.5		80,33 €
IKT KY 016 GDM	✓	IKT KY 25 4C TMAX 6		74,33 €

IKT VG



KOD	Stok / Stock	Kesici Uç Uyumluluğu / Insert Suitability		FİYAT PRICE
		IKT VG		EURO
IKT VG 001 VRG	✓	IKT VG 20 2C (Tmax=4)		68,00 €
IKT VG 002 VRG	✓	IKT VG 20 3C (Tmax=4)		68,00 €
IKT VG 003 VRG	✓	IKT VG 25 2C (Tmax=5,5)		74,33 €
IKT VG 004 VRG	✓	IKT VG 25 3C (Tmax=5,5)		74,33 €
IKT VG 005 VRG	✓	IKT VG 25 4C (Tmax=5,5)		74,33 €
IKT VG 006 VRG	✓	IKT VG 32 2C (Tmax=9)		78,67 €
IKT VG 007 VRG	✓	IKT VG 32 3C (Tmax=9)		78,67 €
IKT VG 008 VRG	✓	IKT VG 32 4C (Tmax=9)		78,67 €



S-SİSTEM DIŞ ÇAP TORNALAMA KATERLER

S-SYSTEM EXTERNAL TURNING TOOLHOLDERS

SVJBR ISO



93°

SVVBN ISO



62,5°

SVHBR ISO



107,5°

SVJCR ISO



93°

KOD	Stok / Stock		Kesici Uç Uyumluluğu / Insert Suitability	FIYAT
	R	L		PRICE
			ISO	EURO
SVJBR 001 ISO	✓	✓	SVJBR 12X12 H11	42,33 €
SVJBR 002 ISO	✓	✓	SVJBR 16X16 H11	47,67 €
SVJBR 003 ISO	✓	✓	SVJBR 16X16 H16	51,00 €
SVJBR 004 ISO	✓	✓	SVJBR 20X20 K11	51,00 €
SVJBR 005 ISO	✓	✓	SVJBR 20X20 K16	52,67 €
SVJBR 006 ISO	✓	✓	SVJBR 25X25 M16	54,33 €
SVJBR 007 ISO	✓	✓	SVJBR 32X32 P16	63,33 €
SVJBR 008 ISO	✓	✓	SVJBR 25X25 M11	52,67 €
SVJBR 011 ISO	✗	✗	SVJBR 12X12 K11	42,33 €

KOD	Stok / Stock		Kesici Uç Uyumluluğu / Insert Suitability	FIYAT
	R	L		PRICE
			ISO	EURO
SVVBN 001 ISO	✓		SVVBN 12X12 H11	42,33 €
SVVBN 002 ISO	✓		SVVBN 16X16 H11	47,67 €
SVVBN 003 ISO	✓		SVVBN 20X20 K11	51,00 €
SVVBN 004 ISO	✓		SVVBN 16X16 H16	51,00 €
SVVBN 006 ISO	✓		SVVBN 20X20 K16	52,67 €
SVVBN 007 ISO	✓		SVVBN 25X25 M16	54,33 €
SVVBN 008 ISO	✓		SVVBN 32X32 P16	63,33 €

KOD	Stok / Stock		Kesici Uç Uyumluluğu / Insert Suitability	FIYAT
	R	L		PRICE
			ISO	EURO
SVHBR 000 ISO	✗	✗	SVHBR 12X12 H11	42,33 €
SVHBR 001 ISO	✓	✓	SVHBR 16X16 H11	47,67 €
SVHBR 002 ISO	✓	✓	SVHBR 20X20 K11	51,00 €
SVHBR 003 ISO	✓	✓	SVHBR 20X20 K16	52,67 €
SVHBR 004 ISO	✓	✓	SVHBR 25X25 M16	54,33 €
SVHBR 005 ISO	✓	✓	SVHBR 32X32 P16	63,33 €

KOD	Stok / Stock		Kesici Uç Uyumluluğu / Insert Suitability	FIYAT
	R	L		PRICE
			ISO	EURO
SVJCR 001 ISO	✓	✓	SVJCR 12X12 H11	42,33 €
SVJCR 002 ISO	✓	✓	SVJCR 16X16 H11	47,67 €
SVJCR 003 ISO	✓	✓	SVJCR 16X16 H16	51,00 €
SVJCR 004 ISO	✓	✓	SVJCR 20X20 K11	51,00 €
SVJCR 005 ISO	✓	✓	SVJCR 20X20 K16	52,67 €
SVJCR 006 ISO	✓	✓	SVJCR 25X25 M16	54,33 €
SVJCR 007 ISO	✓	✓	SVJCR 32X32 P16	63,33 €

SVVCN ISO



72,5°

SDNCN ISO



62,5°

SDJCR ISO



93°

SCLCR ISO



95°

KOD	Stok / Stock	Kesici Uç Uyumluluğu / Insert Suitability		FİYAT PRICE
		ISO		EURO
SVVCN 001 ISO	✓	SVVCN 12X12 H11		42,33 €
SVVCN 002 ISO	✓	SVVCN 16X16 H11		42,33 €
SVVCN 003 ISO	✓	SVVCN 20X20 K11		51,00 €
SVVCN 004 ISO	✓	SVVCN 16X16 H16		51,00 €
SVVCN 005 ISO	✓	SVVCN 20X20 K16		51,00 €
SVVCN 006 ISO	✓	SVVCN 25X25 M16		54,33 €
SVVCN 007 ISO	✓	SVVCN 32X32 P16		63,33 €

KOD	Stok / Stock	Kesici Uç Uyumluluğu / Insert Suitability		FİYAT PRICE
		ISO		EURO
SDNCN 001 ISO	✓	SDNCN 8X8 H07		42,33 €
SDNCN 002 ISO	✓	SDNCN 10X10 H07		42,33 €
SDNCN 003 ISO	✓	SDNCN 12X12 H07		42,33 €
SDNCN 004 ISO	✓	SDNCN 16X16 H07		47,67 €
SDNCN 005 ISO	✓	SDNCN 16X16 H11		47,67 €
SDNCN 006 ISO	✓	SDNCN 20X20 K11		51,00 €
SDNCN 007 ISO	✓	SDNCN 25X25 M11		54,33 €
SDNCN 008 ISO	✓	SDNCN 32X32 P11		63,33 €
SDNCN 009 ISO	✓	SDNCN 12X12 M11		42,33 €

KOD	Stok / Stock		Kesici Uç Uyumluluğu / Insert Suitability		FİYAT PRICE
	R	L	ISO		EURO
SDJCR 001 ISO	✓	✓	SDJCR 8X8 H07		42,33 €
SDJCR 002 ISO	✓	✓	SDJCR 10X10 H07		42,33 €
SDJCR 003 ISO	✓	✓	SDJCR 12X12 H07		42,33 €
SDJCR 004 ISO	✓	✓	SDJCR 16X16 H07		47,67 €
SDJCR 005 ISO	✓	✓	SDJCR 16X16 H11		47,67 €
SDJCR 006 ISO	✓	✓	SDJCR 20X20 K11		51,00 €
SDJCR 007 ISO	✓	✓	SDJCR 25X25 M11		54,33 €
SDJCR 008 ISO	✓	✓	SDJCR 32X32 P11		63,33 €

KOD	Stok / Stock		Kesici Uç Uyumluluğu / Insert Suitability		FİYAT PRICE
	R	L	ISO		EURO
SCLCR 001 ISO	✓	✓	SCLCR 8X8 H06		42,33 €
SCLCR 002 ISO	✓	✓	SCLCR 10X10 H06		42,33 €
SCLCR 003 ISO	✓	✓	SCLCR 12X12 H06		42,33 €
SCLCR 004 ISO	✓	✓	SCLCR 16X16 H06		47,67 €
SCLCR 005 ISO	✓	✓	SCLCR 16X16 H09		47,67 €
SCLCR 006 ISO	✓	✓	SCLCR 20X20 K09		51,00 €
SCLCR 007 ISO	✓	✓	SCLCR 25X25 M09		54,33 €
SCLCR 008 ISO	✓	✓	SCLCR 16X16 H12		47,67 €
SCLCR 009 ISO	✓	✓	SCLCR 20X20 K12		51,00 €
SCLCR 010 ISO	✓	✓	SCLCR 25X25 M12		54,33 €
SCLCR 011 ISO	✓	✓	SCLCR 32X32 P12		63,33 €
SCLCR 012 ISO	✓	✓	SCLCR 12X12 H09		42,33 €

SCNCN ISO



50°

KOD	Stok / Stock		Kesici Uç Uyumluluğu / Insert Suitability		FİYAT PRICE
			ISO		EURO
SCNCN 001 ISO	✓		SCNCN 8X8 H06		42,33 €
SCNCN 002 ISO	✓		SCNCN 10X10 H06		42,33 €
SCNCN 004 ISO	✓		SCNCN 16X16 H09		47,67 €
SCNCN 005 ISO	✓		SCNCN 20X20 K09		51,00 €
SCNCN 006 ISO	✓		SCNCN 25X25 M12		54,33 €
SCNCN 008 ISO	✓		SCNCN 12X12 H06		42,33 €
SCNCN 009 ISO	✓		SCNCN 12X12 H09		42,33 €

SRGCR ISO



KOD	Stok / Stock		Kesici Uç Uyumluluğu / Insert Suitability		FİYAT PRICE
	R	L	ISO		EURO
SRGCR 001 ISO	✓	✓	SRGCR 16X16 H08		47,67 €
SRGCR 002 ISO	✓	✓	SRGCR 20X20 K08		51,00 €
SRGCR 003 ISO	✓	✓	SRGCR 25X25 M08		54,33 €
SRGCR 004 ISO	✓	✓	SRGCR 16X16 H10		47,67 €
SRGCR 005 ISO	✓	✓	SRGCR 20X20 K10		51,00 €
SRGCR 006 ISO	✓	✓	SRGCR 25X25 M10		54,33 €
SRGCR 007 ISO	✓	✓	SRGCR 32X32 P10		63,33 €
SRGCR 008 ISO	✓	✓	SRGCR 16X16 H12		47,67 €
SRGCR 009 ISO	✓	✓	SRGCR 20X20 K12		51,00 €
SRGCR 010 ISO	✓	✓	SRGCR 25X25 M12		54,33 €
SRGCR 011 ISO	✓	✓	SRGCR 32X32 P12		63,33 €

SRDCN ISO



KOD	Stok / Stock		Kesici Uç Uyumluluğu / Insert Suitability		FİYAT PRICE
			ISO		EURO
SRDCN 001 ISO	✓		SRDCN 16X16 H08		47,67 €
SRDCN 002 ISO	✓		SRDCN 20X20 K08		51,00 €
SRDCN 003 ISO	✓		SRDCN 25X25 M08		54,33 €
SRDCN 004 ISO	✓		SRDCN 20X20 K10		51,00 €
SRDCN 005 ISO	✓		SRDCN 25X25 M10		54,33 €
SRDCN 006 ISO	✓		SRDCN 20X20 K12		51,00 €
SRDCN 007 ISO	✓		SRDCN 25X25 M12		54,33 €
SRDCN 008 ISO	✓		SRDCN 25X25 M16		54,33 €
SRDCN 009 ISO	✓		SRDCN 16X16 H10		47,67 €
SRDCN 010 ISO	✓		SRDCN 32X32 P10		63,33 €
SRDCN 011 ISO	✓		SRDCN 32X32 P12		63,33 €

SRHCR ISO



KOD	Stok / Stock		Kesici Uç Uyumluluğu / Insert Suitability		FİYAT PRICE
	R	L	ISO		EURO
SRHCR 001 ISO	✓	✗	SRHCR 16X16 H08		47,67 €
SRHCR 002 ISO	✓	✓	SRHCR 20X20 K08		51,00 €
SRHCR 003 ISO	✓	✓	SRHCR 25X25 M08		54,33 €
SRHCR 004 ISO	✓	✓	SRHCR 20X20 K10		51,00 €
SRHCR 005 ISO	✓	✓	SRHCR 25X25 M10		54,33 €
SRHCR 006 ISO	✓	✓	SRHCR 20X20 K12		51,00 €
SRHCR 007 ISO	✓	✓	SRHCR 25X25 M12		54,33 €
SRHCR 008 ISO	✗	✗	SRHCR 32X32 P12		63,33 €
SRHCR 009 ISO	✓	✗	SRHCR 16X16 K12		47,67 €

STFCR ISO



90°

STJCR ISO

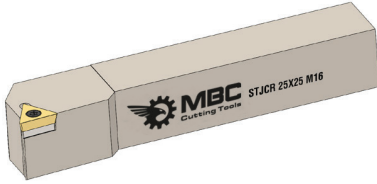

93°

DCMT 11 OTOMAT ISO



A90°-J93°

SER ISO



KOD	Stok / Stock		Kesici Uç Uyumluluğu / Insert Suitability	FIYAT
	R	L		PRICE
			ISO	EURO
STFCR 001 ISO	X	X	STFCR 16X16 H16	48,00 €
STFCR 002 ISO	✓	✓	STFCR 20X20 K16	51,00 €
STFCR 003 ISO	✓	✓	STFCR 25X25 M16	54,33 €
STFCR 004 ISO	✓	✓	STFCR 12X12 H11	42,33 €
STFCR 005 ISO	✓	✓	STFCR 16X16 H11	47,67 €

KOD	Stok / Stock		Kesici Uç Uyumluluğu / Insert Suitability	FIYAT
	R	L		PRICE
			ISO	EURO
STJCR 001 ISO	X	X	STJCR 16X16 H16	47,67 €
STJCR 002 ISO	✓	✓	STJCR 20X20 K16	51,00 €
STJCR 003 ISO	✓	✓	STJCR 25X25 M16	54,33 €

KOD	Stok / Stock		Kesici Uç Uyumluluğu / Insert Suitability	FIYAT
	R	L		PRICE
			ISO	EURO
OT SDACR 001 ISO	✓	✓	SDACR 12X12 K11	49,33 €
OT SDJCR 001 ISO	✓	✓	SDJCR 12X12 K11	49,33 €
OT SDJCR 002 ISO	✓	✓	SDJCR 16X16 H11	49,33 €
OT SDNCN 001 ISO	✓	✓	SDNCN 12X12 K11	49,33 €
STACR 001 ISO	✓	✓	STACR 12X12 H11	42,33 €

KOD	Stok / Stock		Kesici Uç Uyumluluğu / Insert Suitability	FIYAT
	R	L		PRICE
			ISO SER16	EURO
SER 003 ISO	✓	✓	SER 12X12 H11	47,67 €
SER 004 ISO	✓	✓	SER 12X12 H16	47,67 €
SER 005 ISO	✓	✓	SER 16X16 H11	49,33 €
SER 006 ISO	✓	✓	SER 16X16 K16	49,33 €
SER 007 ISO	✓	✓	SER 20X20 K16	52,67 €
SER 008 ISO	✓	✓	SER 25X25 M16	59,00 €
SER 009 ISO	✓	✓	SER 25X25 M22	59,00 €
SER 010 ISO	✓	✓	SER 32X32 P16	68,67 €
SER 011 ISO	✓	✓	SER 32X32 P22	68,67 €

SER ZCC



KOD	Kesici Uç Uyumluluğu / Insert Suitability		ZCC SER	FIYAT
	R	L		PRICE
SER 014 ZCC	✓	✓	SER 25X25 M22 U UTYPE	58,67 €
SER 015 ZCC	✓	✓	SER 25X25 M27 U UTYPE	58,67 €
SER 016 ZCC	✓	✓	SER 32X32 P22 U UTYPE	68,00 €

SIR ISO



KOD	Stok / Stock		Kesici Uç Uyumluluğu / Insert Suitability	ISO SIR16	FIYAT
	R	L			PRICE
SIR 001 ISO	✓	✓		S10K SIR 11	42,33 €
SIR 002 ISO	✓	✓		S12M SIR 11	42,33 €
SIR 003 ISO	✓	✓		S16-10 SIR 11	47,67 €
SIR 004 ISO	✓	✓		S16Q SIR 11	47,67 €
SIR 005 ISO	✓	✓		S16Q SIR 16	47,67 €
SIR 006 ISO	✓	✓		S20R SIR 16	51,00 €
SIR 007 ISO	✓	✓		S25S SIR 16	54,33 €
SIR 008 ISO	✓	✓		S32T SIR 16	75,67 €
SIR 009 ISO	✓	✓		S40V SIR 16	114,33 €
SIR 010 ISO	✓	✓		S25S SIR 22	55,67 €
SIR 011 ISO	✓	✓		S32T SIR 22	80,33 €
SIR 012 ISO	✓	✓		S40V SIR 22	117,67 €
SIR 013 ISO	✓	✓		S50W SIR 22	179,00 €
SIR 014 ISO	✓	✓		S60W SIR 22	222,33 €
SIR 015 ISO	✓	✓		S16-13Q SIR 16	47,67 €
SIR 016 ISO	✓	✓		S20R SIR 22	51,00 €
SIR 017 ISO	✓	✓		S20-16Q SIR 16	47,67 €

SIR ZCC



KOD	Stok / Stock		Kesici Uç Uyumluluğu / Insert Suitability	ZCC SIR	FIYAT
	R	L			PRICE
SIR 014 ZCC	✓	✗		SIR 0025 S22 U UTYPE	58,00 €
SIR 015 ZCC	✓	✗		SIR 0032 T22 U UTYPE	82,67 €
SIR 016 ZCC	✓	✗		SIR 0040 V22 U UTYPE	119,33 €
SIR 017 ZCC	✓	✗		SIR 0032 T27 U UTYPE	86,00 €
SIR 018 ZCC	✓	✗		SIR 0040 V27 U UTYPE	124,67 €



C-SİSTEM DIŞ ÇAP TORNALAMA KATERLERİ

C-SYSTEM EXTERNAL TURNING TOOLHOLDERS

CTGPR ISO



90°

CKJNR ISO



93°

TDJNR ISO



93°

TDNNN ISO



62,5°

KOD	Stok / Stock		Kesici Uç Uyumluluğu / Insert Suitability	FIYAT
	R	L		PRICE
			ISO	EURO
CTGPR 001 ISO	✓	✗	CTGPR 16X16 H11	52,67 €
CTGPR 002 ISO	✓	✗	CTGPR 16X16 H16	52,67 €
CTGPR 003 ISO	✓	✗	CTGPR 20X20 K16	54,33 €
CTGPR 004 ISO	✓	✗	CTGPR 25X25 M16	57,33 €
CTGPR 005 ISO	✓	✗	CTGPR 25X25 M22	57,33 €

KOD	Stok / Stock		Kesici Uç Uyumluluğu / Insert Suitability	FIYAT
	R	L		PRICE
			ISO	EURO
CKJNR 004 ISO	✓	✓	CKJNR 20X20 K16	54,33 €
CKJNR 006 ISO	✓	✓	CKJNR 25X25 M16	57,33 €
CKJNR 007 ISO	✓	✓	CKJNR 32X32 P16	77,33 €
CKJNR 008 ISO	✓	✓	CKJNR 40X40 R16	128,33 €

KOD	Stok / Stock		Kesici Uç Uyumluluğu / Insert Suitability	FIYAT
	R	L		PRICE
			ISO	EURO
TDJNR 001 ISO	✓	✓	TDJNR 16X16 K11	57,33 €
TDJNR 002 ISO	✓	✓	TDJNR 20X20 K11	65,00 €
TDJNR 003 ISO	✓	✓	TDJNR 25X25 M11	68,00 €
TDJNR 004 ISO	✓	✓	TDJNR 20X20 K15	65,00 €
TDJNR 005 ISO	✓	✓	TDJNR 25X25 M15	68,00 €
TDJNR 006 ISO	✓	✓	TDJNR 32X32 P15	80,33 €
TDJNR 007 ISO	✓	✓	TDJNR 40X40 R15	128,33 €
TDJNR 008 ISO	✓	✓	TDJNR 16X16 K15	57,33 €

KOD	Stok / Stock		Kesici Uç Uyumluluğu / Insert Suitability	FIYAT
	R	L		PRICE
			ISO	EURO
TDNNN 001 ISO	✓		TDNNN 16X16 H11	57,33 €
TDNNN 002 ISO	✓		TDNNN 20X20 K11	65,00 €
TDNNN 003 ISO	✓		TDNNN 25X25 M11	68,00 €
TDNNN 004 ISO	✓		TDNNN 20X20 K15	65,00 €
TDNNN 005 ISO	✓		TDNNN 25X25 M15	68,00 €
TDNNN 006 ISO	✓		TDNNN 32X32 P15	80,33 €
TDNNN 007 ISO	✓		TDNNN 40X40 R15	128,33 €

TTGNR ISO



90°

TTJNR ISO



93°

TSLNR ISO

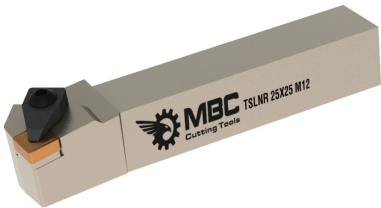

95°

TSKNR ISO



75°

KOD	Stok / Stock		Kesici Uç Uyumluluğu / Insert Suitability	FIYAT
	R	L		PRICE
			ISO	EURO
TTGNR 001 ISO	✓	✓	TTGNR 20X20 K16	65,00 €
TTGNR 002 ISO	✓	✓	TTGNR 25X25 M16	68,00 €
TTGNR 003 ISO	✓	✓	TTGNR 20X20 K22	68,00 €
TTGNR 004 ISO	✓	✓	TTGNR 25X25 M22	74,33 €
TTGNR 005 ISO	✓	✓	TTGNR 32X32 P22	81,00 €
TTGNR 006 ISO	✓	✓	TTGNR 40X40 R22	128,33 €

KOD	Stok / Stock		Kesici Uç Uyumluluğu / Insert Suitability	FIYAT
	R	L		PRICE
			ISO	EURO
TTJNR 001 ISO	✓	✓	TTJNR 16X16 H16	57,33 €
TTJNR 002 ISO	✓	✓	TTJNR 20X20 K16	65,00 €
TTJNR 003 ISO	✓	✓	TTJNR 25X25 M16	68,00 €
TTJNR 004 ISO	✓	✓	TTJNR 20X20 K22	68,00 €
TTJNR 005 ISO	✓	✓	TTJNR 25X25 M22	74,33 €
TTJNR 006 ISO	✓	✓	TTJNR 32X32 P22	81,00 €
TTJNR 007 ISO	✓	✓	TTJNR 40X40 R22	128,33 €

KOD	Stok / Stock		Kesici Uç Uyumluluğu / Insert Suitability	FIYAT
	R	L		PRICE
			ISO	EURO
TSLNR 001 ISO	✓	✓	TSLNR 20X20 K12	65,00 €
TSLNR 002 ISO	✓	✓	TSLNR 25X25 M12	68,00 €
TSLNR 003 ISO	✓	✓	TSLNR 32X32 P12	80,33 €
TSLNR 004 ISO	✓	✓	TSLNR 40X40 R19	138,67 €
TSLNR 005 ISO	✓	✓	TSLNR 32X32 P15	82,67 €
TSLNR 006 ISO	✓	✓	TSLNR 40X40 R15	138,67 €
TSLNR 007 ISO	✓	✓	TSLNR 32X32 P19	86,67 €

KOD	Stok / Stock		Kesici Uç Uyumluluğu / Insert Suitability	FIYAT
	R	L		PRICE
			ISO	EURO
TSKNR 001 ISO	✓	✓	TSKNR 20X20 K12	65,00 €
TSKNR 002 ISO	✓	✓	TSKNR 25X25 M12	68,00 €
TSKNR 005 ISO	✓	✓	TSKNR 32X32 P15	82,67 €
TSKNR 007 ISO	✓	✓	TSKNR 40X40 R19	138,67 €

TSRNR ISO



15°

TSDNN ISO



45°

TSSNR ISO



45°

TWLNR ISO



95°

KOD	Stok / Stock		Kesici Uç Uyumluluğu / Insert Suitability	FIYAT PRICE
	R	L	ISO	EURO
TSRNR 001 ISO	✓	✓	TSRNR 20X20 K12	65,00 €
TSRNR 002 ISO	✓	✓	TSRNR 25X25 M12	68,00 €
TSRNR 003 ISO	✓	✓	TSRNR 32X32 P15	82,67 €
TSRNR 004 ISO	✓	✓	TSRNR 40X40 R19	138,67 €
TSRNR 005 ISO	✓	✓	TSRNR 32X32 P12	80,33 €
TSRNR 006 ISO	✓	✓	TSRNR 32X32 P19	86,67 €
TSRNR 007 ISO	✓	✓	TSRNR 40X40 R15	138,67 €

KOD	Stok / Stock		Kesici Uç Uyumluluğu / Insert Suitability	FIYAT PRICE
	R	L	ISO	EURO
TSDNN 001 ISO	✓		TSDNN 20X20 K12	65,00 €
TSDNN 002 ISO	✓		TSDNN 25X25 M12	68,00 €
TSDNN 003 ISO	✓		TSDNN 32X32 P15	82,67 €
TSDNN 004 ISO	✓		TSDNN 40X40 R19	138,67 €
TSDNN 005 ISO	✓		TSDNN 32X32 P12	80,33 €
TSDNN 006 ISO	✓		TSDNN 32X32 P19	86,67 €
TSDNN 007 ISO	✓		TSDNN 40X40 R15	138,67 €

KOD	Stok / Stock		Kesici Uç Uyumluluğu / Insert Suitability	FIYAT PRICE
	R	L	ISO	EURO
TSSNR 001 ISO	✓	✓	TSSNR 20X20 K12	65,00 €
TSSNR 002 ISO	✓	✓	TSSNR 25X25 M12	68,00 €
TSSNR 003 ISO	✓	✓	TSSNR 32X32 P15	82,67 €
TSSNR 004 ISO	✓	✓	TSSNR 40X40 R19	138,67 €
TSSNR 005 ISO	✓	✓	TSSNR 32X32 P12	80,33 €
TSSNR 006 ISO	✓	✓	TSSNR 32X32 P19	86,67 €

KOD	Stok / Stock		Kesici Uç Uyumluluğu / Insert Suitability	FIYAT PRICE
	R	L	ISO	EURO
TWLNR 001 ISO	✓	✓	TWLNR 16X16 K06	57,33 €
TWLNR 002 ISO	✓	✓	TWLNR 20X20 K06	65,00 €
TWLNR 003 ISO	✓	✓	TWLNR 25X25 M06	68,00 €
TWLNR 004 ISO	✓	✓	TWLNR 20X20 K08	65,00 €
TWLNR 005 ISO	✓	✓	TWLNR 25X25 M08	68,00 €
TWLNR 006 ISO	✓	✓	TWLNR 32X32 P08	80,33 €
TWLNR 007 ISO	✓	✓	TWLNR 40X40 R08	128,33 €

TVJNR ISO



93°

KOD	Stok / Stock		Kesici Uç Uyumluluğu / Insert Suitability	FİYAT PRICE
	R	L		EURO
TVJNR 000 ISO	✓	✓	TVJNR 16X16 K16	57,33 €
TVJNR 001 ISO	✓	✓	TVJNR 20X20 K16	65,00 €
TVJNR 002 ISO	✓	✓	TVJNR 25X25 M16	68,00 €
TVJNR 003 ISO	✓	✓	TVJNR 32X32 P16	80,33 €
TVJNR 004 ISO	✓	✗	TVJNR 40X40 R16	128,33 €

TVNNN ISO



72,5°

KOD	Stok / Stock		Kesici Uç Uyumluluğu / Insert Suitability	FİYAT PRICE
	R	L		EURO
TVNNN 001 ISO	✓		TVNNN 20X20 K16	65,00 €
TVNNN 002 ISO	✓		TVNNN 25X25 M16	68,00 €
TVNNN 003 ISO	✓		TVNNN 32X32 P16	80,33 €
TVNNN 004 ISO	✓		TVNNN 40X40 R16	128,33 €

TCLNR ISO



95°

KOD	Stok / Stock		Kesici Uç Uyumluluğu / Insert Suitability	FİYAT PRICE
	R	L		EURO
TCLNR 001 ISO	✓	✓	TCLNR 20X20 K12	65,00 €
TCLNR 002 ISO	✓	✓	TCLNR 25X25 M12	68,00 €
TCLNR 003 ISO	✓	✓	TCLNR 32X32 P12	86,67 €
TCLNR 004 ISO	✓	✓	TCLNR 25X25 M16	68,00 €
TCLNR 005 ISO	✓	✓	TCLNR 32X32 P16	86,67 €
TCLNR 006 ISO	✓	✓	TCLNR 32X32 P19	99,00 €
TCLNR 007 ISO	✓	✓	TCLNR 40X40 R19	138,67 €
TCLNR 008 ISO	✓	✓	TCLNR 40X40 R16	138,67 €
TCLNR 009 ISO	✓	✓	TCLNR 16X16 H12	57,33 €

TCBNR ISO



75°

KOD	Stok / Stock		Kesici Uç Uyumluluğu / Insert Suitability	FIYAT
	R	L		PRICE
				EURO
TCBNR 001 ISO	✓	✓	TCBNR 25X25 M12	68,00 €
TCBNR 002 ISO	✓	✓	TCBNR 32X32 P19	86,67 €
TCBNR 003 ISO	✓	✓	TCBNR 40X40 R19	142,00 €
TCBNR 004 ISO	✓	✓	TCBNR 20X20 K12	65,00 €
TCBNR 005 ISO	✓	✓	TCBNR 32X32 P12	80,33 €
TCBNR 006 ISO	✓	✓	TCBNR 32X32 P16	86,67 €

TCKNR ISO



75°

KOD	Stok / Stock		Kesici Uç Uyumluluğu / Insert Suitability	FIYAT
	R	L		PRICE
				EURO
TCKNR 001 ISO	✓	✓	TCKNR 25X25 M12	68,00 €
TCKNR 002 ISO	✓	✓	TCKNR 25X25 M16	68,00 €
TCKNR 004 ISO	✓	✓	TCKNR 32X32 P16	80,33 €

TCZNN ISO



50°

KOD	Stok / Stock		Kesici Uç Uyumluluğu / Insert Suitability	FIYAT
	R	L		PRICE
				EURO
TCZNN 001 ISO	✓		TCZNN 20X20 K12	65,00 €
TCZNN 002 ISO	✓		TCZNN 25X25 M12	68,00 €
TCZNN 003 ISO	✓		TCZNN 32X32 P12	80,33 €
TCZNN 004 ISO	✓		TCZNN 32X32 P19	99,00 €
TCZNN 005 ISO	✓		TCZNN 40X40 R19	128,33 €
TCZNN 006 ISO	✓		TCZNN 32X32 P16	86,67 €

TCMNN ISO



40°

KOD	Stok / Stock		Kesici Uç Uyumluluğu / Insert Suitability	FIYAT
	R	L		PRICE
				EURO
TCMNN 001 ISO	✓		TCMNN 20X20 K12	65,00 €
TCMNN 002 ISO	✓		TCMNN 25X25 M12	68,00 €
TCMNN 003 ISO	✓		TCMNN 32X32 P12	80,33 €
TCMNN 004 ISO	✓		TCMNN 32X32 P19	99,00 €
TCMNN 005 ISO	✓		TCMNN 40X40 R19	138,67 €
TCMNN 006 ISO	✓		TCMNN 32X32 P16	99,00 €

MTJNR ISO



93°

MTENN ISO

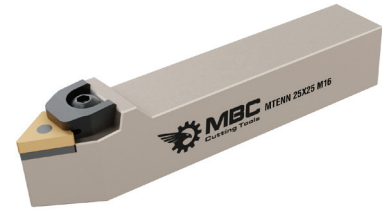

60°

MWLNR ISO



95°

MWDNN ISO



50°

KOD	Stok / Stock		Kesici Uç Uyumluluğu / Insert Suitability	FIYAT
	R	L		PRICE
				EURO
MTJNR 001 ISO	✓	✓	MTJNR 16X16 K16	57,33 €
MTJNR 002 ISO	✓	✓	MTJNR 20X20 K16	65,00 €
MTJNR 003 ISO	✓	✓	MTJNR 25X25 M16	68,00 €
MTJNR 004 ISO	✓	✓	MTJNR 32X32 P16	80,33 €
MTJNR 005 ISO	✓	✓	MTJNR 25X25 M22	68,00 €
MTJNR 006 ISO	✓	✓	MTJNR 32X32 P22	82,67 €
MTJNR 007 ISO	✓	✓	MTJNR 40X40 R22	128,33 €

KOD	Stok / Stock		Kesici Uç Uyumluluğu / Insert Suitability	FIYAT
	R	L		PRICE
				EURO
MTENN 001 ISO	✓		MTENN 16X16 K16	57,33 €
MTENN 002 ISO	✓		MTENN 20X20 K16	65,00 €
MTENN 003 ISO	✓		MTENN 25X25 M16	68,00 €
MTENN 004 ISO	✓		MTENN 32X32 P16	80,33 €
MTENN 005 ISO	✓		MTENN 25X25 M22	68,00 €
MTENN 006 ISO	✓		MTENN 32X32 P22	82,67 €
MTENN 007 ISO	✓		MTENN 40X40 R22	128,33 €

KOD	Stok / Stock		Kesici Uç Uyumluluğu / Insert Suitability	FIYAT
	R	L		PRICE
				EURO
MWLNR 001 ISO	✓	✓	MWLNR 16X16 H06	57,33 €
MWLNR 002 ISO	✓	✓	MWLNR 20X20 K06	65,00 €
MWLNR 003 ISO	✓	✓	MWLNR 25X25 M06	68,00 €
MWLNR 004 ISO	✓	✓	MWLNR 20X20 K08	65,00 €
MWLNR 005 ISO	✓	✓	MWLNR 25X25 M08	68,00 €
MWLNR 006 ISO	✓	✓	MWLNR 32X32 P08	80,33 €
MWLNR 007 ISO	✓	✓	MWLNR 40X40 R08	129,67 €

KOD	Stok / Stock		Kesici Uç Uyumluluğu / Insert Suitability	FIYAT
	R	L		PRICE
				EURO
MWDNN 001 ISO	✓		MWDNN 16X16 H06	57,33 €
MWDNN 002 ISO	✓		MWDNN 20X20 K06	65,00 €
MWDNN 003 ISO	✓		MWDNN 20X20 K08	65,00 €
MWDNN 004 ISO	✓		MWDNN 25X25 M08	68,00 €
MWDNN 005 ISO	✓		MWDNN 32X32 P08	80,33 €
MWDNN 006 ISO	✓		MWDNN 40X40 R08	129,67 €

PCLNR ISO



95°

KOD	Stok / Stock		Kesici Uç Uyumluluğu / Insert Suitability	FIYAT
	R	L		PRICE
				EURO
PCLNR 001 ISO	✓	✓	PCLNR 20X20 K12	65,00 €
PCLNR 002 ISO	✓	✓	PCLNR 25X25 M12	68,00 €
PCLNR 003 ISO	✓	✓	PCLNR 32X32 P12	82,67 €
PCLNR 004 ISO	✓	✓	PCLNR 40X40 R12	138,67 €
PCLNR 005 ISO	✓	✓	PCLNR 25X25 M16	79,00 €
PCLNR 006 ISO	✓	✓	PCLNR 32X32 P16	92,67 €
PCLNR 007 ISO	✓	✓	PCLNR 40X40 R16	138,67 €
PCLNR 008 ISO	✓	✓	PCLNR 32X32 P19	92,67 €
PCLNR 009 ISO	✓	✓	PCLNR 40X40 R19	142,00 €

PDJNR ISO



93°

KOD	Stok / Stock		Kesici Uç Uyumluluğu / Insert Suitability	FIYAT
	R	L		PRICE
				EURO
PDJNR 001 ISO	✓	✓	PDJNR 20X20 K15	65,00 €
PDJNR 002 ISO	✓	✓	PDJNR 25X25 M15	68,00 €
PDJNR 003 ISO	✓	✓	PDJNR 32X32 P15	89,67 €
PDJNR 004 ISO	✓	✓	PDJNR 40X40 R15	129,67 €

PDNNN ISO



62,5°

KOD	Stok / Stock		Kesici Uç Uyumluluğu / Insert Suitability	FIYAT
	R	L		PRICE
				EURO
PDNNN 001 ISO	✓	✓	PDNNN 20X20 K15	65,00 €
PDNNN 002 ISO	✓	✓	PDNNN 25X25 M15	68,00 €
PDNNN 003 ISO	✓	✓	PDNNN 32X32 P15	89,67 €
PDNNN 004 ISO	✓	✓	PDNNN 40X40 R15	129,67 €

PWLNR ISO



95°

KOD	Stok / Stock		Kesici Uç Uyumluluğu / Insert Suitability	FIYAT
	R	L		PRICE
			ISO	EURO
PWLNR 001 ISO	✓	✓	PWLNR 20X20 K08	65,00 €
PWLNR 002 ISO	✓	✓	PWLNR 25X25 M08	68,00 €
PWLNR 003 ISO	✓	✓	PWLNR 32X32 P08	80,33 €
PWLNR 004 ISO	✓	✓	PWLNR 40X40 R08	129,67 €

PTJNR ISO



93°

KOD	Stok / Stock		Kesici Uç Uyumluluğu / Insert Suitability	FIYAT
	R	L		PRICE
			ISO	EURO
PTJNR 001 ISO	X	X	PTJNR 20X20 K16	65,00 €
PTJNR 002 ISO	X	X	PTJNR 25X25 M16	68,00 €
PTJNR 003 ISO	X	X	PTJNR 32X32 P16	89,67 €
PTJNR 004 ISO	✓	✓	PTJNR 25X25 M22	74,33 €
PTJNR 005 ISO	✓	✓	PTJNR 32X32 P22	92,67 €
PTJNR 006 ISO	X	X	PTJNR 40X40 R22	142,00 €

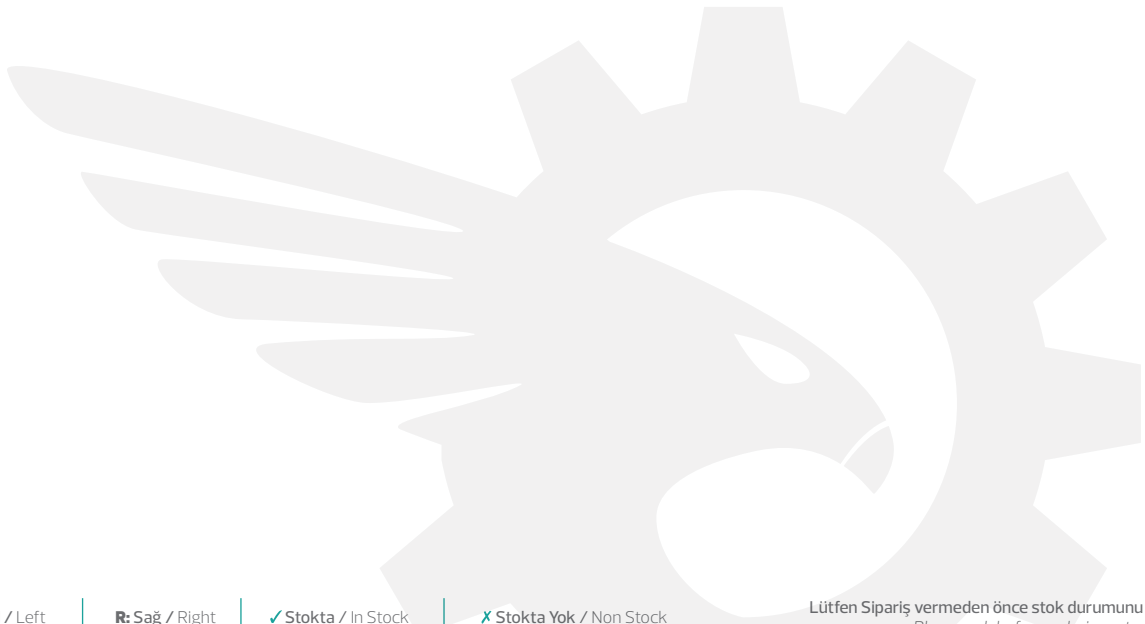



S-SİSTEM İÇ ÇAP TORNALAMA KATERLERİ

S-SYSTEM INTERNAL TURNING TOOLHOLDERS

SVUBR ISO



93°

KOD	Stok / Stock		Kesici Uç Uyumluluğu / Insert Suitability	FIYAT
	R	L		PRICE
				EURO
SVUBR 001 ISO	✓	✓	S16Q SVUBR 11	46,33 €
SVUBR 002 ISO	✓	✓	S20R SVUBR 11	54,33 €
SVUBR 003 ISO	✓	✓	S25S SVUBR 16	55,67 €
SVUBR 004 ISO	✓	✓	S32T SVUBR 16	83,67 €
SVUBR 005 ISO	✓	✓	S40V SVUBR 16	128,33 €

SVUCR ISO



93°

KOD	Stok / Stock		Kesici Uç Uyumluluğu / Insert Suitability	FIYAT
	R	L		PRICE
				EURO
SVUCR 001 ISO	✓	✓	S16Q SVUCR 11	46,33 €
SVUCR 002 ISO	✓	✓	S20R SVUCR 11	54,33 €
SVUCR 003 ISO	✓	✓	S25S SVUCR 16	55,67 €
SVUCR 004 ISO	✓	✓	S32T SVUCR 16	83,67 €
SVUCR 005 ISO	✓	✓	S40V SVUCR 16	128,33 €

SVJBR ISO



93°

KOD	Stok / Stock		Kesici Uç Uyumluluğu / Insert Suitability	FIYAT
	R	L		PRICE
				EURO
SVJBR 001 ISO	✓	✓	S25S SVJBR 16	55,67 €
SVJBR 002 ISO	✓	✓	S32T SVJBR 16	83,67 €
SVJBR 003 ISO	✓	✓	S40V SVJBR 16	128,33 €



KOD	Stok / Stock		Kesici Uç Uyumluluğu / Insert Suitability	FIYAT PRICE
	R	L		EURO
SDPCR 001 ISO	✓	✗	S10K SDPCR 07	31,00 €
SDPCR 002 ISO	✓	✗	S12M SDPCR 07	34,33 €
SDPCR 003 ISO	✓	✗	S16Q SDPCR 11	38,67 €
SDPCR 004 ISO	✓	✓	S20R SDPCR 11	42,00 €
SDPCR 005 ISO	✓	✓	S25S SDPCR 11	49,33 €
SDPCR 006 ISO	✓	✗	S32T SDPCR 11	83,67 €



KOD	Stok / Stock		Kesici Uç Uyumluluğu / Insert Suitability	FIYAT PRICE
	R	L		EURO
SDUCR 001 ISO	✓	✓	S10K SDUCR 07	31,00 €
SDUCR 001 ISO (S)	✓	✓	S10K SDUCR 07 inter cooland	40,00 €
SDUCR 002 ISO	✓	✓	S12M SDUCR 07	34,33 €
SDUCR 002 ISO (S)	✓	✓	S12M SDUCR 07 inter cooland	49,33 €
SDUCR 003 ISO	✓	✓	S16Q SDUCR 07	38,67 €
SDUCR 004 ISO	✓	✓	S16Q SDUCR 11	38,67 €
SDUCR 004 ISO (S)	✓	✓	S16Q SDUCR 11 inter cooland	49,33 €
SDUCR 005 ISO	✓	✓	S20R SDUCR 07	42,00 €
SDUCR 006 ISO	✓	✓	S20R SDUCR 11	42,00 €
SDUCR 006 ISO (S)	✓	✓	S20R SDUCR 11 inter cooland	55,67 €
SDUCR 007 ISO	✓	✓	S25S SDUCR 11	49,33 €
SDUCR 007 ISO (S)	✓	✓	S25R SDUCR 11 inter cooland	63,33 €
SDUCR 008 ISO	✓	✓	S25S SDUCR 07	49,33 €
SDUCR 009 ISO	✓	✓	S32T SDUCR 11	83,67 €
SDUCR 010 ISO	✓	✓	S40V SDUCR 11	128,33 €



KOD	Stok / Stock		Kesici Uç Uyumluluğu / Insert Suitability	FIYAT PRICE
	R	L		EURO
SDQCR 001 ISO	✓	✓	S10K SDQCR 07	31,00 €
SDQCR 001 ISO (S)	✓	✗	S10K SDQCR 07 inter cooland	43,33 €
SDQCR 002 ISO	✓	✓	S12M SDQCR 07	34,33 €
SDQCR 002 ISO (S)	✓	✗	S12M SDQCR 07 inter cooland	46,33 €
SDQCR 003 ISO	✓	✓	S16Q SDQCR 07	38,67 €
SDQCR 004 ISO	✓	✓	S20R SDQCR 07	42,00 €
SDQCR 005 ISO	✓	✓	S16Q SDQCR 11	38,67 €
SDQCR 005 ISO (S)	✓	✗	S16Q SDQCR 11 inter cooland	52,67 €
SDQCR 006 ISO	✓	✓	S20R SDQCR 11	42,00 €
SDQCR 006 ISO (S)	✓	✗	S20R SDQCR 11 inter cooland	55,67 €
SDQCR 007 ISO	✓	✓	S25S SDQCR 07	49,33 €
SDQCR 008 ISO	✓	✓	S25S SDQCR 11	49,33 €
SDQCR 009 ISO	✓	✓	S32T SDQCR 11	83,67 €

SD-CR ISO



62,5°

KOD	Stok / Stock		Kesici Uç Uyumluluğu / Insert Suitability	FIYAT
	R	L		EURO
SD-CR 001 ISO	✓	✓	S10K SD-CR 07	34,33 €
SD-CR 002 ISO	✓	✓	S12M SD-CR 07	34,33 €
SD-CR 003 ISO	✓	✓	S16Q SD-CR 07	38,67 €
SD-CR 004 ISO	✓	✓	S16Q SD-CR 11	38,67 €
SD-CR 005 ISO	✓	✓	S20R SD-CR 11	42,00 €
SD-CR 006 ISO	✓	✓	S25S SD-CR 11	49,33 €
SD-CR 007 ISO	✓	✓	S32T SD-CR 11	83,67 €
SD-CR 008 ISO	✓	✓	S40V SD-CR 11	128,33 €

SDXCR ISO



93°

KOD	Stok / Stock		Kesici Uç Uyumluluğu / Insert Suitability	FIYAT
	R	L		EURO
SDXCR 001 ISO	✓	✓	S12M SDXCR 07	34,33 €
SDXCR 002 ISO	✓	✓	S16Q SDXCR 07	38,67 €
SDXCR 003 ISO	✓	✓	S16Q SDXCR 11	38,67 €
SDXCR 004 ISO	✓	✓	S20R SDXCR 11	42,00 €
SDXCR 005 ISO	✓	✓	S25S SDXCR 11	49,33 €
SDXCR 006 ISO	✓	✓	S32T SDXCR 11	83,67 €
SDXCR 007 ISO	✓	✓	S40V SDXCR 11	128,33 €

SET SDUCR



KOD	Stok / Stock		Kesici Uç Uyumluluğu / Insert Suitability	FIYAT
	R	L		EURO
SET 3 SDUCR ISO	✓	✓	SDUCR 10/12/16	98,00 €
SET 3 SDUCR ISO (S)	✓	✓	SDUCR 10/12/16 inter cooland	204,00 €
SET 4 SDUCR ISO	✓	✓	SDUCR 10/12/16/20	140,00 €
SET 4 SDUCR ISO (S)	✓	✓	SDUCR 10/12/16/20 inter cooland	185,33 €

SET SCLCR



SCLCR ISO



95°

STFCR ISO



90°

KOD	Stok / Stock		Kesici Uç Uyumluluğu / Insert Suitability	FIYAT
	R	L		PRICE
				EURO
SET 4 SCLCR ISO	✓	✓	SCLCR 08/10/12/16	136,00 €
SET 4 SCLCR ISO (S)	✓	✓	SCLCR 08/10/12/16 inter cooland	160,00 €
SET 5 SCLCR ISO	✓	✓	SCLCR 08/10/12/16/20	176,00 €
SET 5 SCLCR ISO (S)	✓	✓	SCLCR 08/10/12/16/20 inter cooland	244,00 €
SET 6 SCLCR ISO	✓	✓	SCLCR 06/08/10/12/16/20	176,00 €
SET 6 SCLCR ISO (S)	✓	✓	SCLCR 06/08/10/12/16/20 inter cooland	244,00 €

KOD	Stok / Stock		Kesici Uç Uyumluluğu / Insert Suitability	FIYAT
	R	L		PRICE
				EURO
SCLCR/S 001 ISO	✓	✓	S06-08H SCLCR 06	31,00 €
SCLCR/S 001 ISO (S)	✓	✓	S06-08H SCLCR 06inter cooland	43,33 €
SCLCR/S 002 ISO	✓	✓	S08H SCLCR 06	31,00 €
SCLCR/S 002 ISO (S)	✓	✓	S08H SCLCR 06 inter cooland	43,33 €
SCLCR/S 003 ISO	✓	✓	S10K SCLCR 06	31,00 €
SCLCR/S 003 ISO (S)	✓	✓	S10K SCLCR 06 inter cooland	43,33 €
SCLCR/S 004 ISO	✓	✓	S12M SCLCR 06	34,33 €
SCLCR/S 004 ISO (S)	✓	✓	S12M SCLCR 06 inter cooland	46,33 €
SCLCR/S 005 ISO	✓	✓	S12M SCLCR 09	36,00 €
SCLCR/S 005 ISO (S)	✓	✓	S12M SCLCR 09 inter cooland	46,33 €
SCLCR/S 006 ISO	✓	✓	S16Q SCLCR 06	38,67 €
SCLCR/S 006 ISO (S)	✓	✓	S16Q SCLCR 06 inter cooland	49,33 €
SCLCR/S 007 ISO	✓	✓	S16Q SCLCR 09	38,67 €
SCLCR/S 007 ISO (S)	✓	✓	S16Q SCLCR 09 inter cooland	49,33 €
SCLCR/S 008 ISO	✓	✓	S20R SCLCR 09	43,33 €
SCLCR/S 008 ISO (S)	✓	✓	S20R SCLCR 09 inter cooland	55,67 €
SCLCR/S 009 ISO	✓	✓	S25S SCLCR 09	54,33 €
SCLCR/S 010 ISO	✓	✓	S32T SCLCR 09	77,33 €
SCLCR/S 011 ISO	✓	✓	S25S SCLCR 12	54,33 €
SCLCR/S 011 ISO (S)	✓	✓	S25S SCLCR 12 inter cooland	61,67 €
SCLCR/S 012 ISO	✓	✓	S32T SCLCR 12	77,33 €
SCLCR/S 013 ISO	✓	✓	S40V SCLCR 12	128,33 €
SCLCR/S 018 ISO	✓	✓	S10-12K SCLCR 06	35,67 €
SCLCR/S 019 ISO	✓	✗	S12-16M SCLCR 06	38,00 €
SCLCR/S 020 ISO	✓	✗	S12-16M SCLCR 09	38,00 €

KOD	Stok / Stock		Kesici Uç Uyumluluğu / Insert Suitability	FIYAT
	R	L		PRICE
				EURO
STFCR/S 001 ISO	✓	✓	S16Q STFCR 16	38,67 €
STFCR/S 002 ISO	✓	✓	S20R STFCR 16	42,00 €
STFCR/S 003 ISO	✓	✓	S25S STFCR 16	49,33 €
STFCR/S 004 ISO	✓	✓	S32T STFCR 16	83,67 €
STFCR/S 005 ISO	✓	✓	S12M STFCR 11	37,33 €



C-SİSTEM İÇ ÇAP TORNALAMA KATERLERİ

C-SYSTEM INTERNAL TURNING TOOLHOLDERS

C-SİSTEM İÇ ÇAP TORNALAMA KATERLERİ

C-SYSTEM INTERNAL TURNING TOOLHOLDERS

MBC
Cutting Tools

CKUNR ISO



93°

KOD	Stok / Stock		Kesici Uç Uyumluluğu / Insert Suitability	FİYAT PRICE EURO
	R	L		
CKUNR 002 ISO	✓	✓	S25S CKUNR 16	57,33 €
CKUNR 003 ISO	✓	✓	S32T CKUNR 16	75,67 €
CKUNR 004 ISO	✓	✓	S40V CKUNR 16	135,33 €
CKUNR 005 ISO	✓	✓	S50W CKUNR 16	179,00 €
CKUNR 006 ISO	✓	X	S60W CKUNR 16	251,00 €

CTUPR ISO



93°

KOD	Stok / Stock		Kesici Uç Uyumluluğu / Insert Suitability	FİYAT PRICE EURO
	R	L		
CTUPR 001 ISO	✓	X	S16Q CTUPR 16	54,33 €
CTUPR 002 ISO	✓	X	S20R CTUPR 16	54,33 €
CTUPR 003 ISO	✓	X	S25S CTUPR 16	55,67 €

T-SİSTEM İÇ ÇAP TORNALAMA KATERLERİ

T-SYSTEM INTERNAL TURNING TOOLHOLDERS

TDUNR ISO



93°

KOD	Stok / Stock		Kesici Uç Uyumluluğu / Insert Suitability	FİYAT PRICE EURO
	R	L		
TDUNR 001 ISO	✓	✓	S20R TDUNR 11	71,00 €
TDUNR 002 ISO	✓	✓	S25S TDUNR 15	75,67 €
TDUNR 003 ISO	✓	✓	S32T TDUNR 15	92,67 €
TDUNR 004 ISO	✓	✓	S40V TDUNR 15	144,00 €
TDUNR 005 ISO	✓	✓	S50W TDUNR 15	182,67 €
TDUNR 006 ISO	✓	✓	S60W TDUNR 15	251,00 €

Lütfen Sipariş vermeden önce stok durumunu sorunuz.
Please ask before ordering, stock status.

L: Sol / Left

R: Sağ / Right

✓ Stokta / In Stock

X Stokta Yok / Non Stock

TDQNR ISO



107,5°

TD-NR ISO



62,5°

TCLNR ISO



95°

TWLNR ISO



95°

KOD	Stok / Stock		Kesici Uç Uyumluluğu / Insert Suitability	FİYAT PRICE
	R	L		ISO
TDQNR 000 ISO	✓	✓	S25S TDQNR 15	75,67 €
TDQNR 001 ISO	✓	✓	S32T TDQNR 15	92,67 €
TDQNR 002 ISO	✓	✓	S40V TDQNR 15	144,00 €
TDQNR 003 ISO	✓	✓	S50W TDQNR 15	182,67 €

KOD	Stok / Stock		Kesici Uç Uyumluluğu / Insert Suitability	FİYAT PRICE
	R	L		ISO
TD-NR 001 ISO	✓	✓	S32T TD-NR 15	92,67 €
TD-NR 002 ISO	✓	✓	S40V TD-NR 15	144,00 €
TD-NR 003 ISO	✓	X	S50W TD-NR 15	182,67 €

KOD	Stok / Stock		Kesici Uç Uyumluluğu / Insert Suitability	FİYAT PRICE
	R	L		ISO
TCLNR/S 001 ISO	✓	✓	S25S TCLNR 12	75,67 €
TCLNR/S 002 ISO	✓	✓	S32T TCLNR 12	92,67 €
TCLNR/S 003 ISO	✓	✓	S40V TCLNR 16	144,00 €
TCLNR/S 004 ISO	✓	✓	S50W TCLNR 16	182,67 €
TCLNR/S 005 ISO	✓	✓	S32T TCLNR 16	108,33 €
TCLNR/S 006 ISO	✓	✓	S40V TCLNR 12	156,33 €
TCLNR/S 007 ISO	✓	X	S60W TCLNR 16	251,00 €
TCLNR/S 008 ISO	✓	✓	S40V TCLNR 19	156,33 €
TCLNR/S 009 ISO	✓	X	S50W TCLNR 19	219,33 €

KOD	Stok / Stock		Kesici Uç Uyumluluğu / Insert Suitability	FİYAT PRICE
	R	L		ISO
TWLNR/S 002 ISO	✓	✓	S20R TWLNR 06	71,00 €
TWLNR/S 002 ISO (S)	✓	✓	S20R TWLNR 06 inter cooland	85,00 €
TWLNR/S 003 ISO	✓	✓	S25S TWLNR 08	75,67 €
TWLNR/S 003 ISO (S)	✓	✓	S25S TWLNR 08 inter cooland	89,67 €
TWLNR/S 004 ISO	✓	✓	S32T TWLNR 08	92,67 €
TWLNR/S 005 ISO	✓	✓	S40V TWLNR 08	144,00 €
TWLNR/S 006 ISO	✓	✓	S50W TWLNR 08	182,67 €
TWLNR/S 007 ISO	✓	✓	S60W TWLNR 08	251,00 €

T-SİSTEM İÇ ÇAP TORNALAMA KATERLERİ

T-SYSTEM INTERNAL TURNING TOOLHOLDERS

MTUNR ISO



93°

MT-NR ISO



60°

KOD	Stok / Stock		Kesici Uç Uyumluluğu / Insert Suitability	FİYAT PRICE EURO
	R	L		
MTUNR 001 ISO	✓	✓	S20R MTUNR 16	72,67 €
MTUNR 002 ISO	✓	✓	S25S MTUNR 16	80,33 €
MTUNR 003 ISO	✓	✓	S32T MTUNR 16	105,33 €
MTUNR 004 ISO	✓	✓	S40V MTUNR 16	128,33 €
MTUNR 005 ISO	✓	✓	S32T MTUNR 22	105,33 €
MTUNR 006 ISO	✓	✓	S40V MTUNR 22	128,33 €
MTUNR 007 ISO	✓	✓	S50W MTUNR 22	182,67 €
MTUNR 008 ISO	✓	✗	S60W MTUNR 22	222,33 €

KOD	Stok / Stock		Kesici Uç Uyumluluğu / Insert Suitability	FİYAT PRICE EURO
	R	L		
MT-NR 001 ISO	✓	✓	S20R MT-NR 16	72,67 €
MT-NR 002 ISO	✓	✓	S25S MT-NR 16	80,33 €
MT-NR 003 ISO	✓	✓	S32T MT-NR 16	105,33 €
MT-NR 004 ISO	✓	✓	S40V MT-NR 16	144,00 €
MT-NR 005 ISO	✓	✗	S50W MT-NR 16	182,67 €
MT-NR 006 ISO	✓	✗	S32T MT-NR 22	105,33 €
MT-NR 007 ISO	✓	✗	S40V MT-NR 22	144,00 €

M-SİSTEM İÇ ÇAP TORNALAMA KATERLERİ

M-SYSTEM INTERNAL TURNING TOOLHOLDERS

MTQNR ISO



107,5°

KOD	Stok / Stock		Kesici Uç Uyumluluğu / Insert Suitability	FİYAT PRICE EURO
	R	L		
MTQNR 001 ISO	✓	✓	S20R MTQNR 16	72,67 €
MTQNR 002 ISO	✓	✓	S25S MTQNR 16	80,33 €
MTQNR 003 ISO	✓	✓	S32T MTQNR 16	105,33 €
MTQNR 004 ISO	✓	✓	S40V MTQNR 16	144,00 €
MTQNR 005 ISO	✓	✓	S32T MTQNR 22	105,33 €
MTQNR 006 ISO	✓	✓	S40V MTQNR 22	144,00 €

MWLNR ISO



KOD	Stok / Stock		Kesici Uç Uyumluluğu / Insert Suitability	FİYAT PRICE EURO
	R	L		
MWLNR/S 001 ISO	✓	✓	S16Q MWLNR 06	65,00 €
MWLNR/S 002 ISO	✓	✓	S20R MWLNR 06	71,00 €
MWLNR/S 003 ISO	✓	✓	S25S MWLNR 08	80,33 €
MWLNR/S 004 ISO	✓	✓	S32T MWLNR 08	105,33 €
MWLNR/S 005 ISO	✓	✓	S40V MWLNR 08	144,00 €
MWLNR/S 006 ISO	✓	✓	S50W MWLNR 08	182,67 €
MWLNR/S 007 ISO	✗	✗	S60W MWLNR 08	251,00 €

P-SİSTEM İÇ ÇAP TORNALAMA KATERLERİ
P-SYSTEM INTERNAL TURNING TOOLHOLDERS

PCLNR ISO



KOD	Stok / Stock		Kesici Uç Uyumluluğu / Insert Suitability	FİYAT PRICE EURO
	R	L		
PCLNR/S 001 ISO	✓	✗	S25S PCLNR 12	75,67 €
PCLNR/S 002 ISO	✓	✗	S32T PCLNR 12	98,33 €
PCLNR/S 003 ISO	✓	✓	S40V PCLNR 12	144,00 €
PCLNR/S 004 ISO	✓	✗	S32T PCLNR 16	98,33 €
PCLNR/S 005 ISO	✓	✗	S40V PCLNR 16	147,67 €
PCLNR/S 007 ISO	✓	✗	S40V PCLNR 19	154,33 €
PCLNR/S 008 ISO	✗	✗	S50V PCLNR 19	186,00 €

PDUNR ISO



KOD	Stok / Stock		Kesici Uç Uyumluluğu / Insert Suitability	FİYAT PRICE EURO
	R	L		
PDUNR/S 001 ISO	✓	✗	S25S PDUNR 15	75,67 €
PDUNR/S 002 ISO	✓	✗	S32T PDUNR 15	98,33 €
PDUNR/S 003 ISO	✓	✗	S40V PDUNR 15	144,00 €

PWLNR ISO



95°

KOD	Stok / Stock		Kesici Uç Uyumluluğu / Insert Suitability	FIYAT
	R	L		PRICE
			ISO	EURO
PWLNR/S 001 ISO	✓	✗	S25S PWLNR 08	75,67 €
PWLNR/S 002 ISO	✓	✗	S32T PWLNR 08	98,33 €
PWLNR/S 003 ISO	✓	✗	S40V PWLNR 08	144,00 €

PTUNR ISO



93°

KOD	Stok / Stock		Kesici Uç Uyumluluğu / Insert Suitability	FIYAT
	R	L		PRICE
			ISO	EURO
PTUNR/S 001 ISO	✗	✗	S20R PTUNR 16	71,00 €
PTUNR/S 002 ISO	✗	✗	S25S PTUNR 16	75,67 €
PTUNR/S 003 ISO	✗	✗	S32T PTUNR 16	98,33 €
PTUNR/S 005 ISO	✓	✗	S32T PTUNR 22	101,00 €
PTUNR/S 006 ISO	✓	✗	S40V PTUNR 22	147,67 €



ŞAFTLI TARAMALAR END MILLS

APKT 1003 ISO



KOD	Stok / Stock	Kesici Uç Uyumluluğu / Insert Suitability		FİYAT PRICE
		ISO AP..1003		EURO
ST AP..10 001 ISO	✓	EM90 D12 W12 L120 Z01 AP.1003		58,67 €
ST AP..10 001 ISO (S)	✓	EM90 D12 W12 L120 Z01 AP.1003 inter cooland		68,00 €
ST AP..10 002 ISO	✓	EM90 D14 W12 L120 Z01 AP.1003		61,67 €
ST AP..10 003 ISO	✓	EM90 D16 W16 L100 Z02 AP.1003		61,67 €
ST AP..10 003 ISO (S)	✓	EM90 D16 W16 L100 Z02 AP.1003 inter cooland		77,33 €
ST AP..10 004 ISO	✓	EM90 D16 W16 L120 Z02 AP.1003		71,00 €
ST AP..10 004 ISO (S)	✓	EM90 D16 W16 L120 Z02 AP.1003 inter cooland		80,33 €
ST AP..10 005 ISO	✓	EM90 D16 W16 L150 Z02 AP.1003		80,33 €
ST AP..10 005 ISO (S)	✓	EM90 D16 W16 L150 Z02 AP.1003 inter cooland		89,67 €
ST AP..10 006 ISO	✓	EM90 D16 W16 L200 Z02 AP.1003		96,00 €
ST AP..10 006 ISO (S)	✓	EM90 D16 W16 L200 Z02 AP.1003 inter cooland		105,33 €
ST AP..10 007 ISO	✓	EM90 D16 W16 L250 Z02 AP.1003		102,00 €
ST AP..10 008 ISO	✓	EM90 D18 W16 L100 Z02 AP.1003		61,67 €
ST AP..10 008 ISO (S)	✓	EM90 D18 W16 L100 Z02 AP.1003 inter cooland		71,00 €
ST AP..10 009 ISO	✓	EM90 D18 W16 L120 Z02 AP.1003		68,00 €
ST AP..10 009 ISO (S)	✓	EM90 D18 W16 L120 Z02 AP.1003 inter cooland		77,33 €
ST AP..10 010 ISO	✓	EM90 D18 W16 L150 Z02 AP.1003		89,67 €
ST AP..10 010 ISO (S)	✓	EM90 D18 W16 L150 Z02 AP.1003 inter cooland		99,00 €
ST AP..10 011 ISO	✓	EM90 D18 W16 L200 Z02 AP.1003		102,00 €
ST AP..10 011 ISO (S)	✓	EM90 D18 W16 L200 Z02 AP.1003 inter cooland		111,33 €
ST AP..10 012 ISO	✓	EM90 D20 W20 L100 Z03 AP.1003		71,00 €
ST AP..10 012 ISO (S)	✓	EM90 D20 W20 L100 Z03 AP.1003 inter cooland		83,67 €
ST AP..10 013 ISO	✓	EM90 D20 W20 L120 Z03 AP.1003		77,33 €
ST AP..10 013 ISO (S)	✓	EM90 D20 W20 L120 Z03 AP.1003 inter cooland		89,67 €
ST AP..10 014 ISO	✓	EM90 D18 W16 L250 Z02 AP.1003		108,33 €
ST AP..10 015 ISO	✓	EM90 D20 W20 L150 Z03 AP.1003		99,00 €
ST AP..10 015 ISO (S)	✓	EM90 D20 W20 L150 Z03 AP.1003 inter cooland		108,33 €
ST AP..10 016 ISO	✓	EM90 D20 W20 L200 Z03 AP.1003		117,67 €
ST AP..10 016 ISO (S)	✓	EM90 D20 W20 L200 Z03 AP.1003 inter cooland		139,00 €
ST AP..10 017 ISO	✓	EM90 D20 W20 L250 Z03 AP.1003		129,67 €
ST AP..10 018 ISO	✓	EM90 D22 W20 L100 Z03 AP.1003		74,33 €
ST AP..10 018 ISO (S)	✓	EM90 D22 W20 L100 Z03 AP.1003 inter cooland		89,67 €
ST AP..10 019 ISO	✓	EM90 D22 W20 L120 Z03 AP.1003		77,33 €
ST AP..10 019 ISO (S)	✓	EM90 D22 W20 L120 Z03 AP.1003 inter cooland		89,67 €
ST AP..10 020 ISO	✓	EM90 D22 W20 L150 Z03 AP.1003		99,00 €
ST AP..10 020 ISO (S)	✓	EM90 D22 W20 L150 Z03 AP.1003 inter cooland		108,33 €
ST AP..10 021 ISO	✓	EM90 D22 W20 L200 Z03 AP.1003		123,33 €
ST AP..10 022 ISO	✓	EM90 D22 W20 L250 Z03 AP.1003		139,00 €
ST AP..10 023 ISO	✓	EM90 D25 W25 L100 Z03 AP.1003		83,67 €
ST AP..10 023 ISO (S)	✓	EM90 D25 W25 L100 Z03 AP.1003 inter cooland		99,00 €
ST AP..10 024 ISO	✓	EM90 D25 W25 L120 Z03 AP.1003		89,67 €
ST AP..10 024 ISO (S)	✓	EM90 D25 W25 L120 Z03 AP.1003 inter cooland		102,00 €
ST AP..10 025 ISO	✓	EM90 D25 W25 L150 Z03 AP.1003		108,33 €
ST AP..10 025 ISO (S)	✓	EM90 D25 W25 L150 Z03 AP.1003 inter cooland		120,67 €
ST AP..10 026 ISO	✓	EM90 D25 W25 L200 Z03 AP.1003		129,67 €
ST AP..10 026 ISO (S)	✓	EM90 D25 W25 L200 Z03 AP.1003 inter cooland		142,00 €
ST AP..10 027 ISO	✓	EM90 D25 W25 L250 Z03 AP.1003		142,00 €
ST AP..10 028 ISO	✓	EM90 D28 W25 L150 Z04 AP.1003		108,33 €
ST AP..10 029 ISO	✓	EM90 D26 W25 L150 Z03 AP.1003		108,33 €
ST AP..10 030 ISO	✓	EM90 D26 W25 L200 Z03 AP.1003		129,67 €
ST AP..10 031 ISO	✓	EM90 D26 W25 L250 Z03 AP.1003		142,00 €
ST AP..10 032 ISO	✓	EM90 D30 W25 L100 Z04 AP.1003		89,67 €
ST AP..10 032 ISO (S)	✓	EM90 D30 W25 L100 Z04 AP.1003 inter cooland		102,00 €
ST AP..10 033 ISO	✓	EM90 D30 W25 L120 Z04 AP.1003		102,00 €
ST AP..10 033 ISO (S)	✓	EM90 D30 W25 L120 Z04 AP.1003 inter cooland		114,33 €
ST AP..10 034 ISO	✓	EM90 D30 W25 L150 Z03 AP.1003		114,33 €
ST AP..10 035 ISO	✓	EM90 D30 W25 L150 Z04 AP.1003		114,33 €
ST AP..10 035 ISO (S)	✓	EM90 D30 W25 L150 Z04 AP.1003 inter cooland		123,33 €

APKT 1003 ISO



KOD	Stok / Stock	Kesici Uç Uyumluluğu / Insert Suitability	FIYAT PRICE
		ISO AP..1003	EURO
ST AP..10 036 ISO	✓	EM90 D30 W25 L200 Z04 AP.1003	139,00 €
ST AP..10 036 ISO (S)	✓	EM90 D30 W25 L200 Z04 AP.1003 inter cooland	151,33 €
ST AP..10 038 ISO	✓	EM90 D32 W25 L150 Z04 AP.1003	114,33 €
ST AP..10 039 ISO	✓	EM90 D32 W32 L150 Z04 AP.1003	120,67 €
ST AP..10 040 ISO	✓	EM90 D32 W32 L200 Z04 AP.1003	129,67 €
ST AP..10 040 ISO (S)	✓	EM90 D32 W32 L200 Z04 AP.1003 inter cooland	139,00 €
ST AP..10 041 ISO	✓	EM90 D35 W25 L100 Z04 AP.1003	99,00 €
ST AP..10 041 (S) ISO	✓	EM90 D35 W25 L100 Z04 AP.1003 inter cooland	108,33 €
ST AP..10 042 ISO	✓	EM90 D35 W25 L120 Z04 AP.1003	111,33 €
ST AP..10 043 ISO	✓	EM90 D35 W25 L150 Z04 AP.1003	105,33 €
ST AP..10 043 (S) ISO	✓	EM90 D35 W25 L150 Z04 AP.1003 inter cooland	120,67 €
ST AP..10 044 ISO	✓	EM90 D35 W25 L200 Z04 AP.1003	139,00 €
ST AP..10 045 ISO	✓	EM90 D35 W32 L100 Z04 AP.1003	105,33 €
ST AP..10 046 ISO	✓	EM90 D35 W32 L120 Z04 AP.1003	111,33 €
ST AP..10 047 ISO	✓	EM90 D35 W32 L150 Z04 AP.1003	120,67 €
ST AP..10 048 ISO	✓	EM90 D40 W25 L100 Z05 AP.1003	105,33 €
ST AP..10 048 ISO (S)	✓	EM90 D40 W25 L100 Z05 AP.1003 inter cooland	117,67 €
ST AP..10 049 ISO	✓	EM90 D40 W25 L120 Z05 AP.1003	108,33 €
ST AP..10 049 ISO (S)	✓	EM90 D40 W25 L120 Z05 AP.1003 inter cooland	120,67 €
ST AP..10 050 ISO	✓	EM90 D40 W25 L150 Z05 AP.1003	117,67 €
ST AP..10 050 ISO (S)	✓	EM90 D40 W25 L150 Z05 AP.1003 inter cooland	123,33 €
ST AP..10 051 ISO	✓	EM90 D40 W25 L200 Z05 AP.1003	154,33 €
ST AP..10 051 ISO (S)	✓	EM90 D40 W25 L200 Z05 AP.1003 inter cooland	166,67 €
ST AP..10 053 ISO	✓	EM90 D40 W32 L100 Z05 AP.1003	105,33 €
ST AP..10 053 ISO (S)	✓	EM90 D40 W32 L100 Z05 AP.1003 inter cooland	114,33 €
ST AP..10 054 ISO	✓	EM90 D40 W32 L120 Z05 AP.1003	108,33 €
ST AP..10 054 ISO (S)	✓	EM90 D40 W32 L120 Z05 AP.1003 inter cooland	117,67 €
ST AP..10 055 ISO	✓	EM90 D40 W32 L150 Z05 AP.1003	120,67 €
ST AP..10 055 ISO (S)	✓	EM90 D40 W32 L150 Z05 AP.1003 inter cooland	129,67 €
ST AP..10 056 ISO	✓	EM90 D17 W16 L150 Z02 AP.1003	89,67 €
ST AP..10 057 ISO	✓	EM90 D21 W20 L150 Z03 AP.1003	99,00 €
ST AP..10 058 ISO	✓	EM90 D21 W20 L200 Z03 AP.1003	123,33 €

APKT 1604 ISO



KOD	Stok / Stock	Kesici Uç Uyumluluğu / Insert Suitability	FIYAT PRICE
		ISO AP..1604..	EURO
ST AP..16 001 ISO	✓	EM90 D25 W25 L100 Z02 AP..1604	71,00 €
ST AP..16 001 ISO (S)	✓	EM90 D25 W25 L100 Z02 AP..1604 inter cooland	86,67 €
ST AP..16 002 ISO	✓	EM90 D25 W25 L120 Z02 AP..1604	77,33 €
ST AP..16 002 ISO (S)	✓	EM90 D25 W25 L120 Z02 AP..1604 inter cooland	89,67 €
ST AP..16 003 ISO	✓	EM90 D25 W25 L150 Z02 AP..1604	102,00 €
ST AP..16 003 ISO (S)	✓	EM90 D25 W25 L150 Z02 AP..1604 inter cooland	114,33 €
ST AP..16 004 ISO	✓	EM90 D25 W25 L200 Z02 AP..1604	117,67 €
ST AP..16 004 ISO (S)	✓	EM90 D25 W25 L200 Z02 AP..1604 inter cooland	129,67 €
ST AP..16 005 ISO	✓	EM90 D25 W25 L250 Z02 AP..1604	151,33 €
ST AP..16 006 ISO	✓	EM90 D25 W25 L300 Z02 AP..1604	173,00 €
ST AP..16 007 ISO	✓	EM90 D30 W25 L100 Z03 AP..1604	77,33 €
ST AP..16 007 ISO (S)	✓	EM90 D30 W25 L100 Z03 AP..1604 inter cooland	89,67 €
ST AP..16 008 ISO	✓	EM90 D30 W25 L120 Z03 AP..1604	80,33 €
ST AP..16 008 ISO (S)	✓	EM90 D30 W25 L120 Z03 AP..1604 inter cooland	92,67 €
ST AP..16 009 ISO	✓	EM90 D30 W25 L150 Z03 AP..1604	105,33 €
ST AP..16 009 ISO (S)	✓	EM90 D30 W25 L150 Z03 AP..1604 inter cooland	117,67 €
ST AP..16 010 ISO	✓	EM90 D30 W25 L200 Z03 AP..1604	129,67 €
ST AP..16 010 ISO (S)	✓	EM90 D30 W25 L200 Z03 AP..1604 inter cooland	142,00 €
ST AP..16 011 ISO	✓	EM90 D30 W25 L250 Z03 AP..1604	160,67 €
ST AP..16 012 ISO	✓	EM90 D30 W25 L300 Z03 AP..1604	173,00 €
ST AP..16 013 ISO	✓	EM90 D32 W25 L100 Z03 AP..1604	77,33 €
ST AP..16 013 ISO (S)	✓	EM90 D32 W25 L100 Z03 AP..1604 inter cooland	89,67 €
ST AP..16 014 ISO	✓	EM90 D32 W25 L120 Z03 AP..1604	83,67 €
ST AP..16 014 ISO (S)	✓	EM90 D32 W25 L120 Z03 AP..1604 inter cooland	96,00 €
ST AP..16 015 ISO	✓	EM90 D32 W25 L150 Z03 AP..1604	108,33 €
ST AP..16 015 ISO (S)	✓	EM90 D32 W25 L150 Z03 AP..1604 inter cooland	120,67 €
ST AP..16 016 ISO	✓	EM90 D32 W25 L200 Z03 AP..1604	129,67 €
ST AP..16 016 ISO (S)	✓	EM90 D32 W25 L200 Z03 AP..1604 inter cooland	142,00 €
ST AP..16 017 ISO	✓	EM90 D32 W32 L100 Z03 AP..1604	80,34 €
ST AP..16 017 (S) ISO	✓	EM90 D32 W32 L100 Z03 AP..1604 inter cooland	92,67 €
ST AP..16 018 ISO	✓	EM90 D32 W32 L120 Z03 AP..1604	86,67 €
ST AP..16 018 ISO (S)	✓	EM90 D32 W32 L120 Z03 AP..1604 inter cooland	99,00 €
ST AP..16 019 ISO	✓	EM90 D32 W32 L150 Z03 AP..1604	108,33 €
ST AP..16 019 ISO (S)	✓	EM90 D32 W32 L150 Z03 AP..1604 inter cooland	120,67 €
ST AP..16 020 ISO	✓	EM90 D32 W32 L200 Z03 AP..1604	129,67 €
ST AP..16 020 ISO (S)	✓	EM90 D32 W32 L200 Z03 AP..1604 inter cooland	145,33 €
ST AP..16 021 ISO	✓	EM90 D32 W32 L250 Z03 AP..1604	166,67 €
ST AP..16 022 ISO	✓	EM90 D32 W32 L300 Z03 AP..1604	173,00 €
ST AP..16 023 ISO	✓	EM90 D32 W32 L350 Z03 AP..1604	194,67 €
ST AP..16 024 ISO	✓	EM90 D35 W25 L100 Z03 AP..1604	83,67 €
ST AP..16 025 ISO	✓	EM90 D35 W25 L120 Z03 AP..1604	89,67 €
ST AP..16 026 ISO	✓	EM90 D35 W25 L150 Z03 AP..1604	108,33 €
ST AP..16 027 ISO	✓	EM90 D35 W32 L100 Z03 AP..1604	86,67 €
ST AP..16 028 ISO	✓	EM90 D35 W32 L120 Z03 AP..1604	89,67 €
ST AP..16 029 ISO	✓	EM90 D35 W32 L150 Z03 AP..1604	108,33 €
ST AP..16 029 ISO (S)	✓	EM90 D35 W32 L150 Z03 AP..1604 inter cooland	120,67 €
ST AP..16 031 ISO	✓	EM90 D35 W32 L250 Z03 AP..1604	160,67 €
ST AP..16 032 ISO	✓	EM90 D35 W32 L300 Z03 AP..1604	173,00 €
ST AP..16 033 ISO	✓	EM90 D35 W32 L350 Z03 AP..1604	191,67 €
ST AP..16 034 ISO	✓	EM90 D40 W25 L100 Z04 AP..1604	89,67 €
ST AP..16 034 ISO (S)	✓	EM90 D40 W25 L100 Z04 AP..1604 inter cooland	102,00 €

APKT 1604 ISO



KOD	Stok / Stock	Kesici Uç Uyumluluğu / Insert Suitability		FIYAT PRICE
		ISO AP..1604..		EURO
ST AP..16 035 ISO	✓	EM90 D40 W25 L120 Z04 AP.1604		99,00 €
ST AP..16 035 ISO (S)	✓	EM90 D40 W25 L120 Z04 AP.1604 inter cooland		108,33 €
ST AP..16 036 ISO	✓	EM90 D40 W25 L150 Z04 AP.1604		120,67 €
ST AP..16 036 ISO (S)	✓	EM90 D40 W25 L150 Z04 AP.1604 inter cooland		132,67 €
ST AP..16 037 ISO	✓	EM90 D40 W25 L200 Z04 AP.1604		151,33 €
ST AP..16 037 ISO (S)	✓	EM90 D40 W25 L200 Z04 AP.1604 inter cooland		163,67 €
ST AP..16 038 ISO	✓	EM90 D40 W32 L100 Z04 AP.1604		92,67 €
ST AP..16 038 ISO (S)	✓	EM90 D40 W32 L100 Z04 AP.1604 inter cooland		105,33 €
ST AP..16 039 ISO	✓	EM90 D40 W32 L120 Z04 AP.1604		99,00 €
ST AP..16 039 ISO (S)	✓	EM90 D40 W32 L120 Z04 AP.1604 inter cooland		111,33 €
ST AP..16 040 ISO	✓	EM90 D40 W32 L150 Z04 AP.1604		117,67 €
ST AP..16 040 ISO (S)	✓	EM90 D40 W32 L150 Z04 AP.1604 inter cooland		129,67 €
ST AP..16 041 ISO	✓	EM90 D40 W32 L200 Z04 AP.1604		154,33 €
ST AP..16 041 ISO (S)	✓	EM90 D40 W32 L200 Z04 AP.1604 inter cooland		166,67 €
ST AP..16 042 ISO	✓	EM90 D40 W32 L250 Z04 AP.1604		170,00 €
ST AP..16 043 ISO	✓	EM90 D40 W32 L300 Z04 AP.1604		182,34 €
ST AP..16 044 ISO	✓	EM90 D40 W32 L350 Z04 AP.1604		194,67 €
ST AP..16 045 ISO	✓	EM90 D23,5 W25 L150 Z02 AP.1604		102,00 €
ST AP..16 046 ISO	✓	EM90 D24 W25 L150 Z02 AP.1604		102,00 €
ST AP..16 047 ISO	✓	EM90 D32 W25 L250 Z03 AP.1604		160,67 €

TPKN 1603 ISO



KOD	Stok Stock	Inter Cooland	Kesici Uç Uyumluluğu / Insert Suitability		FIYAT PRICE
			ISO TPKN 1603		EURO
ST TPKN 16 001 ISO	✓	×	EM90 D35 W25 L100 Z02 TPKN 1603		80,33 €
ST TPKN 16 002 ISO	✓	×	EM90 D40 W25 L100 Z03 TPKN 1603		83,67 €
ST TPKN 16 003 ISO	✓	×	EM90 D50 W25 L100 Z03 TPKN 1603		92,67 €

VCGT 2205/1604 ISO



KOD	Stok Stock	Inter Cooland	Kesici Uç Uyumluluğu / Insert Suitability		FIYAT PRICE
			ISO VCGT 2205/1604		EURO
ST VCGT 22 001 ISO	✓	×	EM90 D32 W32 L250 Z02 VCGT 2205		129,67 €

QXMT 17 ISO



KOD	Stok Stock	Inter Cooland	Kesici Uç Uyumluluğu / Insert Suitability	FİYAT PRICE
			ISO QXMT 17	EURO
ST QXMT 17 001 ISO	X	X	EM90 D25 W25 L150 Z02 QXMT 17	102,00 €
ST QXMT 17 003 ISO	✓	X	EM90 D28 W25 L160 Z02 QXMT 17	105,33 €
ST QXMT 17 004 ISO	X	X	EM90 D35 W25 L150 Z03 QXMT 17	114,33 €

APMT 1135 SNG



KOD	Stok Stock	Inter Cooland	Kesici Uç Uyumluluğu / Insert Suitability	FİYAT PRICE
			SNG APMT 1135	EURO
ST APMT 11 001 SNG	✓	✓	EM90 D16 W15 L160 Z02 APMT 1135	92,67 €
ST APMT 11 002 SNG	✓	✓	EM90 D16 W16 L160 Z02 APMT 1135	92,67 €
ST APMT 11 003 SNG	✓	✓	EM90 D16 W16 L200 Z02 APMT 1135	102,00 €
ST APMT 11 004 SNG	✓	✓	EM90 D17 W16 L160 Z02 APMT 1135	99,00 €
ST APMT 11 005 SNG	✓	✓	EM90 D17 W16 L200 Z02 APMT 1135	102,00 €
ST APMT 11 006 SNG	✓	✓	EM90 D20 W20 L160 Z03 APMT 1135	102,00 €
ST APMT 11 007 SNG	✓	✓	EM90 D20 W20 L200 Z03 APMT 1135	114,33 €
ST APMT 11 008 SNG	✓	✓	EM90 D21 W20 L160 Z03 APMT 1135	108,33 €
ST APMT 11 009 SNG	✓	✓	EM90 D21 W20 L200 Z03 APMT 1135	120,67 €
ST APMT 11 010 SNG	✓	✓	EM90 D25 W25 L160 Z03 APMT 1135	108,33 €
ST APMT 11 011 SNG	✓	✓	EM90 D25 W25 L200 Z03 APMT 1135	123,33 €
ST APMT 11 012 SNG	✓	✓	EM90 D26 W25 L160 Z03 APMT 1135	108,33 €
ST APMT 11 013 SNG	✓	✓	EM90 D32 W32 L160 Z04 APMT 1135	120,67 €
ST APMT 11 014 SNG	✓	✓	EM90 D33 W32 L160 Z04 APMT 1135	123,33 €
ST APMT 11 016 SNG	✓	✓	EM90 D26 W25 L200 Z03 APMT 1135	123,33 €

APMT 1035 SNG



KOD	Stok Stock	Inter Cooland	Kesici Uç Uyumluluğu / Insert Suitability	FİYAT PRICE
			SNG APMT 1035	EURO
ST APMT 10 002 SNG	X	✓	EM90 D20 W20 L100 Z03 APMT 1035 inter cooland	89,67 €
ST APMT 10 003 SNG	X	✓	EM90 D25 W25 L100 Z04 APMT 1035 inter cooland	95,67 €

LNGX 1104 SNG



KOD	Stok Stock	Inter Cooland	Kesici Uç Uyumluluğu / Insert Suitability	FİYAT PRICE
			SNG LNGX 1104	EURO
ST LNGX 11 002 SNG	✓	✓	EM90 D20 W20 L160 Z02 LNGX 1104	108,33 €
ST LNGX 11 003 SNG	✓	✓	EM90 D25 W25 L160 Z03 LNGX 1104	120,67 €

ADKX 1204 FTTE



KOD	Stok Stock	Inter Cooland	Kesici Uç Uyumluluğu / Insert Suitability	FİYAT PRICE
			FTTE ADKX 1204	EURO
ST ADKX 12 001 FTTE	✓	✗	EM90 D12 W12 L80 Z01 ADKX 1204	80,33 €
ST ADKX 12 003 FTTE	✗	✗	EM90 D16 W16 L140 Z02 ADKX 1204	89,67 €
ST ADKX 12 007 FTTE	✓	✗	EM90 D25 W25 L100 Z02 ADKX 1204	99,00 €
ST ADKX 12 008 FTTE	✓	✗	EM90 D25 W25 L171 Z02 ADKX 1204	117,67 €
ST ADKX 12 010 FTTE	✗	✗	EM90 D25 W25 L100 Z03 ADKX 1204	102,00 €
ST ADKX 12 011 FTTE	✓	✗	EM90 D32 W32 L111 Z03 ADKX 1204	120,67 €
ST ADKX 12 012 FTTE	✗	✗	EM90 D32 W32 L201 Z03 ADKX 1204	132,67 €
ST ADKX 12 013 FTTE	✓	✗	EM90 D32 W32 L201 Z04 ADKX 1204	136,00 €

AOMT 1848 MTSBSH



KOD	Stok Stock	Inter Cooland	Kesici Uç Uyumluluğu / Insert Suitability	FİYAT PRICE
			MTSBSH AOMT 184804	EURO
ST AOMT 18 001 MTSBSH	✓	✗	EM90 D25 W25 L150 Z02 AOMT 184804	117,67 €
ST AOMT 18 002 MTSBSH	✓	✗	EM90 D32 W32 L150 Z03 AOMT 184804	126,67 €

AOMT 1236 MTSBSH



KOD	Stok Stock	Inter Cooland	Kesici Uç Uyumluluğu / Insert Suitability		FİYAT PRICE
			MTSBSH AOMT 1236		EURO
ST AOMT 12 001 MTSBSH	✓	✓	EM90 D16 W16 L150 Z02 AOMT 1236		99,00 €
ST AOMT 12 002 MTSBSH	✓	✓	EM90 D17 W16 L150 Z02 AOMT 1236		105,33 €
ST AOMT 12 003 MTSBSH	✓	✓	EM90 D20 W20 L150 Z03 AOMT 1236		111,33 €
ST AOMT 12 004 MTSBSH	✓	✓	EM90 D21 W20 L150 Z03 AOMT 1236		111,33 €
ST AOMT 12 005 MTSBSH	✓	✓	EM90 D25 W24 L150 Z04 AOMT 1236		114,33 €
ST AOMT 12 006 MTSBSH	✓	✓	EM90 D25 W25 L150 Z04 AOMT 1236		111,33 €
ST AOMT 12 007 MTSBSH	✓	✓	EM90 D32 W32 L150 Z04 AOMT 1236		120,67 €
ST AOMT 12 008 MTSBSH	✓	✓	EM90 D32 W32 L160 Z04 AOMT 1236		126,67 €
ST AOMT 12 010 MTSBSH	✓	✓	EM90 D20 W20 L200 Z03 AOMT 1236		126,67 €
ST AOMT 12 011 MTSBSH	✓	✓	EM90 D32 W32 L200 Z04 AOMT 1236		139,00 €
ST AOMT 12 012 MTSBSH	✓	✓	EM90 D25 W25 L200 Z04 AOMT 1236		120,33 €

APMT 11T3..



KOD	Stok Stock	Inter Cooland	Kesici Uç Uyumluluğu / Insert Suitability		FİYAT PRICE
			APMT 11T3..		EURO
ST APMT 11 002	✓	✗	EM90 D16 W16 L120 Z02 APMT 11T3		80,67 €
ST APMT 11 003	✓	✗	EM90 D16 W16 L150 Z02 APMT 11T3		90,00 €
ST APMT 11 006	✓	✗	EM90 D18 W16 L100 Z02 APMT 11T3		75,67 €
ST APMT 11 008	✓	✗	EM90 D20 W20 L120 Z03 APMT 11T3		100,00 €
ST APMT 11 009	✓	✗	EM90 D20 W20 L150 Z03 APMT 11T3		110,00 €
ST APMT 11 014	✓	✗	EM90 D25 W25 L120 Z03 APMT 11T3		105,00 €
ST APMT 11 015	✓	✗	EM90 D25 W25 L150 Z03 APMT 11T3		115,00 €
ST APMT 11 019	✓	✗	EM90 D32 W32 L200 Z04 APMT 11T3		133,00 €

XO..0903 SCO



KOD	Stok Stock	Inter Cooland	Kesici Uç Uyumluluğu / Insert Suitability		FİYAT PRICE
			SCO XO.. 0903		EURO
ST XO..09 001 SCO	✓	✓	EM90 D16 W16 L100 Z02 XO..0903		74,33 €
ST XO..09 002 SCO	✓	✗	EM90 D16 W16 L130 Z02 XO..0903		83,67 €
ST XO..09 003 SCO	✓	✗	EM90 D16 W16 L150 Z02 XO..0903		89,67 €
ST XO..09 005 SCO	✓	✓	EM90 D20 W20 L120 Z03 XO..0903		89,67 €
ST XO..09 006 SCO	✓	✗	EM90 D20 W20 L150 Z03 XO..0903		92,67 €
ST XO..09 007 SCO	✓	✗	EM90 D20 W20 L200 Z03 XO..0903		114,33 €
ST XO..09 008 SCO	✓	✗	EM90 D25 W25 L150 Z03 XO..0903		108,33 €

XOMX 1204 SCO



XNEX 0403 SCO



APKT 1604 ZCC



KOD	Stok Stock	Inter Cooland	Kesici Uç Uyumluluğu / Insert Suitability		FIYAT PRICE
			SCO XOMX 1204..		EURO
ST XOMX 12 001 SCO	✓	X	EM90 D16 W16 L120 Z01 XOMX 1204		74,33 €
ST XOMX 12 002 SCO	✓	X	EM90 D16 W16 L150 Z01 XOMX 1204		80,33 €
ST XOMX 12 003 SCO	✓	X	EM90 D20 W20 L100 Z02 XOMX 1204		77,33 €
ST XOMX 12 004 SCO	✓	X	EM90 D20 W20 L120 Z02 XOMX 1204		80,33 €
ST XOMX 12 004 SCO (S)	✓	✓	EM90 D20 W20 L120 Z02 XOMX 1204 inter cooland		92,67 €
ST XOMX 12 005 SCO	✓	X	EM90 D20 W20 L150 Z02 XOMX 1204		92,67 €
ST XOMX 12 006 SCO	✓	X	EM90 D22 W20 L150 Z02 XOMX 1204		96,00 €
ST XOMX 12 007 SCO	✓	X	EM90 D25 W25 L120 Z03 XOMX 1204		102,00 €
ST XOMX 12 007 SCO (S)	✓	✓	EM90 D25 W25 L120 Z03 XOMX 1204 inter cooland		114,33 €
ST XOMX 12 008 SCO	✓	X	EM90 D25 W25 L150 Z03 XOMX 1204		108,33 €
ST XOMX 12 008 SCO (S)	✓	✓	EM90 D25 W25 L150 Z03 XOMX 1204 inter cooland		117,67 €
ST XOMX 12 009 SCO	✓	X	EM90 D32 W25 L150 Z04 XOMX 1204		117,67 €
ST XOMX 12 009 SCO (S)	✓	✓	EM90 D32 W25 L150 Z04 XOMX 1204 inter cooland		132,67 €
ST XOMX 12 010 SCO	✓	X	EM90 D25 W25 L100 Z03 XOMX 1204		96,00 €
ST XOMX 12 011 SCO	✓	X	EM90 D20 W20 L200 Z02 XOMX 1204		108,33 €
ST XOMX 12 012 SCO	✓	X	EM90 D25 W25 L200 Z03 XOMX 1204		120,67 €
ST XOMX 12 013 SCO	✓	X	EM90 D32 W25 L200 Z04 XOMX 1204		139,00 €

KOD	Stok Stock	Inter Cooland	Kesici Uç Uyumluluğu / Insert Suitability		FIYAT PRICE
			SCO XNEX 0403		EURO
ST XNEX 04 001 SCO	✓	✓	EM90 D18 W16 L150 Z02 XNEX 0403		126,67 €
ST XNEX 04 002 SCO	✓	✓	EM90 D18 W16 L200 Z02 XNEX 0403		129,67 €
ST XNEX 04 003 SCO	✓	✓	EM90 D20 W20 L150 Z03 XNEX 0403		136,00 €
ST XNEX 04 004 SCO	✓	✓	EM90 D21 W20 L150 Z03 XNEX 0403		139,00 €
ST XNEX 04 005 SCO	✓	✓	EM90 D21 W20 L200 Z03 XNEX 0403		145,33 €
ST XNEX 04 006 SCO	✓	✓	EM90 D25 W25 L150 Z04 XNEX 0403		148,33 €
ST XNEX 04 007 SCO	✓	✓	EM90 D26 W25 L150 Z04 XNEX 0403		151,33 €
ST XNEX 04 008 SCO	✓	✓	EM90 D32 W32 L150 Z04 XNEX 0403		154,33 €
ST XNEX 04 009 SCO	✓	✓	EM90 D25 W25 L200 Z04 XNEX 0403		160,67 €
ST XNEX 04 010 SCO	✓	✓	EM90 D26 W25 L200 Z04 XNEX 0403		160,67 €
ST XNEX 04 011 SCO	✓	✓	EM90 D32 W32 L200 Z04 XNEX 0403		173,00 €

KOD	Stok Stock	Inter Cooland	Kesici Uç Uyumluluğu / Insert Suitability		FIYAT PRICE
			ZCC APKT 1604..		EURO
ST APKT 16 001 ZCC	✓	X	EM90 D25 W25 L170 Z02 APKT 1604		105,33 €
ST APKT 16 002 ZCC	✓	X	EM90 D26 W25 L200 Z02 APKT 1604		117,67 €
ST APKT 16 003 ZCC	✓	X	EM90 D32 W32 L170 Z03 APKT 1604		117,67 €
ST APKT 16 004 ZCC	✓	X	EM90 D26 W25 L250 Z02 APKT 1604		132,67 €
ST APKT 16 026 ZCC	✓	X	EM90 D33 W32 L200 Z03 APKT 1604		129,67 €
ST APKT 16 027 ZCC	✓	X	EM90 D33 W32 L250 Z03 APKT 1604		142,00 €
ST APKT 16 028 ZCC	✓	X	EM90 D33 W32 L300 Z03 APKT 1604		154,33 €
ST APKT 16 029 ZCC	✓	X	EM90 D33 W32 L350 Z03 APKT 1604		179,00 €
ST APKT 16 030 ZCC	✓	X	EM90 D33 W32 L400 Z03 APKT 1604		225,33 €

APKT 11T3 ZCC



KOD	Stok Stock	Inter Cooland	Kesici Uç Uyumluluğu / Insert Suitability		FİYAT PRICE
			ZCC APKT 11T3		EURO
ST APKT 11 001 ZCC	✓	✗	EM90 D16 W16 L160 Z02 APKT 11T3		92,67 €
ST APKT 11 001 ZCC (S)	✓	✓	EM90 D16 W16 L160 Z02 APKT 11T3 inter cooland		108,33 €
ST APKT 11 002 ZCC	✓	✗	EM90 D16 W16 L200 Z02 APKT 11T3		102,00 €
ST APKT 11 002 ZCC (S)	✓	✓	EM90 D16 W16 L200 Z02 APKT 11T3 inter cooland		117,67 €
ST APKT 11 003 ZCC	✓	✗	EM90 D17 W16 L160 Z02 APKT 11T3		92,67 €
ST APKT 11 004 ZCC	✓	✗	EM90 D17 W16 L200 Z02 APKT 11T3		99,00 €
ST APKT 11 005 ZCC	✓	✗	EM90 D17 W16 L250 Z02 APKT 11T3		111,33 €
ST APKT 11 006 ZCC	✓	✗	EM90 D18 W16 L160 Z02 APKT 11T3		92,67 €
ST APKT 11 007 ZCC	✓	✓	EM90 D20 W20 L160 Z03 APKT 11T3		99,00 €
ST APKT 11 007 ZCC (S)	✓	✓	EM90 D20 W20 L160 Z03 APKT 11T3 inter cooland		114,33 €
ST APKT 11 008 ZCC	✓	✗	EM90 D21 W20 L160 Z03 APKT 11T3		102,00 €
ST APKT 11 009 ZCC	✓	✗	EM90 D21 W20 L200 Z03 APKT 11T3		108,33 €
ST APKT 11 010 ZCC	✓	✗	EM90 D21 W20 L250 Z03 APKT 11T3		120,67 €
ST APKT 11 011 ZCC	✓	✗	EM90 D25 W25 L160 Z03 APKT 11T3		117,67 €
ST APKT 11 012 ZCC	✓	✗	EM90 D26 W25 L160 Z03 APKT 11T3		120,67 €
ST APKT 11 013 ZCC	✓	✗	EM90 D26 W25 L200 Z03 APKT 11T3		120,67 €
ST APKT 11 014 ZCC	✓	✗	EM90 D26 W25 L250 Z03 APKT 11T3		132,67 €
ST APKT 11 015 ZCC	✓	✓	EM90 D20 W20 L200 Z03 APKT 11T3		117,67 €
ST APKT 11 016 ZCC	✓	✗	EM90 D16 W16 L100 Z02 APKT 11T3		83,67 €
ST APKT 11 017 ZCC	✓	✗	EM90 D20 W20 L120 Z03 APKT 11T3		89,67 €
ST APKT 11 018 ZCC	✓	✗	EM90 D25 W25 L120 Z03 APKT 11T3		108,33 €
ST APKT 11 019 ZCC	✓	✗	EM90 D25 W25 L200 Z03 APKT 11T3		123,33 €
ST APKT 11 020 ZCC	✓	✗	EM90 D32 W32 L200 Z04 APKT 11T3		136,00 €

APKT 0702 ZCC



KOD	Stok Stock	Inter Cooland	Kesici Uç Uyumluluğu / Insert Suitability		FİYAT PRICE
			ZCC APKT 0702		EURO
ST AP..07 001 ZCC	✓	✗	EM90 D10 W10 L130 Z02 AP.0702 ZCC		89,67 €
ST AP..07 002 ZCC	✓	✗	EM90 D12 W10 L130 Z02 AP.0702 ZCC		92,67 €
ST AP..07 003 ZCC	✓	✗	EM90 D12 W12 L130 Z02 AP.0702 ZCC		92,67 €
ST AP..07 004 ZCC	✓	✗	EM90 D14 W12 L130 Z03 AP.0702 ZCC		102,00 €
ST AP..07 007 ZCC	✓	✗	EM90 D10 W9 L130 Z02 AP.0702		89,67 €
ST AP..07 008 ZCC	✓	✗	EM90 D12 W10 L150 Z02 AP.0702		97,33 €
ST AP..07 009 ZCC	✓	✗	EM90 D12 W12 L150 Z02 AP.0702		97,33 €
ST AP..07 010 ZCC	✓	✗	EM90 D14 W12 L150 Z03 AP.0702		105,67 €

ANGX 1105 ZCC



KOD	Stok Stock	Inter Cooland	Kesici Uç Uyumluluğu / Insert Suitability		FIYAT PRICE
			ZCC ANGX 1105		EURO
ST ANGX 11 001 ZCC	✓	✓	EM90 D25 W25 L150 Z02 ANGX 1105		108,33 €
ST ANGX 11 002 ZCC	✓	✓	EM90 D32 W32 L150 Z03 ANGX 1105		120,67 €
ST ANGX 11 003 ZCC	x	✓	EM90 D40 W32 L150 Z04 ANGX 1105		132,67 €

LNKT 0804 ZCC



KOD	Stok Stock	Inter Cooland	Kesici Uç Uyumluluğu / Insert Suitability		FIYAT PRICE
			ZCC LNKT 0804		EURO
ST LNKT 08 001 ZCC	✓	✓	EM90 D20 W20 L160 Z02 LNKT 0804		105,33 €
ST LNKT 08 002 ZCC	✓	✓	EM90 D25 W25 L160 Z03 LNKT 0804		117,67 €
ST LNKT 08 003 ZCC	✓	✓	EM90 D32 W32 L160 Z04 LNKT 0804		123,33 €

WNHU 0604 ZCC



KOD	Stok Stock	Inter Cooland	Kesici Uç Uyumluluğu / Insert Suitability		FIYAT PRICE
			ZCC WNHU 0604		EURO
ST WNHU 06 001 ZCC	✓	✓	EM90 D25 W25 L160 Z02 WNHU 0604 ZCC		105,33 €
ST WNHU 06 002 ZCC	✓	✓	EM90 D26 W25 L200 Z02 WNHU 0604 ZCC		117,67 €
ST WNHU 06 003 ZCC	✓	✓	EM90 D32 W32 L160 Z03 WNHU 0604 ZCC		120,67 €

ADMT 1204 WLTR



ADMT 10T3 WLTR



ADMT 0803 WLTR



KOD	Stok Stock	Inter Cooland	Kesici Uç Uyumluluğu / Insert Suitability		FİYAT PRICE
			WLTR ADMT 1204		EURO
ST ADMT 12 001 WLTR	✓	X	EM90 D20 W20 L120 Z02 ADMT 1204		97,33 €
ST ADMT 12 001 WLTR (S)	✓	✓	EM90 D20 W20 L120 Z02 ADMT 1204 inter cooland		105,33 €
ST ADMT 12 002 WLTR	✓	X	EM90 D20 W20 L150 Z02 ADMT 1204		99,33 €
ST ADMT 12 003 WLTR	✓	X	EM90 D25 W25 L120 Z03 ADMT 1204		114,33 €
ST ADMT 12 003 WLTR (S)	✓	✓	EM90 D25 W25 L120 Z03 ADMT 1204 inter cooland		114,33 €
ST ADMT 12 004 WLTR	✓	X	EM90 D25 W25 L150 Z03 ADMT 1204		117,67 €
ST ADMT 12 005 WLTR	✓	X	EM90 D30 W25 L120 Z03 ADMT 1204		123,33 €
ST ADMT 12 006 WLTR	✓	X	EM90 D30 W25 L150 Z03 ADMT 1204		129,67 €
ST ADMT 12 007 WLTR	✓	X	EM90 D32 W32 L150 Z04 ADMT 1204		132,67 €
ST ADMT 12 007 WLTR (S)	✓	✓	EM90 D32 W32 L150 Z04 ADMT 1204 inter cooland		138,33 €
ST ADMT 12 008 WLTR	✓	X	EM90 D40 W32 L120 Z04 ADMT 1204		139,00 €
ST ADMT 12 009 WLTR	✓	X	EM90 D40 W32 L150 Z04 ADMT 1204		145,33 €

KOD	Stok Stock	Inter Cooland	Kesici Uç Uyumluluğu / Insert Suitability		FİYAT PRICE
			WLTR ADMT 10T3..		EURO
ST ADMT 10 002 WLTR	✓	X	EM90 D20 W20 L120 Z03 ADMT 10T3		99,00 €
ST ADMT 10 003 WLTR	✓	X	EM90 D25 W25 L120 Z03 ADMT 10T3		105,33 €

KOD	Stok Stock	Inter Cooland	Kesici Uç Uyumluluğu / Insert Suitability		FİYAT PRICE
			WLTR ADMT 0803		EURO
ST ADMT 08 001 WLTR	✓	X	EM90 D16 W16 L150 Z02 ADMT 0803		83,67 €
ST ADMT 08 001 WLTR (S)	✓	✓	EM90 D16 W16 L150 Z02 ADMT 0803 inter cooland		92,67 €
ST ADMT 08 002 WLTR	✓	X	EM90 D20 W16 L200 Z03 ADMT 0803		114,33 €
ST ADMT 08 003 WLTR	✓	X	EM90 D20 W20 L150 Z03 ADMT 0803		99,00 €
ST ADMT 08 004 WLTR	✓	X	EM90 D20 W20 L200 Z03 ADMT 0803		114,33 €
ST ADMT 08 005 WLTR	✓	X	EM90 D26 W25 L150 Z03 ADMT 0803		114,33 €
ST ADMT 08 006 WLTR	✓	X	EM90 D26 W25 L200 Z03 ADMT 0803		123,33 €

AP..0903 WLTR



KOD	Stok Stock	Inter Cooland	Kesici Uç Uyumluluğu / Insert Suitability	FIYAT PRICE
			WLTR AP..0903	EURO
ST AP..09 002 WLTR	✓	X	EM90 D16 W16 L120 Z02 AP.0903	83,67 €
ST AP..09 003 WLTR	✓	X	EM90 D16 W16 L150 Z02 AP.0903	89,67 €
ST AP..09 004 WLTR	✓	X	EM90 D16 W16 L200 Z02 AP.0903	99,00 €
ST AP..09 005 WLTR	✓	X	EM90 D20 W20 L120 Z03 AP.0903	92,67 €
ST AP..09 007 WLTR	✓	X	EM90 D20 W20 L200 Z03 AP.0903	117,67 €

LNHU 0904 WLTR



KOD	Stok Stock	Inter Cooland	Kesici Uç Uyumluluğu / Insert Suitability	FIYAT PRICE
			WLTR LNHU 0904	EURO
ST LNHU 09 001 WLTR	✓	✓	EM90 D20 W20 L120 Z03 LNHU 0904	92,67 €
ST LNHU 09 002 WLTR	✓	✓	EM90 D20 W20 L150 Z03 LNHU 0904	102,00 €
ST LNHU 09 003 WLTR	✓	✓	EM90 D25 W25 L120 Z04 LNHU 0904	108,33 €
ST LNHU 09 004 WLTR	✓	✓	EM90 D25 W25 L150 Z03 LNHU 0904	117,67 €
ST LNHU 09 005 WLTR	✓	✓	EM90 D32 W32 L120 Z05 LNHU 0904	129,67 €

LNHU 1306 WLTR



KOD	Stok Stock	Inter Cooland	Kesici Uç Uyumluluğu / Insert Suitability	FIYAT PRICE
			WLTR LNHU 1306	EURO
ST LNHU 13 001 WLTR	✓	✓	EM90 D30 W25 L150 Z03 LNHU 1306	117,67 €
ST LNHU 13 003 WLTR	✓	✓	EM90 D40 W32 L150 Z04 LNHU 1306	136,00 €
ST LNHU 13 004 WLTR	✓	✓	EM90 D40 W40 L200 Z04 LNHU 1306	163,67 €

AXMT 1235 SMTM



KOD	Stok Stock	Inter Cooland	Kesici Uç Uyumluluğu / Insert Suitability	FIYAT PRICE
			SMTM AXMT 1235	EURO
ST AXMT 1235 001 SMTM	X	X	EM90 D12 W12 L100 Z01 AXMT 1235	80,33 €
ST AXMT 1235 002 SMTM	X	X	EM90 D14 W12 L100 Z01 AXMT 1235	89,67 €
ST AXMT 1235 003 SMTM	X	X	EM90 D16 W16 L100 Z01 AXMT 1235	99,00 €
ST AXMT 1235 004 SMTM	X	X	EM90 D18 W16 L100 Z02 AXMT 1235	102,00 €
ST AXMT 1235 005 SMTM	X	X	EM90 D20 W20 L100 Z03 AXMT 1235	105,33 €

AXMT 0602 SMTM



KOD	Stok Stock	Inter Cooland	Kesici Uç Uyumluluğu / Insert Suitability	FIYAT PRICE
			SMTM AXMT 0602	EURO
ST AXMT 06 001 SMTM	✓	X	EM90 D10 W10 L75 Z02 AXMT 0602	89,67 €
ST AXMT 06 002 SMTM	✓	X	EM90 D12 W12 L120 Z02 AXMT 0602	89,67 €
ST AXMT 06 003 SMTM	✓	X	EM90 D12 W12 L90 Z03 AXMT 0602	92,67 €
ST AXMT 06 004 SMTM	✓	X	EM90 D14 W16 L100 Z03 AXMT 0602	108,33 €

APKT 1003 PLBT



KOD	Stok Stock	Inter Cooland	Kesici Uç Uyumluluğu / Insert Suitability	FIYAT PRICE
			PLBT APKT 1003..	EURO
ST APKT 10 001 PLT	X	X	EM90 D16 W16 L120 Z02 APKT 1003	92,67 €
ST APKT 10 002 PLT	✓	X	EM90 D16 W16 L150 Z02 APKT 1003	99,00 €
ST APKT 10 003 PLT	X	X	EM90 D20 W20 L120 Z03 APKT 1003	102,00 €
ST APKT 10 004 PLT	✓	X	EM90 D20 W20 L150 Z03 APKT 1003	105,33 €
ST APKT 10 005 PLT	X	X	EM90 D25 W25 L120 Z03 APKT 1003	114,33 €
ST APKT 10 006 PLT	✓	X	EM90 D25 W25 L150 Z03 APKT 1003	120,67 €

XPET 0602 PLBT



KOD	Stok Stock	Inter Cooland	Kesici Uç Uyumluluğu / Insert Suitability		FİYAT PRICE
			PLBT XPET 0602		EURO
ST XPET 06 001 PLBT	✓	✗	EM90 D08 W08 L100 Z01	XPET 0602	74,33 €
ST XPET 06 002 PLBT	✓	✗	EM90 D08 W08 L120 Z01	XPET 0602	74,33 €
ST XPET 06 003 PLBT	✓	✗	EM90 D10 W9 L120 Z02	XPET 0602	80,33 €
ST XPET 06 004 PLBT	✓	✗	EM90 D10 W10 L100 Z02	XPET 0602	80,33 €
ST XPET 06 006 PLBT	✓	✗	EM90 D12 W12 L100 Z03	XPET 0602	89,67 €
ST XPET 06 007 PLBT	✓	✗	EM90 D12 W11 L120 Z03	XPET 0602	89,67 €
ST XPET 06 008 PLBT	✓	✗	EM90 D12 W12 L120 Z03	XPET 0602	89,67 €
ST XPET 06 009 PLBT	✓	✗	EM90 D14 W12 L140 Z03	XPET 0602	99,00 €
ST XPET 06 010 PLBT	✓	✗	EM90 D16 W12 L160 Z04	XPET 0602	111,33 €

LN..0804 I



KOD	Stok Stock	Inter Cooland	Kesici Uç Uyumluluğu / Insert Suitability		FİYAT PRICE
			I LNMT 0804		EURO
ST LN..08 001 I	✓	✗	EM90 D16 W16 L120 Z02	LNMT 0804	117,67 €
ST LN..08 002 I	✓	✗	EM90 D18 W20 L120 Z02	LNMT 0804	120,67 €
ST LN..08 003 I	✓	✗	EM90 D20 W20 L120 Z03	LNMT 0804	126,67 €
ST LN..08 005 I	✓	✗	EM90 D25 W25 L150 Z04	LNMT 0804	142,00 €
ST LN..08 008 I	✓	✗	EM90 D30 W25 L150 Z04	LNMT 0804	129,67 €
ST LN..08 009 I	✓	✗	EM90 D32 W32 L200 Z04	LNMT 0804	157,67 €

AN..1205 I



KOD	Stok Stock	Inter Cooland	Kesici Uç Uyumluluğu / Insert Suitability		FİYAT PRICE
			I ANKX 1205		EURO
ST ANKX 12 002 I	✗	✗	EM90 D30 W25 L150 Z02	ANKX 1205	105,33 €
ST ANKX 12 003 I	✓	✓	EM90 D30 W25 L120 Z03	ANKX 1205	102,00 €
ST ANKX 12 005 I	✓	✓	EM90 D35 W32 L120 Z03	ANKX 1205	105,33 €
ST ANKX 12 006 I	✓	✓	EM90 D35 W32 L150 Z03	ANKX 1205	111,33 €
ST ANKX 12 007 I	✗	✗	EM90 D30 W30 L110 Z03	ANKX 1205	105,33 €
ST ANKX 12 008 I	✓	✓	EM90 D30 W25 L200 Z03	ANKX 1205	105,33 €

TP..1003 I



KOD	Stok Stock	Inter Cooland	Kesici Uç Uyumluluğu / Insert Suitability		FİYAT PRICE
			I TPKT 1003		EURO
ST TPKT 10 001 I	✓	✓	EM90 D25 W25 L120 Z03 TPKT 1003		139,00 €
ST TPKT 10 002 I	✓	✓	EM90 D25 W25 L150 Z03 TPKT 1003		148,33 €
ST TPKT 10 004 I	✓	✓	EM90 D32 W32 L150 Z04 TPKT 1003		170,00 €

ADKT 1505 I

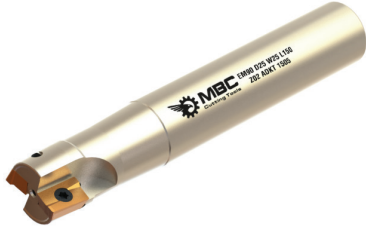

KOD	Stok Stock	Inter Cooland	Kesici Uç Uyumluluğu / Insert Suitability		FİYAT PRICE
			I ADKT 1505		EURO
ST ADKT 15 001 I	✓	✓	EM90 D25 W25 L150 Z02 ADKT 1505		102,00 €
ST ADKT 15 002 I	✓	✓	EM90 D32 W32 L150 Z03 ADKT 1505		111,33 €
ST ADKT 15 003 I	✓	✓	EM90 D40 W32 L150 Z04 ADKT 1505		117,67 €

ANKX 0904 I



KOD	Stok Stock	Inter Cooland	Kesici Uç Uyumluluğu / Insert Suitability		FİYAT PRICE
			I ANKX 0904		EURO
ST ANKX 09 001 I	✓	✓	EM90 D16 W16 L150 Z02 ANKX 0904		102,00 €
ST ANKX 09 002 I	✓	✓	EM90 D20 W20 L150 Z02 ANKX 0904		105,33 €
ST ANKX 09 004 I	✓	✓	EM90 D20 W20 L150 Z03 ANKX 0904		105,33 €
ST ANKX 09 005 I	✓	✓	EM90 D25 W25 L150 Z03 ANKX 0904		114,33 €
ST ANKX 09 006 I	✓	✓	EM90 D32 W32 L150 Z04 ANKX 0904		129,67 €

TCKT 0703 I



KOD	Stok Stock	Inter Cooland	Kesici Uç Uyumluluğu / Insert Suitability	FIYAT PRICE
			I TCKT 0703	EURO
ST TCKT 07 001 I	✓	✓	EM90 D16 W16 L150 Z02 TCKT 0703	105,33 €
ST TCKT 07 002 I	✓	✓	EM90 D20 W20 L150 Z03 TCKT 0703	111,33 €

LNGU 1104 KNNMTL



KOD	Stok Stock	Inter Cooland	Kesici Uç Uyumluluğu / Insert Suitability	FIYAT PRICE
			KNNMTL LNGU 110408	EURO
ST LNGU 11 001 KNM	✓	✓	EM90 D16 W16 L120 Z02 LNGU 110408	92,67 €
ST LNGU 11 002 KNM	✓	✓	EM90 D20 W20 L120 Z02 LNGU 110408	102,00 €
ST LNGU 11 003 KNM	✓	✓	EM90 D25 W25 L120 Z03 LNGU 110408	114,33 €
ST LNGU 11 004 KNM	✓	✓	EM90 D25 W25 L150 Z03 LNGU 110408	120,67 €
ST LNGU 11 005 KNM	✓	✓	EM90 D16 W16 L150 Z02 LNGU 110408	102,00 €
ST LNGU 11 006 KNM	✓	✓	EM90 D20 W20 L150 Z02 LNGU 110408	108,33 €

EDPT 1404 KNNMTL



KOD	Stok Stock	Inter Cooland	Kesici Uç Uyumluluğu / Insert Suitability	FIYAT PRICE
			KNNMTL EDPT 1404	EURO
ST EDPT 14 001 KNM	✓	X	EM90 D20 W20 L120 Z02 EDPT 1404	108,33 €
ST EDPT 14 002 KNM	✓	X	EM90 D20 W20 L150 Z02 EDPT 1404	114,33 €
ST EDPT 14 003 KNM	✓	X	EM90 D25 W25 L120 Z03 EDPT 1404	123,33 €
ST EDPT 14 004 KNM	✓	X	EM90 D25 W25 L150 Z03 EDPT 1404	132,67 €

EDPT 10T3/1805 KNNMTL



KOD	Stok Stock	Inter Cooland	Kesici Uç Uyumluluğu / Insert Suitability		FİYAT PRICE
			KNNMTL EDPT 10T3/1805		EURO
ST EDPT 10 001 KNM	✓	✗	EM90 D16 W16 L150 Z02	EDPT 10T3	108,33 €
ST EDPT 10 002 KNM	✓	✗	EM90 D18 W16 L150 Z02	EDPT 10T3	111,33 €
ST EDPT 10 003 KNM	✓	✗	EM90 D20 W20 L150 Z03	EDPT 10T3	114,33 €
ST EDPT 10 004 KNM	✓	✗	EM90 D25 W25 L150 Z03	EDPT 10T3	132,67 €
ST EDPT 10 005 KNM	✓	✗	EM90 D17 W16 L150 Z02	EDPT 10T3	114,33 €
ST EDPT 10 006 KNM	✓	✗	EM90 D21 W20 L150 Z03	EDPT 10T3	117,67 €
ST EDPT 10 007 KNM	✓	✗	EM90 D16 W14 L120 Z02	EDPT 10T3	105,33 €
ST EDPT 10 008 KNM	✓	✗	EM90 D17 W16 L200 Z02	EDPT 10T3	120,67 €
ST EDPT 10 009 KNM	✓	✗	EM90 D22 W20 L200 Z03	EDPT 10T3	129,67 €
ST EDPT 10 010 KNM	✓	✗	EM90 D16 W16 L120 Z02	EDPT 10T3	96,00 €
ST EDPT 10 011 KNM	✓	✗	EM90 D22 W20 L150 Z03	EDPT 10T3	120,67 €
ST EDPT 18 005 KNM	✓	✗	EM90 D25 W25 L200 Z02	EDPT 1805	136,00 €
ST EDPT 18 006 KNM	✓	✗	EM90 D32 W32 L200 Z03	EDPT 1805	148,33 €

LNMX 1006 KRLY



KOD	Stok Stock	Inter Cooland	Kesici Uç Uyumluluğu / Insert Suitability		FİYAT PRICE
			KRLY LNMX 1006		EURO
ST LNMX 10 001 KRLY	✓	✓	EM90 D16 W16 L90 Z01	LNMX 1006	68,00 €
ST LNMX 10 003 KRLY	✓	✓	EM90 D18 W16 L120 Z02	LNMX 1006	87,84 €
ST LNMX 10 005 KRLY	✓	✓	EM90 D20 W20 L100 Z02	LNMX 1006	92,67 €
ST LNMX 10 006 KRLY	✓	✓	EM90 D20 W20 L150 Z02	LNMX 1006	99,56 €
ST LNMX 10 008 KRLY	✓	✓	EM90 D25 W25 L115 Z02	LNMX 1006	111,34 €
ST LNMX 10 009 KRLY	✓	✓	EM90 D25 W25 L115 Z03	LNMX 1006	114,34 €
ST LNMX 10 010 KRLY	✓	✓	EM90 D25 W25 L150 Z03	LNMX 1006	117,67 €
ST LNMX 10 012 KRLY	✓	✓	EM90 D32 W32 L125 Z04	LNMX 1006	120,67 €
ST LNMX 10 013 KRLY	✓	✓	EM90 D40 W32 L130 Z04	LNMX 1006	132,67 €
ST LNMX 10 014 KRLY	✓	✓	EM90 D40 W32 L130 Z05	LNMX 1006	136,00 €
ST LNMX 10 016 KRLY	✓	✓	EM90 D32 W32 L200 Z04	LNMX 1006	129,67 €
ST LNMX 10 017 KRLY	✓	✓	EM90 D26 W25 L200 Z03	LNMX 1006	132,67 €
ST LNMX 10 018 KRLY	✓	✓	EM90 D32 W32 L150 Z04	LNMX 1006	120,05 €

XNKT 0604 KRLY



KOD	Stok Stock	Inter Cooland	Kesici Uç Uyumluluğu / Insert Suitability		FİYAT PRICE
			KRLY XNKT 0604/0805		EURO
ST XNKT 06 001 KRLY	✓	✓	EM90 D18 W20 L150 Z02	XNKT 0604	117,67 €
ST XNKT 06 002 KRLY	✓	✓	EM90 D20 W20 L150 Z02	XNKT 0604	120,67 €
ST XNKT 06 003 KRLY	✓	✓	EM90 D22 W20 L150 Z02	XNKT 0604	129,67 €
ST XNKT 06 004 KRLY	✓	✓	EM90 D25 W25 L150 Z03	XNKT 0604	142,00 €
ST XNKT 06 005 KRLY	✓	✓	EM90 D26 W25 L150 Z03	XNKT 0604	145,33 €
ST XNKT 06 006 KRLY	✓	✓	EM90 D32 W32 L150 Z04	XNKT 0604	160,67 €
ST XNKT 06 007 KRLY	✓	✓	EM90 D21 W20 L200 Z02	XNKT 0604	160,67 €
ST XNKT 06 010 KRLY	✓	✓	EM90 D25 W25 L200 Z03	XNKT 0604	166,67 €
ST XNKT 06 011 KRLY	✓	✓	EM90 D26 W25 L200 Z03	XNKT 0604	170,00 €
ST XNKT 06 012 KRLY	✓	✓	EM90 D21 W20 L150 Z02	XNKT 0604	160,67 €
ST XNKT 08 008 KRLY	✓	✓	EM90 D32 W32 L150 Z03	XNKT 0805	173,00 €
ST XNKT 08 009 KRLY	✓	✓	EM90 D42 W32 L150 Z04	XNKT 0805	188,33 €
ST XNKT 08 010 KRLY	✓	✓	EM90 D32 W32 L200 Z03	XNKT 0805	179,00 €
ST XNKT 08 012 KRLY	✓	✓	EM90 D40 W32 L200 Z04	XNKT 0805	188,33 €

APMT 11T308 KRLY



ST APKT 1003 YG



R390 11T3 SNDVK



KOD	Stok Stock	Inter Cooland	Kesici Uç Uyumluluğu / Insert Suitability		FIYAT PRICE
			KRLY APMT 11T3		EURO
ST APMT 11 001 KRLY	✓	X	EM90 D16 W16 L120 Z02 APMT 11T3		68,00 €
ST APMT 11 002 KRLY	✓	X	EM90 D16 W16 L150 Z02 APMT 11T3		89,67 €
ST APMT 11 003 KRLY	✓	X	EM90 D16 W16 L200 Z02 APMT 11T3		102,00 €
ST APMT 11 004 KRLY	✓	X	EM90 D17 W16 L120 Z02 APMT 11T3		71,00 €
ST APMT 11 005 KRLY	✓	X	EM90 D20 W20 L120 Z03 APMT 11T3		88,00 €
ST APMT 11 006 KRLY	✓	X	EM90 D21 W20 L120 Z03 APMT 11T3		89,67 €
ST APMT 11 007 KRLY	✓	X	EM90 D22 W20 L120 Z03 APMT 11T3		89,67 €
ST APMT 11 008 KRLY	✓	X	EM90 D20 W20 L200 Z03 APMT 11T3		108,33 €
ST APMT 11 009 KRLY	✓	X	EM90 D21 W20 L200 Z03 APMT 11T3		111,33 €
ST APMT 11 010 KRLY	✓	X	EM90 D25 W25 L150 Z03 APMT 11T3		108,33 €
ST APMT 11 011 KRLY	✓	X	EM90 D18 W16 L120 Z02 APMT 11T3		71,00 €
ST APMT 11 012 KRLY	✓	X	EM90 D20 W20 L150 Z03 APMT 11T3		99,00 €
ST APMT 11 013 KRLY	✓	X	EM90 D17 W16 L150 Z02 APMT 11T3		92,67 €
ST APMT 11 014 KRLY	✓	X	EM90 D21 W20 L150 Z03 APMT 11T3		102,00 €
ST APMT 11 015 KRLY	✓	X	EM90 D22 W20 L150 Z03 APMT 11T3		102,00 €

KOD	Stok Stock	Inter Cooland	Kesici Uç Uyumluluğu / Insert Suitability		FIYAT PRICE
			YG APKT 1003		EURO
ST APKT 10 004 YG	✓	X	EM90 D17 W16 L200 Z02 APKT 1003 YG		83,67 €
ST APKT 10 005 YG	✓	X	EM90 D17 W16 L300 Z02 APKT 1003 YG		132,67 €
ST APKT 10 006 YG	✓	X	EM90 D21 W20 L200 Z02 APKT 1003 YG		123,33 €
ST APKT 10 007 YG	✓	X	EM90 D21 W20 L300 Z02 APKT 1003 YG		142,00 €

KOD	Stok Stock	Inter Cooland	Kesici Uç Uyumluluğu / Insert Suitability		FIYAT PRICE
			SNDVK R390-11T3		EURO
ST R390 11 001 SNDVK	✓	X	EM90 D16 W16 L150 Z02 R390 11T3		86,67 €
ST R390 11 001 SNDVK (S)	✓	✓	EM90 D16 W16 L150 Z02 R390 11T3 inter cooland		99,00 €
ST R390 11 002 SNDVK	✓	X	EM90 D20 W20 L150 Z03 R390 11T3		92,67 €
ST R390 11 002 SNDVK (S)	✓	✓	EM90 D20 W20 L150 Z03 R390 11T3 inter cooland		105,33 €
ST R390 11 003 SNDVK	✓	X	EM90 D25 W25 L150 Z03 R390 11T3		99,00 €
ST R390 11 003 SNDVK (S)	✓	✓	EM90 D25 W25 L150 Z03 R390 11T3 inter cooland		114,33 €
ST R390 11 004 SNDVK	✓	X	EM90 D20 W20 L100 Z03 R390 11T3		74,33 €
ST R390 11 005 SNDVK	✓	X	EM90 D16 W16 L100 Z02 R390 11T3		68,00 €
ST R390 11 006 SNDVK	✓	X	EM90 D25 W25 L100 Z03 R390 11T3		80,33 €

R390 1704 SNDVK



KOD	Stok Stock	Inter Cooland	Kesici Uç Uyumluluğu / Insert Suitability		FİYAT PRICE
			SNDVK R390-1704		EURO
ST R390 17 001 SNDVK	✓	✗	EM90 D25 W25 L150 Z02 R390 1704		108,33 €
ST R390 17 001 SNDVK (S)	✓	✓	EM90 D25 W25 L150 Z02 R390 1704 inter cooland		120,67 €
ST R390 17 002 SNDVK	✓	✗	EM90 D32 W32 L150 Z03 R390 1704		126,67 €
ST R390 17 002 SNDVK (S)	✓	✓	EM90 D32 W32 L150 Z03 R390 1704 inter cooland		142,00 €
ST R390 17 003 SNDVK	✓	✗	EM90 D40 W25 L150 Z04 R390 1704		139,00 €

ANHG 1005 VNDRT



KOD	Stok Stock	Inter Cooland	Kesici Uç Uyumluluğu / Insert Suitability		FİYAT PRICE
			VNDRT ANHG 1005		EURO
ST ANHG 10 001 VNDRT	✓	✓	EM90 D20 W20 L90 Z02 ANHG 1005		89,67 €
ST ANHG 10 002 VNDRT	✓	✓	EM90 D20 W20 L120 Z02 ANHG 1005		99,00 €
ST ANHG 10 003 VNDRT	✓	✓	EM90 D20 W20 L150 Z02 ANHG 1005		105,33 €
ST ANHG 10 004 VNDRT	✓	✓	EM90 D25 W25 L100 Z03 ANHG 1005		117,67 €
ST ANHG 10 005 VNDRT	✓	✓	EM90 D25 W25 L150 Z03 ANHG 1005		129,67 €
ST ANHG 10 006 VNDRT	✓	✓	EM90 D32 W32 L110 Z03 ANHG 1005		136,00 €

LNGX 1205 PRMT/VNDRT



KOD	Stok Stock	Inter Cooland	Kesici Uç Uyumluluğu / Insert Suitability		FİYAT PRICE
			PRMT/VNDRT LNGX 1205		EURO
ST LNGX 12 001 VNDRT	✓	✗	EM90 D25 W25 L150 Z02 LNGX 1205		114,33 €
ST LNGX 12 002 VNDRT	✓	✗	EM90 D32 W32 L150 Z03 LNGX 1205		123,33 €

TNGX 1004 PRMT



KOD	Stok Stock	Inter Cooland	Kesici Uç Uyumluluğu / Insert Suitability		FİYAT PRICE
			PRMT TNGX 1004		EURO
ST TNGX 10 001 PRMT	✓	✓	EM90 D18 W16 L150 Z02 TNGX 1004		129,67 €
ST TNGX 10 002 PRMT	✓	✓	EM90 D21 W20 L150 Z03 TNGX 1004		139,00 €
ST TNGX 10 003 PRMT	✓	✓	EM90 D26 W25 L150 Z04 TNGX 1004		148,33 €
ST TNGX 10 004 PRMT	✓	✓	EM90 D26 W25 L200 Z04 TNGX 1004		160,67 €
ST TNGX 10 005 PRMT	✓	✓	EM90 D33 W32 L150 Z05 TNGX 1004		154,33 €
ST TNGX 10 006 PRMT	✓	✓	EM90 D33 W32 L200 Z05 TNGX 1004		166,67 €

ADMX 11T3 PRMT



AXMT 0602 TT



4NKT 0402 TT



4NKT 0603 TT



KOD	Stok Stock	Inter Cooland	Kesici Uç Uyumluluğu / Insert Suitability		FİYAT PRICE
			PRMT ADMX 11T3		EURO
ST ADMX 11 001 PRMT	✓	✗	EM90 D12 W12 L120 Z01 ADMX 11T3		86,67 €
ST ADMX 11 002 PRMT	✓	✗	EM90 D16 W16 L150 Z02 ADMX 11T3		99,00 €
ST ADMX 11 002 PRMT (S)	✓	✓	EM90 D16 W16 L150 Z02 ADMX 11T3 inter cooland		108,33 €
ST ADMX 11 003 PRMT	✓	✗	EM90 D20 W20 L150 Z03 ADMX 11T3		111,33 €
ST ADMX 11 003 PRMT (S)	✓	✓	EM90 D20 W20 L150 Z03 ADMX 11T3 inter cooland		120,67 €
ST ADMX 11 004 PRMT	✓	✗	EM90 D25 W25 L200 Z03 ADMX 11T3		129,67 €
ST ADMX 11 005 PRMT	✓	✗	EM90 D32 W32 L200 Z04 ADMX 11T3		151,33 €
ST ADMX 11 006 PRMT (S)	✓	✓	EM90 D25 W25 L200 Z04 ADMX 11T3 inter cooland		136,00 €

KOD	Stok Stock	Inter Cooland	Kesici Uç Uyumluluğu / Insert Suitability		FİYAT PRICE
			TT AXMT 0602		EURO
ST AXMT 06 001 TT	✓	✗	EM90 D10 W9 L120 Z02 AXMT 0602		92,67 €
ST AXMT 06 002 TT	✓	✗	EM90 D11 W10 L100 Z02 AXMT 0602		96,00 €
ST AXMT 06 003 TT	✓	✗	EM90 D12 W11 L120 Z02 AXMT 0602		102,00 €

KOD	Stok Stock	Inter Cooland	Kesici Uç Uyumluluğu / Insert Suitability		FİYAT PRICE
			TT 4NKT 0402		EURO
ST 4NKT 04 001 TT	✓	✗	EM90 D10 W10 L100 Z02 4NKT 0402		102,00 €
ST 4NKT 04 002 TT	✓	✗	EM90 D12 W12 L120 Z03 4NKT 0402		117,67 €
ST 4NKT 04 003 TT	✓	✗	EM90 D16 W16 L150 Z04 4NKT 0402		108,33 €

KOD	Stok Stock	Inter Cooland	Kesici Uç Uyumluluğu / Insert Suitability		FİYAT PRICE
			TT 4NKT 0603		EURO
ST 4NKT 06 001 TT	✓	✗	EM90 D16 W16 L120 Z02 4NKT 0603		92,67 €
ST 4NKT 06 002 TT (S)	✓	✓	EM90 D16 W16 L150 Z02 4NKT 0603 inter cooland		117,67 €
ST 4NKT 06 003 TT	✓	✗	EM90 D17 W16 L150 Z02 4NKT 0603		111,33 €
ST 4NKT 06 003 TT (S)	✓	✓	EM90 D17 W16 L150 Z02 4NKT 0603 inter cooland		117,67 €
ST 4NKT 06 004 TT (S)	✓	✗	EM90 D17 W16 L200 Z02 4NKT 0603 inter cooland		120,67 €
ST 4NKT 06 005 TT (S)	✓	✓	EM90 D20 W20 L160 Z03 4NKT 0603 inter cooland		139,00 €
ST 4NKT 06 006 TT (S)	✓	✓	EM90 D21 W20 L200 Z03 4NKT 0603 inter cooland		132,67 €
ST 4NKT 06 007 TT (S)	✓	✓	EM90 D25 W25 L200 Z03 4NKT 0603 inter cooland		142,00 €
ST 4NKT 06 008 TT (S)	✓	✓	EM90 D26 W25 L200 Z03 4NKT 0603 inter cooland		145,33 €
ST 4NKT 06 010 TT (S)	✓	✓	EM90 D20 W20 L120 Z03 4NKT 0603 inter cooland		105,33 €
ST 4NKT 06 012 TT (S)	✓	✓	EM90 D25 W25 L150 Z03 4NKT 0603 inter cooland		136,00 €
ST 4NKT 06 013 TT (S)	✓	✓	EM90 D25 W25 L120 Z04 4NKT 0603 inter cooland		118,00 €
ST 4NKT 06 015 TT (S)	✓	✓	EM90 D18 W16 L150 Z02 4NKT 0603 inter cooland		117,67 €
ST 4NKT 06 016 TT (S)	✓	✓	EM90 D22 W20 L160 Z03 4NKT 0603 inter cooland		139,00 €
ST 4NKT 06 021 TT (S)	✓	✓	EM90 D21 W20 L160 Z03 4NKT 0603 inter cooland		139,00 €

6NGU 0604 TT



KOD	Stok Stock	Inter Cooland	Kesici Uç Uyumluluğu / Insert Suitability		FIYAT PRICE
			TT 6NGU 0604		EURO
ST 6NGU 06 004 TT	✓	✓	EM90 D32 W32 L150 Z03 6NGU 0604		160,67 €
ST 6NGU 06 005 TT	✓	✓	EM90 D25 W25 L150 Z02 6NGU 0604		129,67 €

2PKT 0503 TT



KOD	Stok Stock	Inter Cooland	Kesici Uç Uyumluluğu / Insert Suitability		FIYAT PRICE
			TT 2PKT 0503		EURO
ST 2PKT 05 001 TT	✓	✗	EM90 D12 W11 L120 Z02 2PKT 0503		108,33 €
ST 2PKT 05 002 TT	✓	✗	EM90 D12 W12 L120 Z02 2PKT 0503		108,33 €

3PKT 1004 TT



KOD	Stok Stock	Inter Cooland	Kesici Uç Uyumluluğu / Insert Suitability		FIYAT PRICE
			TT 3PKT 1004		EURO
ST 3PKT 1004 001 TT	✓	✓	EM90 D20 W20 L150 Z02 3PKT 1004		132,67 €
ST 3PKT 1004 002 TT	✓	✓	EM90 D25 W25 L150 Z03 3PKT 1004		142,00 €
ST 3PKT 1004 003 TT	✓	✓	EM90 D32 W32 L150 Z04 3PKT 1004		154,33 €

3PKT 1505 TT



KOD	Stok Stock	Inter Cooland	Kesici Uç Uyumluluğu / Insert Suitability		FIYAT PRICE
			TT 3PKT 1505		EURO
ST 3PKT 15 001 TT	✓	✓	EM90 D32 W25 L150 Z03 3PKT 1505 TT		149,33 €
ST 3PKT 15 003 TT	✓	✓	EM90 D32 W32 L200 Z03 3PKT 1505 TT		161,67 €

Lütfen Sipariş vermeden önce stok durumunu sorunuz.
Please ask before ordering, stock status.

L: Sol / Left

R: Sağ / Right

✓ Stokta / In Stock

✗ Stokta Yok / Non Stock

APKT 09T3 TT



KOD	Stok Stock	Inter Cooland	Kesici Uç Uyumluluğu / Insert Suitability		FİYAT PRICE
			TT APKT 09T3		EURO
ST APKT 09 001 TT	✓	✗	EM90 D16 W15 L150 Z02 APKT 09T3		99,00 €
ST APKT 09 002 TT	✓	✗	EM90 D17 W16 L200 Z02 APKT 09T3		117,67 €
ST APKT 09 003 TT	✓	✗	EM90 D21 W20 L200 Z03 APKT 09T3		120,67 €

BDMT 1103 WDA



KOD	Stok Stock	Inter Cooland	Kesici Uç Uyumluluğu / Insert Suitability		FİYAT PRICE
			WDA BDMT 1103		EURO
ST BDMT 11 002 WDA	✗	✗	EM90 D16 W16 L150 Z02 BDMT 1103		89,67 €
ST BDMT 11 004 WDA	✗	✗	EM90 D20 W20 L150 Z03 BDMT 1103		105,33 €
ST BDMT 11 005 WDA	✗	✗	EM90 D25 W25 L120 Z03 BDMT 1103		114,33 €

XDPT 1104 WDA



KOD	Stok Stock	Inter Cooland	Kesici Uç Uyumluluğu / Insert Suitability		FİYAT PRICE
			WDA XDPT 1104		EURO
ST XDPT 11 001 WDA	✓	✓	EM90 D18 W16 L170 Z02 XDPT 1104		99,00 €
ST XDPT 11 002 WDA	✓	✓	EM90 D20 W20 L170 Z03 XDPT 1104		108,33 €
ST XDPT 11 003 WDA	✓	✓	EM90 D25 W25 L170 Z03 XDPT 1104		120,67 €
ST XDPT 11 004 WDA	✓	✓	EM90 D22 W20 L170 Z03 XDPT 1104		114,33 €
ST XDPT 11 005 WDA	✓	✓	EM90 D40 W32 L170 Z05 XDPT 1104		157,67 €
ST XDPT 11 007 WDA	✓	✓	EM90 D45 W25 L120 Z04 XDPT 1104		129,67 €

XNGU 1002 WDA



KOD	Stok Stock	Inter Cooland	Kesici Uç Uyumluluğu / Insert Suitability		FİYAT PRICE
			WDA XNGU 1002		EURO
ST XNGU 10 001 WDA	✓	✓	EM90 D16 W16 L150 Z02 XNGU 1002		92,67 €
ST XNGU 10 002 WDA	✓	✓	EM90 D20 W20 L150 Z02 XNGU 1002		99,00 €
ST XNGU 10 003 WDA	✓	✓	EM90 D25 W25 L150 Z03 XNGU 1002		108,33 €

BOMT 09T308 INGRSL



KOD	Stok Stock	Inter Cooland	Kesici Uç Uyumluluğu / Insert Suitability		FIYAT PRICE
			INGRSL BOMT 09T308		EURO
ST BOMT 09 001 INGRSL	✓	✗	EM90 D16 W16 L150 Z02 BOMT 09T308		99,00 €
ST BOMT 09 002 INGRSL	✓	✗	EM90 D18 W16 L150 Z02 BOMT 09T308		102,00 €
ST BOMT 09 003 INGRSL	✓	✗	EM90 D20 W20 L150 Z03 BOMT 09T308		111,33 €
ST BOMT 09 004 INGRSL	✓	✗	EM90 D22 W20 L150 Z03 BOMT 09T308		117,67 €

BOMT 1304 INGRSL



KOD	Stok Stock	Inter Cooland	Kesici Uç Uyumluluğu / Insert Suitability		FIYAT PRICE
			INGRSL BOMT 1304		EURO
ST BOMT 13 001 INGRSL	✓	✗	EM90 D20 W20 L150 Z02 BOMT 1304		99,00 €
ST BOMT 13 002 INGRSL	✓	✗	EM90 D22 W20 L150 Z02 BOMT 1304		102,00 €
ST BOMT 13 003 INGRSL	✓	✗	EM90 D25 W25 L150 Z03 BOMT 1304		111,33 €
ST BOMT 13 004 INGRSL	✓	✗	EM90 D32 W25 L150 Z04 BOMT 1304		117,67 €
ST BOMT 13 005 INGRSL	✓	✗	EM90 D32 W32 L150 Z04 BOMT 1304		117,67 €

AOMT 1605 INGRSL



KOD	Stok Stock	Inter Cooland	Kesici Uç Uyumluluğu / Insert Suitability		FIYAT PRICE
			INGRSL AOMT 1605		EURO
ST AOMT 16 001 INGRSL	✓	✗	EM90 D25 W25 L120 Z02 AOMT 1605		111,33 €
ST AOMT 16 002 INGRSL	✓	✗	EM90 D25 W25 L150 Z02 AOMT 1605		114,33 €
ST AOMT 16 003 INGRSL	✓	✗	EM90 D25 W25 L200 Z02 AOMT 1605		126,67 €
ST AOMT 16 004 INGRSL	✓	✗	EM90 D32 W25 L150 Z03 AOMT 1605		129,67 €
ST AOMT 16 005 INGRSL	✓	✗	EM90 D32 W32 L150 Z03 AOMT 1605		129,67 €

TOMT 0603/1004 TNGLY



KOD	Stok Stock	Inter Cooland	Kesici Uç Uyumluluğu / Insert Suitability		FIYAT PRICE
			TNGLY TOMT 0603/1004		EURO
ST TOMT 06 001 TNG	✓	✓	EM90 D16 W16 L150 Z02 TOMT 0603		126,67 €
ST TOMT 06 003 TNG	✓	✓	EM90 D20 W20 L150 Z03 TOMT 0603		136,00 €

BDMT 0703 KYCR



KOD	Stok Stock	Inter Cooland	Kesici Uç Uyumluluğu / Insert Suitability		FIYAT PRICE
			KYCR BDMT-0703		EURO
ST BDMT 07 001 KYCR	✓	X	EM90 D10 W10 L100 Z01 BDMT 0703		102,00 €
ST BDMT 07 002 KYCR	✓	X	EM90 D11 W10 L120 Z02 BDMT 0703		102,00 €
ST BDMT 07 003 KYCR	✓	X	EM90 D12 W11 L120 Z02 BDMT 0703		102,00 €
ST BDMT 07 004 KYCR	✓	X	EM90 D12 W12 L120 Z02 BDMT 0703		102,00 €
ST BDMT 07 005 KYCR	✓	X	EM90 D16 W16 L120 Z03 BDMT 0703		102,00 €
ST BDMT 07 006 KYCR	✓	X	EM90 D14 W12 L120 Z03 BDMT 0703		102,00 €

BDMT 1704 KYCR



KOD	Stok Stock	Inter Cooland	Kesici Uç Uyumluluğu / Insert Suitability		FIYAT PRICE
			KYCR BDMT 1704		EURO
ST BDMT 17 001 KYCR	✓	✓	EM90 D25 W25 L160 Z02 BDMT 1704		112,33 €
ST BDMT 17 003 KYCR	✓	✓	EM90 D32 W32 L200 Z03 BDMT 1704		136,00 €

APKT 1003 KYCR



BDMT 11T3 KYCR



LOMU 1505 KYCR



KOD	Stok Stock	Inter Cooland	Kesici Uç Uyumluluğu / Insert Suitability	FİYAT PRICE
			KYCR APKT 1003	EURO
ST APKT 10 001 KYCR	✓	✓	EM90 D17 W16 L160 Z02 APKT 1003	102,00 €
ST APKT 10 002 KYCR	✓	✓	EM90 D21 W20 L160 Z03 APKT 1003	108,33 €
ST APKT 10 003 KYCR	✓	✓	EM90 D25 W25 L160 Z03 APKT 1003	114,33 €

KOD	Stok Stock	Inter Cooland	Kesici Uç Uyumluluğu / Insert Suitability	FİYAT PRICE
			KYCR BDMT-11T3	EURO
ST BDMT 11 001 KYCR	✓	✓	EM90 D16 W16 L160 Z02 BDMT 11T3	99,00 €
ST BDMT 11 002 KYCR	✓	✓	EM90 D16 W16 L180 Z02 BDMT 11T3	102,00 €
ST BDMT 11 004 KYCR	✓	✓	EM90 D17 W16 L160 Z02 BDMT 11T3	99,00 €
ST BDMT 11 005 KYCR	✓	✓	EM90 D17 W16 L200 Z02 BDMT 11T3	108,33 €
ST BDMT 11 006 KYCR	✓	X	EM90 D17 W16 L260 Z02 BDMT 11T3	120,67 €
ST BDMT 11 007 KYCR	✓	✓	EM90 D20 W20 L110 Z03 BDMT 11T3	98,33 €
ST BDMT 11 008 KYCR	✓	✓	EM90 D20 W20 L160 Z03 BDMT 11T3	108,33 €
ST BDMT 11 009 KYCR	✓	✓	EM90 D20 W20 L180 Z03 BDMT 11T3	111,33 €
ST BDMT 11 010 KYCR	✓	✓	EM90 D20 W20 L200 Z03 BDMT 11T3	117,67 €
ST BDMT 11 011 KYCR	✓	✓	EM90 D21 W20 L160 Z03 BDMT 11T3	108,33 €
ST BDMT 11 012 KYCR	✓	✓	EM90 D21 W20 L180 Z03 BDMT 11T3	111,33 €
ST BDMT 11 013 KYCR	✓	✓	EM90 D21 W20 L200 Z03 BDMT 11T3	117,67 €
ST BDMT 11 014 KYCR	✓	X	EM90 D21 W20 L260 Z03 BDMT 11T3	136,00 €
ST BDMT 11 015 KYCR	✓	✓	EM90 D25 W25 L160 Z03 BDMT 11T3	120,67 €
ST BDMT 11 016 KYCR	✓	✓	EM90 D25 W25 L200 Z03 BDMT 11T3	123,00 €
ST BDMT 11 017 KYCR	✓	✓	EM90 D26 W25 L160 Z03 BDMT 11T3	120,67 €
ST BDMT 11 018 KYCR	✓	✓	EM90 D26 W25 L200 Z03 BDMT 11T3	132,67 €
ST BDMT 11 019 KYCR	✓	X	EM90 D26 W25 L260 Z03 BDMT 11T3	132,67 €
ST BDMT 11 021 KYCR	✓	✓	EM90 D32 W32 L200 Z04 BDMT 11T3	160,67 €
ST BDMT 11 024 KYCR	✓	✓	EM90 D33 W32 L200 Z04 BDMT 11T3	160,67 €
ST BDMT 11 026 KYCR	✓	✓	EM90 D16 W15 L160 Z02 BDMT 11T3	99,00 €
ST BDMT 11 027 KYCR	✓	✓	EM90 D18 W16 L160 Z02 BDMT 11T3	108,33 €
ST BDMT 11 030 KYCR	✓	✓	EM90 D20 W20 L120 Z03 BDMT 11T3	102,00 €
ST BDMT 11 031 KYCR	✓	✓	EM90 D33 W32 L150 Z04 BDMT 11T3	142,00 €

KOD	Stok Stock	Inter Cooland	Kesici Uç Uyumluluğu / Insert Suitability	FİYAT PRICE
			KYCR LOMU-1505	EURO
ST LOMU 15 008 KYCR	✓	✓	EM90 D28 W25 L160 Z02 LOMU 1505	136,00 €
ST LOMU 15 009 KYCR	✓	✓	EM90 D32 W25 L160 Z03 LOMU 1505	160,67 €
ST LOMU 15 010 KYCR	✓	✓	EM90 D32 W32 L160 Z03 LOMU 1505	182,33 €

WNUMU 0504 KYCR



LOMU 1004 KYCR



SOMT 1004 KYCR



KOD	Stok Stock	Inter Cooland	Kesici Uç Uyumluluğu / Insert Suitability	FİYAT PRICE
			KYCR WNUMU 0504	EURO
ST WNUMU 05 001 KYCR	✓	✓	EM90 D22 W20 L160 Z02 WNUMU 0504	105,33 €
ST WNUMU 05 002 KYCR	✓	✓	EM90 D25 W25 L120 Z02 WNUMU 0504	105,33 €
ST WNUMU 05 003 KYCR	✓	✓	EM90 D25 W25 L160 Z02 WNUMU 0504	114,33 €
ST WNUMU 05 004 KYCR	✓	✓	EM90 D26 W25 L160 Z02 WNUMU 0504	114,33 €
ST WNUMU 05 006 KYCR	✓	✓	EM90 D32 W32 L160 Z03 WNUMU 0504	123,33 €
ST WNUMU 05 007 KYCR	✓	✓	EM90 D32 W32 L200 Z03 WNUMU 0504	136,00 €
ST WNUMU 05 010 KYCR	✓	✓	EM90 D30 W25 L120 Z03 WNUMU 0504	117,67 €
ST WNUMU 08 002 KYCR	✓	✓	EM90 D40 W20 L100 Z03 WNUMU 0806	99,00 €
ST WNUMU 08 003 KYCR	✗	✓	EM90 D40 W32 L160 Z03 WNUMU 0806	114,33 €
ST WNUMU 08 004 KYCR	✓	✓	EM90 D40 W32 L150 Z03 WNUMU 0806	114,33 €

KOD	Stok Stock	Inter Cooland	Kesici Uç Uyumluluğu / Insert Suitability	FİYAT PRICE
			KYCR LOMU-1004	EURO
ST LOMU 10 001 KYCR	✓	✓	EM90 D16 W16 L100 Z02 LOMU 1004	102,00 €
ST LOMU 10 002 KYCR	✓	✓	EM90 D16 W16 L160 Z02 LOMU 1004	114,33 €
ST LOMU 10 003 KYCR	✓	✓	EM90 D17 W16 L160 Z02 LOMU 1004	114,33 €
ST LOMU 10 005 KYCR	✓	✓	EM90 D20 W20 L150 Z02 LOMU 1004	123,33 €
ST LOMU 10 007 KYCR	✓	✓	EM90 D21 W20 L160 Z03 LOMU 1004	126,67 €
ST LOMU 10 010 KYCR	✓	✓	EM90 D16 W16 L150 Z02 LOMU 1004	111,33 €
ST LOMU 10 012 KYCR	✓	✓	EM90 D20 W20 L110 Z03 LOMU 1004	120,67 €
ST LOMU 10 013 KYCR	✓	✓	EM90 D20 W20 L160 Z03 LOMU 1004	123,33 €
ST LOMU 10 014 KYCR	✓	✓	EM90 D26 W25 L160 Z03 LOMU 1004	148,33 €
ST LOMU 10 015 KYCR	✓	✓	EM90 D25 W25 L160 Z03 LOMU 1004	148,33 €
ST LOMU 10 016 KYCR	✓	✓	EM90 D25 W25 L200 Z03 LOMU 1004	151,33 €
ST LOMU 10 017 KYCR	✓	✓	EM90 D28 W25 L160 Z04 LOMU 1004	151,33 €
ST LOMU 10 019 KYCR	✓	✓	EM90 D21 W20 L200 Z03 LOMU 1004	137,00 €

KOD	Stok Stock	Inter Cooland	Kesici Uç Uyumluluğu / Insert Suitability	FİYAT PRICE
			KYCR SOMT 1004	EURO
ST SOMT 10 001 KYCR	✓	✓	BMR D25 W25 L160 Z02 SOMT 1004	111,33 €
ST SOMT 10 002 KYCR	✓	✓	BMR D26 W25 L160 Z02 SOMT 1004	120,67 €
ST SOMT 10 003 KYCR	✓	✓	BMR D33 W32 L160 Z03 SOMT 1004	129,67 €

XDKT 11T3 CRTZT



APKT 1604 BHLR



SDMT 06/09 ZCC



KOD	Stok Stock	Inter Cooland	Kesici Uç Uyumluluğu / Insert Suitability		FİYAT PRICE
			CRTZ XDKT 11T3		EURO
ST XDKT 11T 001 CRTZ	✓	✗	EM90 D16 W15 L150 Z02 XDKT 11T3		99,00 €
ST XDKT 11T 002 CRTZ	✓	✗	EM90 D20 W19 L150 Z03 XDKT 11T3		102,00 €
ST XDKT 11T 003 CRTZ	✓	✗	EM90 D25 W24 L150 Z03 XDKT 11T3		108,33 €
ST XDKT 11T 004 CRTZ	✓	✗	EM90 D32 W25 L150 Z04 XDKT 11T3		120,67 €

KOD	Stok Stock	Inter Cooland	Kesici Uç Uyumluluğu / Insert Suitability		FİYAT PRICE
			BHLR APKT 1604		EURO
ST APKT 16 001 BHLR	✓	✗	EM90 D25 W25 L150 Z02 APKT 1604		111,33 €
ST APKT 16 002 BHLR	✓	✗	EM90 D32 W32 L150 Z03 APKT 1604		117,67 €

KOD	Stok Stock	Inter Cooland	Kesici Uç Uyumluluğu / Insert Suitability		FİYAT PRICE
			ZCC SDMT 06/09		EURO
ST SDMT 06 002 ZCC	✓	✓	BMR D16 W16 L150 Z02 SDMT 06T2		102,00 €
ST SDMT 06 003 ZCC	✓	✓	BMR D17 W16 L160 Z02 SDMT 06T2		102,00 €
ST SDMT 06 004 ZCC	✓	✓	BMR D20 W20 L160 Z03 SDMT 06T2		108,33 €
ST SDMT 06 005 ZCC	✓	✓	BMR D20 W20 L150 Z02 SDMT 06T2		105,33 €
ST SDMT 06 006 ZCC	✓	✓	BMR D20 W20 L150 Z03 SDMT 06T2		108,33 €
ST SDMT 06 007 ZCC	✓	✓	BMR D21 W20 L200 Z03 SDMT 06T2		120,67 €
ST SDMT 09 002 ZCC	✓	✓	BMR D22 W20 L170 Z02 SDMT 09T3		108,33 €
ST SDMT 09 005 ZCC	✓	✓	BMR D25 W25 L160 Z02 SDMT 09T3		108,33 €
ST SDMT 09 006 ZCC	✓	✓	BMR D26 W25 L200 Z02 SDMT 09T3		120,67 €
ST SDMT 09 007 ZCC	✓	✓	BMR D32 W25 L150 Z03 SDMT 09T3		129,67 €
ST SDMT 09 008 ZCC	✓	✓	BMR D32 W32 L150 Z03 SDMT 09T3		129,67 €
ST SDMT 09 009 ZCC	✓	✓	BMR D32 W32 L160 Z03 SDMT 09T3		129,67 €
ST SDMT 09 011 ZCC	✓	✓	BMR D33 W32 L200 Z04 SDMT 09T3		136,00 €
ST SDMT 09 012 ZCC	✓	✓	BMR D42 W32 L160 Z04 SDMT 09T3		154,33 €
ST SDMT 09 013 ZCC	✓	✓	BMR D33 W32 L160 Z03 SDMT 09T3		129,67 €
ST SDMT 09 014 ZCC	✓	✓	BMR D32 W32 L200 Z03 SDMT 09T3		136,00 €
ST SDMT 09 015 ZCC	✓	✓	BMR D25 W25 L200 Z02 SDMT 09T3		120,67 €
ST SDMT 09 016 ZCC	✓	✓	BMR D25 W25 L160 Z03 SDMT 09T3		117,67 €
ST SDMT 09 019 ZCC	✓	✓	BMR D26 W25 L160 Z02 SDMT 09T3		108,33 €
ST SDMT 09 020 ZCC	✓	✓	BMR D26 W25 L160 Z03 SDMT 09T3		99,00 €
ST SDMT 09 021 ZCC	✓	✓	BMR D26 W25 L200 Z03 SDMT 09T3		136,00 €
ST SDMT 09 022 ZCC	✓	✓	BMR D33 W32 L250 Z03 SDMT 09T3		146,67 €
ST SDMT 09 023 ZCC	✓	✓	BMR D35 W32 L160 Z04 SDMT 09T3		136,00 €
ST SDMT 09 024 ZCC	✓	✓	BMR D25 W25 L200 Z03 SDMT 09T3		120,67 €

WPGT 0503 ZCC



KOD	Stok Stock	Inter Cooland	Kesici Uç Uyumluluğu / Insert Suitability		FIYAT PRICE
			WPGT 0503 ZCC		EURO
ST WPGT 05 001 ZCC	✓	✓	BMR D21 W20 L170 Z02 WPGT 0503		123,33 €
ST WPGT 05 002 ZCC	✓	✓	BMR D26 W25 L200 Z03 WPGT 0503		136,00 €

SP..08T3 PLBT



KOD	Stok Stock	Inter Cooland	Kesici Uç Uyumluluğu / Insert Suitability		FIYAT PRICE
			PLBT SP..08T3/09T3		EURO
ST SPKT 08 001 PLBT	X	X	BMR D20 W20 L150 Z02 SPKT 08T3		111,33 €
ST SPKT 08 002 PLBT	X	X	BMR D25 W25 L150 Z03 SPKT 08T3		111,33 €

SDMX 09T308 PLBT



KOD	Stok Stock	Inter Cooland	Kesici Uç Uyumluluğu / Insert Suitability		FIYAT PRICE
			PLBT SDMX 09T308		EURO
ST SDMX 09 002 PLBT	✓	✓	BMR D25 W25 L150 Z03 SDMX 09T3		114,33 €
ST SDMX 09 003 PLBT	✓	✓	BMR D32 W32 L150 Z04 SDMX 09T3		129,67 €

BLMP 0603 TT



LPGT 0102 KYCR



LOGU 0303 KYCR



KOD	Stok Stock	Inter Cooland	Kesici Uç Uyumluluğu / Insert Suitability		FİYAT PRICE
			TT BLM. 0603		EURO
ST BLMP 06 001 TT	✓	✓	BMR D16 W15 L150 Z02	BLMP 0603	108,33 €
ST BLMP 06 002 TT	✓	✓	BMR D16 W16 L150 Z02	BLMP 0603	108,33 €
ST BLMP 06 003 TT	✓	✓	BMR D17 W16 L150 Z02	BLMP 0603	111,33 €
ST BLMP 06 004 TT	✓	✓	BMR D17 W16 L200 Z02	BLMP 0603	123,33 €
ST BLMP 06 005 TT	✓	✓	BMR D21 W20 L150 Z03	BLMP 0603	114,33 €
ST BLMP 06 006 TT	✓	✓	BMR D21 W20 L200 Z03	BLMP 0603	126,67 €
ST BLMP 06 007 TT	✓	✓	BMR D26 W25 L150 Z04	BLMP 0603	142,00 €
ST BLMP 06 008 TT	✓	✓	BMR D26 W25 L200 Z04	BLMP 0603	160,67 €
ST BLMP 06 009 TT	✓	✓	BMR D25 W25 L150 Z04	BLMP 0603	139,00 €
ST BLMP 06 010 TT	✓	✓	BMR D20 W20 L150 Z03	BLMP 0603	114,33 €
ST BLMP 06 011 TT	✓	✓	BMR D32 W32 L200 Z05	BLMP 0603	166,67 €
ST BLMP 06 012 TT	✓	✓	BMR D33 W32 L200 Z05	BLMP 0603	166,67 €
ST BLMP 06 013 TT	✓	✓	BMR D17 W16 L100 Z02	BLMP 0603	102,00 €

KOD	Stok Stock	Inter Cooland	Kesici Uç Uyumluluğu / Insert Suitability		FİYAT PRICE
			KYCR LPGT 0102		EURO
ST LPGT 01 001 KYCR	✓	X	BMR D9 W10 L75 Z01	LPGT 010210	99,00 €
ST LPGT 01 002 KYCR	✓	X	BMR D10 W10 L100 Z02	LPGT 0102	102,00 €
ST LPGT 01 003 KYCR	✓	X	BMR D11 W10 L120 Z02	LPGT 0102	108,33 €
ST LPGT 01 004 KYCR	✓	X	BMR D12 W11 L120 Z02	LPGT 0102	111,33 €
ST LPGT 01 005 KYCR	✓	X	BMR D12 W11 L120 Z03	LPGT 0102	114,33 €
ST LPGT 01 006 KYCR	✓	X	BMR D12 W12 L120 Z02	LPGT 0102	111,33 €
ST LPGT 01 007 KYCR	✓	X	BMR D12 W12 L150 Z03	LPGT 0102	120,67 €
ST LPGT 01 010 KYCR	✓	X	BMR D16 W16 L160 Z04	LPGT 0102	136,00 €
ST LPGT 01 011 KYCR	✓	X	BMR D12 W12 L100 Z02	LPGT 0102	105,33 €
ST LPGT 01 012 KYCR	✓	X	BMR D12 W12 L120 Z03	LPGT 0102	114,33 €
ST LPGT 01 013 KYCR	✓	X	BMR D14 W14 L120 Z03	LPGT 0102	117,67 €
ST LPGT 01 014 KYCR	✓	X	BMR D10 W09 L120 Z02	LPGT 0102	105,33 €

KOD	Stok Stock	Inter Cooland	Kesici Uç Uyumluluğu / Insert Suitability		FİYAT PRICE
			KYCR LOGU 0303		EURO
ST LOGU 03 002 KYCR	✓	✓	BMR D16 W16 L160 Z02	LOGU 0303	114,33 €
ST LOGU 03 003 KYCR	✓	✓	BMR D16 W16 L200 Z02	LOGU 0303	123,33 €
ST LOGU 03 004 KYCR	✓	✓	BMR D17 W16 L160 Z02	LOGU 0303	114,33 €
ST LOGU 03 005 KYCR	✓	✓	BMR D17 W16 L200 Z02	LOGU 0303	123,33 €
ST LOGU 03 006 KYCR	✓	✓	BMR D18 W16 L160 Z02	LOGU 0303	117,67 €
ST LOGU 03 007 KYCR	✓	✓	BMR D20 W20 L130 Z03	LOGU 0303	114,33 €
ST LOGU 03 008 KYCR	✓	✓	BMR D20 W20 L160 Z03	LOGU 0303	123,33 €
ST LOGU 03 010 KYCR	✓	✓	BMR D21 W20 L160 Z03	LOGU 0303	123,33 €
ST LOGU 03 012 KYCR	✓	✓	BMR D22 W20 L160 Z03	LOGU 0303	123,33 €
ST LOGU 03 013 KYCR	✓	✓	BMR D25 W25 L160 Z04	LOGU 0303	148,33 €
ST LOGU 03 014 KYCR	✓	✓	BMR D25 W25 L180 Z04	LOGU 0303	154,33 €
ST LOGU 03 016 KYCR	✓	✓	BMR D26 W25 L160 Z04	LOGU 0303	151,33 €
ST LOGU 03 020 KYCR	✓	✓	BMR D32 W32 L160 Z05	LOGU 0303	157,67 €
ST LOGU 03 021 KYCR	✓	✓	BMR D32 W32 L200 Z05	LOGU 0303	173,00 €
ST LOGU 03 022 KYCR	✓	✓	BMR D33 W32 L160 Z05	LOGU 0303	157,67 €
ST LOGU 03 024 KYCR	✓	✓	BMR D28 W25 L160 Z04	LOGU 0303	154,33 €
ST LOGU 03 025 KYCR	✓	✓	BMR D16 W15 L160 Z02	LOGU 0303	114,33 €
ST LOGU 03 026 KYCR	✓	✓	BMR D20 W20 L200 Z03	LOGU 0303	131,67 €
ST LOGU 03 027 KYCR	✓	✓	BMR D20 W20 L110 Z03	LOGU 0303	114,33 €
ST LOGU 03 029 KYCR	✓	✓	BMR D26 W25 L200 Z04	LOGU 0303	163,67 €
ST LOGU 03 030 KYCR	✓	X	BMR D26 W25 L250 Z04	LOGU 0303	176,00 €
ST LOGU 03 031 KYCR	✓	✓	BMR D16 W16 L110 Z02	LOGU 0303	105,33 €
ST LOGU 03 032 KYCR	✓	✓	BMR D21 W20 L200 Z03	LOGU 0303	138,33 €
ST LOGU 03 033 KYCR	✓	✓	BMR D28 W25 L200 Z04	LOGU 0303	163,67 €

SOMT 12T3 MTSBHS



KOD	Stok Stock	Inter Cooland	Kesici Uç Uyumluluğu / Insert Suitability	FİYAT PRICE
			MTSBHS SOMT 12T3	EURO
ST SOMT 12 001 MTSBHS	✓	✓	BMR D32 W32 L150 Z02 SOMT 12T3	129,67 €
ST SOMT 12 002 MTSBHS	✓	✓	BMR D40 W32 L150 Z03 SOMT 12T3	145,33 €

P26335 R10/R14 WLTR



KOD	Stok Stock	Inter Cooland	Kesici Uç Uyumluluğu / Insert Suitability	FİYAT PRICE
			WLTR P26335 -R10-R14	EURO
ST P2633 R 10 002 WLTR	✓	✓	BMR D25 W25 L150 Z03 P26335R-10	117,67 €
ST P2633 R 10 003 WLTR	✓	✓	BMR D26 W25 L200 Z03 P26335R-10	136,00 €
ST P2633 R 10 004 WLTR	✓	✓	BMR D32 W32 L150 Z04 P26335R-10	142,00 €
ST P2633 R 14 001 WLTR	✓	✓	BMR D32 W32 L150 Z03 P26335R-14	142,00 €

WNMX 09T3 KRLY



KOD	Stok Stock	Inter Cooland	Kesici Uç Uyumluluğu / Insert Suitability	FİYAT PRICE
			KRLY WNMX 09T3	EURO
ST WNMX 09 003 KRLY	✓	✓	BMR D25 W25 L150 Z02 WNMX 09T3	111,33 €
ST WNMX 09 004 KRLY	✓	✓	BMR D32 W32 L150 Z03 WNMX 09T3	132,67 €

WNMX 0603 KRLY



KOD	Stok Stock	Inter Cooland	Kesici Uç Uyumluluğu / Insert Suitability		FIYAT PRICE
			KRLY WNMX 0603		EURO
ST WNMX 06 001 KRLY	✓	✓	BMR D16 W16 L150 Z02 WNMX 0603		102,00 €
ST WNMX 06 002 KRLY	✓	✓	BMR D20 W20 L150 Z03 WNMX 0603		111,33 €
ST WNMX 06 003 KRLY	✓	✓	BMR D17 W16 L150 Z02 WNMX 0603		102,00 €
ST WNMX 06 004 KRLY	✓	✓	BMR D21 W20 L150 Z03 WNMX 0603		111,33 €

LPMW 0402 KRLY



KOD	Stok Stock	Inter Cooland	Kesici Uç Uyumluluğu / Insert Suitability		FIYAT PRICE
			KRLY LPMW 0402		EURO
ST LPMW 0402 001 KRLY	✓	X	BMR D10 W10 L120 Z02 LPMW 0402		126,67 €
ST LPMW 0402 002 KRLY	✓	X	BMR D12 W12 L120 Z03 LPMW 0402		132,67 €
ST LPMW 0402 004 KRLY	✓	X	BMR D16 W16 L150 Z04 LPMW 0402		148,34 €
ST LPMW 0402 003 KRLY	✓	X	BMR D16 W16 L120 Z04 LPMW 0402		139,00 €
ST LPMW 0402 005 KRLY	✓	X	BMR D14 W12 L120 Z03 LPMW 0402		136,00 €

LNMX 060310 KRLY



KOD	Stok Stock	Inter Cooland	Kesici Uç Uyumluluğu / Insert Suitability		FIYAT PRICE
			KRLY LNMX 0603		EURO
ST LNMX 06 001 KRLY	✓	✓	BMR D16 W16 L130 Z02 LNMX 0603		108,33 €
ST LNMX 06 002 KRLY	✓	✓	BMR D20 W20 L150 Z03 LNMX 0603		120,67 €
ST LNMX 06 003 KRLY	✓	✓	BMR D25 W25 L160 Z04 LNMX 0603		132,67 €
ST LNMX 06 005 KRLY	✓	✓	BMR D17 W16 L200 Z02 LNMX 0603		123,33 €
ST LNMX 06 006 KRLY	✓	✓	BMR D16 W16 L150 Z02 LNMX 0603		108,33 €
ST LNMX 06 007 KRLY	✓	✓	BMR D20 W20 L250 Z03 LNMX 0603		136,00 €
ST LNMX 06 008 KRLY	✓	✓	BMR D21 W20 L150 Z03 LNMX 0603		120,67 €
ST LNMX 06 009 KRLY	✓	✓	BMR D25 W25 L150 Z04 LNMX 0603		132,67 €
ST LNMX 06 010 KRLY	✓	✓	BMR D25 W25 L250 Z04 LNMX 0603		148,33 €
ST LNMX 06 011 KRLY	✓	✓	BMR D32 W32 L150 Z05 LNMX 0603		154,33 €
ST LNMX 06 013 KRLY	✓	✓	BMR D40 W32 L150 Z06 LNMX 0603		166,67 €

SDMT 1004 BHLR



KOD	Stok Stock	Inter Cooland	Kesici Uç Uyumluluğu / Insert Suitability		FİYAT PRICE
			BHLR SDMT 1004		EURO
ST SDMT 10 003 BHLR	✓	✓	BMR D32 W32 L150 Z03 SDMT 1004		136,00 €
ST SDMT 10 005 BHLR	✓	✓	BMR D33 W32 L200 Z03 SDMT 1004		151,33 €

ZDCW 09T3 PRMT



KOD	Stok Stock	Inter Cooland	Kesici Uç Uyumluluğu / Insert Suitability		FİYAT PRICE
			PRMT ZDCW 09T3		EURO
ST ZDCW 09 002 PRMT	✓	✓	BMR D25 W25 L150 Z02 ZDCW 09T3		123,33 €
ST ZDCW 09 003 PRMT	✓	✓	BMR D32 W32 L150 Z03 ZDCW 09T3		142,00 €

LNMU 0303 TNGLY



KOD	Stok Stock	Inter Cooland	Kesici Uç Uyumluluğu / Insert Suitability		FİYAT PRICE
			TNGLY LNMU 0303		EURO
ST LNMU 03 001 TNG	✓	✓	BMR D16 W16 L160 Z02 LNMU 0303		120,67 €
ST LNMU 03 002 TNG	✓	✓	BMR D18 W16 L150 Z02 LNMU 0303		123,33 €
ST LNMU 03 003 TNG	✓	✓	BMR D20 W20 L160 Z03 LNMU 0303		132,67 €
ST LNMU 03 004 TNG	✓	✓	BMR D21 W20 L160 Z03 LNMU 0303		132,67 €
ST LNMU 03 006 TNG	✓	✓	BMR D25 W25 L160 Z04 LNMU 0303		160,67 €
ST LNMU 03 007 TNG	✓	✓	BMR D32 W32 L160 Z04 LNMU 0303		173,00 €
ST LNMU 03 008 TNG	✓	✓	BMR D21 W20 L200 Z03 LNMU 0303		142,00 €
ST LNMU 03 009 TNG	✓	✓	BMR D25 W25 L200 Z04 LNMU 0303		170,00 €
ST LNMU 03 010 TNG	✓	✓	BMR D26 W25 L160 Z04 LNMU 0303		160,67 €
ST LNMU 03 011 TNG	✓	✓	BMR D32 W32 L200 Z04 LNMU 0303		182,33 €
ST LNMU 03 012 TNG	✓	✓	BMR D33 W32 L200 Z04 LNMU 0303		182,33 €
ST LNMU 03 013 TNG	✓	✓	BMR D26 W25 L250 Z04 LNMU 0303		179,00 €
ST LNMU 03 014 TNG	✓	X	BMR D26 W25 L200 Z04 LNMU 0303		170,00 €
ST LNMU 03 015 TNG	✓	✓	BMR D20 W20 L200 Z03 LNMU 0303		148,33 €
ST LNMU 03 016 TNG	✓	✓	BMR D22 W20 L160 Z03 LNMU 0303		132,67 €
ST LNMU 03 017 TNG	✓	✓	BMR D17 W16 L160 Z02 LNMU 0303		120,67 €
ST LNMU 03 018 TNG	✓	✓	BMR D17 W16 L200 Z02 LNMU 0303		132,67 €
ST LNMU 03 019 TNG	✓	✓	BMR D33 W32 L160 Z05 LNMU 0303		174,00 €
ST LNMU 03 020 TNG	✓	✓	BMR D16 W16 L200 Z02 LNMU 0303		132,67 €
ST LNMU 03 021 TNG	✓	✓	BMR D16 W16 L250 Z02 LNMU 0303		142,33 €

XPPT 070308 WDA



KOD	Stok Stock	Inter Cooland	Kesici Uç Uyumluluğu / Insert Suitability	FİYAT PRICE
			WDA XPPT 0703	EURO
ST XPPT 07 001 WDA	✓	✓	BMR D16 W16 L170 Z02 XPPT 0703	99,00 €
ST XPPT 07 002 WDA	✓	✓	BMR D20 W20 L170 Z02 XPPT 0703	105,33 €
ST XPPT 07 007 WDA	✓	✓	BMR D20 W20 L170 Z03 XPPT 0703	110,00 €

SOMW 0803 SNG



KOD	Stok Stock	Inter Cooland	Kesici Uç Uyumluluğu / Insert Suitability	FİYAT PRICE
			SNG SOMW 0803	EURO
ST SOMW 08 002 SNG	✓	✓	BMR D20 W20 L160 Z02 SOMW 0803	102,00 €
ST SOMW 08 003 SNG	✓	✓	BMR D25 W25 L160 Z03 SOMW 0803	114,33 €
ST SOMW 08 004 SNG	✓	✓	BMR D32 W32 L160 Z04 SOMW 0803	145,33 €
ST SOMW 08 005 SNG	✓	✓	BMR D26 W25 L200 Z03 SOMW 0803	120,67 €
ST SOMW 08 006 SNG	✓	✓	BMR D20 W20 L200 Z02 SOMW 0803	110,00 €
ST SOMW 08 007 SNG	✓	✓	BMR D25 W25 L200 Z03 SOMW 0803	125,33 €
ST SOMW 08 008 SNG	✓	✓	BMR D32 W32 L200 Z04 SOMW 0803	157,67 €

YNGX 0603 SNG



KOD	Stok Stock	Inter Cooland	Kesici Uç Uyumluluğu / Insert Suitability	FİYAT PRICE
			SNG YNGX 0603	EURO
ST YNGX 06 001 SNG	✗	✓	EM90 D16 W16 L160 Z02 YNGX 0603	111,33 €
ST YNGX 06 002 SNG	✗	✓	EM90 D17 W16 L160 Z02 YNGX 0603	111,33 €
ST YNGX 06 003 SNG	✗	✓	EM90 D20 W20 L160 Z03 YNGX 0603	126,67 €
ST YNGX 06 005 SNG	✗	✓	EM90 D25 W25 L160 Z03 YNGX 0603	136,00 €
ST YNGX 06 006 SNG	✗	✓	EM90 D26 W25 L160 Z03 YNGX 0603	136,00 €

SPMW 1204 SNG



KOD	Stok Stock	Inter Cooland	Kesici Uç Uyumluluğu / Insert Suitability	FIYAT PRICE
			SNG SPMW 1204	EURO
ST SPMW 12 001 SNG	✓	✓	BMR D32 W32 L160 Z02 SPMW 1204	120,67 €

XPW. 0603 VNDRT



KOD	Stok Stock	Inter Cooland	Kesici Uç Uyumluluğu / Insert Suitability	FIYAT PRICE
			VNDRT XPW.0603TN	EURO
ST XPW 06 002 VNDRT	✓	✓	BMR D17 W16 L150 Z02 XPW. 0603TN	105,33 €
ST XPW 06 004 VNDRT	✓	✓	BMR D21 W20 L150 Z03 XPW. 0603TN	117,67 €

XDHW 060210 PLB / VNDRT



KOD	Stok Stock	Inter Cooland	Kesici Uç Uyumluluğu / Insert Suitability	FIYAT PRICE
			PLB / VNDRT XDHW 060210	EURO
ST XDHW 06 001 PLB/VND	✓	✓	BMR D16 W16 L150 Z02 XDHW 0602	114,33 €
ST XDHW 06 002 PLB/VND	✓	✓	BMR D17 W16 L150 Z02 XDHW 0602	114,33 €
ST XDHW 06 003 PLB/VND	✓	✓	BMR D20 W20 L150 Z03 XDHW 0602	117,67 €
ST XDHW 06 004 PLB/VND	✓	✓	BMR D25 W25 L150 Z04 XDHW 0602	123,33 €

ENMX 08T3 WLTR

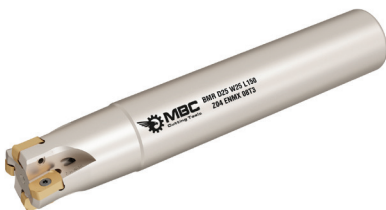

KOD	Stok Stock	Inter Cooland	Kesici Uç Uyumluluğu / Insert Suitability	FIYAT PRICE
			WLTR ENMX 08T3	EURO
ST ENMX 08 001 WLTR	✓	✓	BMR D16 W16 L150 Z02 ENMX 08T3	117,67 €
ST ENMX 08 003 WLTR	✓	✓	BMR D16 W16 L200 Z02 ENMX 08T3	129,67 €
ST ENMX 08 004 WLTR	✓	✓	BMR D20 W20 L150 Z03 ENMX 08T3	129,67 €
ST ENMX 08 006 WLTR	✓	✓	BMR D25 W25 L150 Z04 ENMX 08T3	154,33 €

WDKT 08 ISO



KOD	Stok Stock	Inter Cooland	Kesici Uç Uyumluluğu / Insert Suitability		FİYAT PRICE
			ISO WDKT 08		EURO
ST WDKT 08 002 ISO	✓	✗	BMR D25 W25 L150 Z02 WDKT 08		102,00 €
ST WDKT 08 003 ISO	✓	✗	BMR D30 W32 L150 Z02 WDKT 08		117,67 €
ST WDKT 08 004 ISO	✓	✗	BMR D32 W32 L150 Z03 WDKT 08		120,67 €

RD..05/07/08/10/12 ISO



KOD	Stok Stock	Inter Cooland	Kesici Uç Uyumluluğu / Insert Suitability		FİYAT PRICE
			ISO RD.. 05/07/08/10/12		EURO
ST RD..05 001 ISO	✓	✗	EMR D10 W10 L100 Z02 RD..0501		68,00 €
ST RD..05 003 ISO	✓	✗	EMR D12 W12 L100 Z02 RD..0501		68,00 €
ST RD..08 007 ISO	✓	✓	EMR D16 W16 L120 Z02 RD..0803		68,00 €
ST RD..08 008 ISO	✓	✓	EMR D16 W16 L150 Z02 RD..0803		89,67 €
ST RD..08 011 ISO	✓	✓	EMR D20 W20 L150 Z03 RD..0802		96,00 €
ST RD..10 009 ISO	✓	✓	EMR D32 W32 L200 Z03 RD..1003		136,00 €
ST RD..10 012 ISO	✓	✓	EMR D20 W20 L120 Z02 RD..1003		77,33 €
ST RD..10 013 ISO	✓	✓	EMR D20 W20 L150 Z02 RD..1003		89,67 €
ST RD..10 014 ISO	✓	✓	EMR D20 W20 L200 Z02 RD..1003		108,33 €
ST RD..10 015 ISO	✓	✓	EMR D25 W25 L150 Z02 RD..1003		99,00 €
ST RD..10 016 ISO	✓	✓	EMR D25 W25 L200 Z02 RD..1003		111,33 €
ST RD..10 017 ISO	✓	✓	EMR D32 W32 L150 Z03 RD..1003		108,33 €
ST RD..10 019 ISO	✓	✗	EMR D32 W32 L250 Z03 RD..1003		126,67 €
ST RD..10 020 ISO	✓	✓	EMR D40 W32 L150 Z04 RD..1003		129,67 €
ST RD..10 021 ISO	✓	✗	EMR D40 W32 L250 Z02 RD..1003		136,00 €
ST RD..10 022 ISO	✓	✗	EMR D40 W32 L250 Z04 RD..1003		142,00 €
ST RD..10 023 ISO	✓	✓	EMR D20 W20 L150 Z02 RD..10T3		89,67 €
ST RD..10 024 ISO	✓	✓	EMR D25 W25 L150 Z02 RD..10T3		102,00 €
ST RD..10 025 ISO	✓	✓	EMR D25 W25 L200 Z02 RD..10T3		114,33 €
ST RD..10 029 ISO	✓	✓	EMR D40 W32 L150 Z04 RD..10T3		136,00 €
ST RD..10 030 ISO	✓	✓	EMR D40 W32 L250 Z02 RD..10T3		151,33 €
ST RD..10 031 ISO	✓	✗	EMR D40 W32 L250 Z04 RD..10T3		160,67 €
ST RD..10 032 ISO	✓	✗	EMR D32 W32 L160 Z03 RD..10T3		108,33 €
ST RD..12 032 ISO	✓	✓	EMR D25 W25 L150 Z02 RD..1204		105,33 €
ST RD..12 033 ISO	✓	✓	EMR D32 W25 L150 Z03 RD..1204		108,33 €
ST RD..12 034 ISO	✓	✓	EMR D32 W32 L150 Z03 RD..1204		108,33 €
ST RD..12 035 ISO	✓	✓	EMR D40 W25 L150 Z04 RD..1204		129,67 €
ST RD..12 036 ISO	✓	✓	EMR D40 W32 L150 Z04 RD..1204		129,67 €
ST RD..12 037 ISO	✓	✓	EMR D32 W25 L200 Z03 RD..1204		120,67 €
ST RD..12 038 ISO	✓	✓	EMR D32 W32 L200 Z03 RD..1204		129,67 €
ST RD..12 039 ISO	✓	✓	EMR D25 W25 L200 Z02 RD..1204		114,33 €

RPMW 1003 ISO



KOD	Stok Stock	Inter Cooland	Kesici Uç Uyumluluğu / Insert Suitability	FİYAT PRICE
			ISO RPMW 1003	EURO
ST RPMW 10 001 ISO	✓	✓	EMR D20 W20 L150 Z02 RPMW 1003	99,00 €
ST RPMW 10 002 ISO	✓	✓	EMR D25 W25 L150 Z02 RPMW 1003	105,33 €

RPMT 1204 TNGLY



KOD	Stok Stock	Inter Cooland	Kesici Uç Uyumluluğu / Insert Suitability	FİYAT PRICE
			TNGLY RPMT 1204	EURO
ST RPMT 12 001 TNG	✓	✓	EMR D25 W25 L160 Z02 RPMT 1204	108,33 €
ST RPMT 12 002 TNG	✓	✓	EMR D30 W25 L160 Z03 RPMT 1204	117,67 €
ST RPMT 12 003 TNG	✓	✓	EMR D32 W32 L160 Z03 RPMT 1204	117,67 €

RPMT 10T3 TNGLY



KOD	Stok Stock	Inter Cooland	Kesici Uç Uyumluluğu / Insert Suitability	FİYAT PRICE
			TNGLY RPMT 10T3	EURO
ST RPMT 10T3 001 TNG	✓	✓	EMR D20 W20 L160 Z02 RPMT 10T3	102,00 €
ST RPMT 10T3 003 TNG	✓	✓	EMR D25 W25 L160 Z02 RPMT 10T3	108,33 €
ST RPMT 10T3 004 TNG	✓	✓	EMR D30 W25 L160 Z03 RPMT 10T3	117,67 €
ST RPMT 10T3 005 TNG	✓	✓	EMR D32 W32 L160 Z03 RPMT 10T3	117,67 €

RDMX 0802 SNG



KOD	Stok Stock	Inter Cooland	Kesici Uç Uyumluluğu / Insert Suitability	FİYAT PRICE
			SNG RDMX 0802	EURO
ST RDMX 08 001 SNG	✓	✓	EMR D16 W16 L160 Z02 RDMX 0802	86,67 €
ST RDMX 08 002 SNG	✓	✓	EMR D20 W20 L160 Z02 RDMX 0802	92,67 €

B.ST



KOD	Stok Stock	Inter Cooland	Kesici Uç Uyumluluğu / Insert Suitability		FIYAT PRICE
			HRN B.ST		EURO
A05.0016.07.B.ST HRN	✓	✓	A05.0016.07.B.ST		86,67 €
A07.0020.07.B.ST HRN	✓	✓	A07.0020.07.B.ST		86,67 €
A08.0020.09.B.ST HRN	✓	✓	A08.0020.09.B.ST		86,67 €
A09.0025.07.B.ST HRN	✓	✓	A09.0025.07.B.ST		86,67 €

HD 12



KOD	Stok Stock	Inter Cooland	Kesici Uç Uyumluluğu / Insert Suitability		FIYAT PRICE
			ISO		EURO
HD 12 06 R 001 HRN	✓	X	HD 12-6 R		74,33 €
HD 12 07 R 002 HRN	✓	X	HD 12-7 R		74,33 €
HD 12 08 R 003 HRN	✓	X	HD 12-8 R		74,33 €
HD 12 09 R 004 HRN	✓	X	HD 12-9 R		74,33 €
HD 12 11 R 005 HRN	✓	X	HD 12-11 R		74,33 €

DİŞ TARAĞI



KOD	Stok / Stock	Kesici Uç Uyumluluğu / Insert Suitability		FIYAT PRICE
		DİŞ TARAĞI CPT - C14 - C21		EURO
DT C14 001	✓	DT D16 W16 L120 CPT C14		120,67 €
DT C21 002	✓	DT D18 W20 L100 CPT C21		120,67 €
DT C21 003	✓	DT D21 W25 L120 CPT C21		123,33 €
DT C21 004	✓	DT D25 W25 L120 CPT C21		123,33 €

VİDALI TAKIM TUTUCU



KOD	Stok Stock	Inter Cooland	Kesici Uç Uyumluluğu / Insert Suitability		FIYAT PRICE
			VİDALI UZATMA		EURO
VTU M12 001	✓	✓	VTU D25 M12 L120		132,67 €
VTU M12 002	✓	✓	VTU D25 M12 L160		142,00 €
VTU M12 003	✓	✓	VTU D25 M12 L200		182,33 €
VTU M16 004	✓	✓	VTU D32 M16 L120		132,67 €
VTU M16 005	✓	✓	VTU D32 M16 L160		151,33 €
VTU M16 006	✓	✓	VTU D32 M16 L200		200,67 €
VTU M16 007	✓	✓	VTU D32 M16 L250		242,33 €



HIGH FEED FINISH TAKIMLARI
HIGH FEED FINISH TOOLS

**KÜRE 08/10/12/16
20/25/30/32 WLTR**



KOD	Stok / Stock	Kesici Uç Uyumluluğu / Insert Suitability	FİYAT PRICE
		WLTR P3201/P3204	EURO
ST P3201 002 WLTR	✓	BMR D10 W12 L130 P3201-D10	99,00 €
ST P3204 003 WLTR	✓	BMR D12 W12 L130 P3204-D12	105,33 €
ST P3204 004 WLTR	✓	BMR D16 W16 L140 P3204-D16	108,33 €
ST P3204 005 WLTR	✓	BMR D20 W20 L160 P3204-D20	129,67 €
ST P3201 006 WLTR	✓	BMR D25 W25 L160 P3201-D25	129,67 €

ROHX 12/16/20 ZCC



KOD	Stok / Stock	Kesici Uç Uyumluluğu / Insert Suitability	FİYAT PRICE
		ZCC ROHX 12/16/20	EURO
ST ROHX 16 002 ZCC	✓	BMR D16 W16 L160 ROHX 1604	108,33 €
ST ROHX 16 003 ZCC	✓	BMR D16 W16 L200 ROHX 1604	114,33 €
ST ROHX 16 004 ZCC	✓	BMR D16 W16 L250 ROHX 1604	132,67 €
ST ROHX 20 005 ZCC	✓	BMR D20 W20 L160 ROHX 2005	120,67 €
ST ROHX 20 006 ZCC	✓	BMR D20 W20 L200 RDHX 2005	129,67 €
ST ROHX 20 008 ZCC	✓	BMR D20 W25 L240 ROHX 2005	139,00 €

**ZOHX 12/16/20
25/32 ZCC**



KOD	Stok / Stock	Kesici Uç Uyumluluğu / Insert Suitability	FİYAT PRICE
		ZCC ZOHX 12/16/20/25/32	EURO
ST ZOHX 16 002 ZCC	✓	BMR D16 W16 L180 ZOHX 1604	108,33 €
ST ZOHX 20 003 ZCC	✓	BMR D20 W20 L200 ZOHX 2005	120,67 €
ST ZOHX 25 004 ZCC	✓	BMR D25 W25 L250 ZOHX 2506	129,67 €
ST ZOHX 32 005 ZCC	✗	BMR D32 W32 L250 ZOHX 3207	176,00 €



FREZELEME TAKIMLARI FACE MILLING

**CCMT 06/09/12
ISO DISK FREZE**

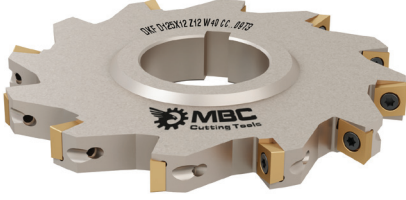

KOD	Stok / Stock	Kesici Uç Uyumluluğu / Insert Suitability		FIYAT PRICE
		ISO CCMT 06/09/12		EURO
DKF 001 ISO	✓	DKF D80X8 Z10 W27 CC..0602		222,33 €
DKF 002 ISO	✓	DKF D100X8 Z12 W32 CC..0602		253,00 €
DKF 003 ISO	✓	DKF D125X8 Z14 W40 CC..0602		308,67 €
DKF 004 ISO	✓	DKF D160X8 Z16 W40 CC..0602		370,33 €
DKF 005 ISO	✓	DKF D80X10 Z10 W27 CC..0602		222,33 €
DKF 006 ISO	✓	DKF D100X10 Z12 W32 CC..0602		253,00 €
DKF 007 ISO	✓	DKF D125X10 Z14 W40 CC..0602		308,67 €
DKF 008 ISO	✓	DKF D160X10 Z16 W40 CC..0602		370,33 €
DKF 009 ISO	✓	DKF D80X12 Z08 W27 CC..09T3		222,33 €
DKF 010 ISO	✓	DKF D100X12 Z10 W32 CC..09T3		253,00 €
DKF 011 ISO	✓	DKF D125X12 Z12 W40 CC..09T3		308,67 €
DKF 012 ISO	✓	DKF D160X12 Z14 W40 CC..09T3		370,33 €
DKF 013 ISO	✓	DKF D80X14 Z08 W27 CC..09T3		222,33 €
DKF 014 ISO	✓	DKF D100X14 Z10 W32 CC..09T3		253,00 €
DKF 015 ISO	✓	DKF D125X14 Z12 W40 CC..09T3		308,67 €
DKF 016 ISO	✓	DKF D160X14 Z14 W40 CC..09T3		370,33 €
DKF 017 ISO	✓	DKF D80X16 Z06 W27 CC..1204		222,33 €
DKF 018 ISO	✓	DKF D100X16 Z08 W32 CC..1204		253,00 €
DKF 019 ISO	✓	DKF D125X16 Z10 W40 CC..1204		308,67 €
DKF 020 ISO	✓	DKF D160X16 Z12 W40 CC..1204		370,33 €

**APKT 1003 ISO
HELİSEL FREZE**



KOD	Stok Stock	Inter Cooland	Kesici Uç Uyumluluğu / Insert Suitability		FIYAT PRICE
			ISO APKT 1003		EURO
S HF AP.. 10 001 ISO	✓	✓	HF90 D20 W20 L110 Z 2X3 AP..10		247,00 €
S HF AP.. 10 002 ISO	✓	✓	HF90 D25 W25 L120 Z 2X4 AP..10		305,67 €
S HF AP.. 10 003 ISO	✓	✓	HF90 D32 W32 L120 Z 3X5 AP..10		401,33 €
S HF AP.. 10 004 ISO	✓	✓	HF90 D40 W32 L130 Z 3X6 AP..10		432,00 €

LNKT 1206 ZCC

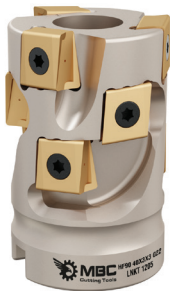

KOD	Stok Stock	Inter Cooland	Kesici Uç Uyumluluğu / Insert Suitability		FIYAT PRICE
			ZCC LNKT 1206		EURO
TK HF LNKT 12 002 ZCC	✓	✓	HF90 50X4X4 027 LNKT 1206		555,67 €
TK HF LNKT 12 003 ZCC	✓	✓	HF90 50X4X4 022 LNKT 1206		555,67 €

**AP.. 1604 ISO
HELİSEL FREZE**



KOD	Stok Stock	Inter Cooland	Kesici Uç Uyumluluğu / Insert Suitability		FIYAT PRICE
			ISO AP.. 1604		EURO
TK HF 001 ISO	✓	✗	HF90 50X3X4 AP..16		524,67 €
TK HF 002 ISO	✓	✗	HF90 63X4X4 AP..16		586,33 €
TK HF 003 ISO	✓	✗	HF90 80X5X5 AP..16		648,00 €

**TCMT 11/16 ISO
HAVŞA MATKABI**



KOD	Stok Stock	Inter Cooland	Kesici Uç Uyumluluğu / Insert Suitability		FIYAT PRICE
			ISO TCMT 11/16		EURO
HM 001 ISO	✓	✗	HM45 D4-15 W16 L100 Z01 TC..11		58,67 €
HM 002 ISO	✓	✗	HM45 D14-25 W25 L100 Z02 TC..11		58,67 €
HM 003 ISO	✓	✗	HM45 D16-30 W12 L100 Z03 TC..11		58,67 €
HM 004 ISO	✓	✗	HM45 D21-35 W12 L100 Z03 TC..11		65,00 €
HM 005 ISO	✓	✗	HM45 D5-23 W16 L100 Z01 TC..16		60,33 €
HM 006 ISO	✓	✗	HM45 D10-31 W16 L100 Z02 TC..16		60,33 €
HM 007 ISO	✓	✗	HM45 D14-35 W20 L100 Z02 TC..16		60,33 €
HM 009 ISO	✓	✗	HM45 D22-43 W25 L100 Z03 TC..16		66,33 €
HM 010 ISO	✓	✗	HM45 D30-50 W25 L100 Z03 TC..16		96,00 €
HM 012 ISO	✓	✗	HM60 D6-20 W16 L100 Z01 TC..16		54,33 €
HM 013 ISO	✓	✗	HM60 D20-35 W20 L100 Z02 TC..16		58,67 €
HM 014 ISO	✓	✗	HM60 D24-40 W25 L100 Z02 TC..16		96,00 €

**CCMT 06/09 ISO
T FREZE**



KOD	Stok Stock	Inter Cooland	Kesici Uç Uyumluluğu / Insert Suitability		FIYAT PRICE
			ISO CCMT 06/09		EURO
TF 000 ISO	X	X	TF90 D14X7 W16 Z02 SR.050204		92,67 €
TF 002 ISO	X	X	TF90 D20X9 W16 Z02 CCMT 06		99,00 €
TF 003 ISO	✓	X	TF90 D21X9 W16 Z02 CCMT 06		99,00 €
TF 004 ISO	✓	X	TF90 D24X10 W20 Z02 CCMT 06		105,33 €
TF 005 ISO	✓	X	TF90 D25X11 W25 Z02 CCMT 06		105,33 €
TF 006 ISO	✓	X	TF90 D25X12 W25 Z02 CCMT 06		105,33 €
TF 007 ISO	✓	X	TF90 D32X8 W25 Z04 CCMT 06		136,00 €
TF 008 ISO	✓	X	TF90 D32X10 W25 Z04 CCMT 06		136,00 €
TF 009 ISO	✓	X	TF90 D63X8 W32 Z08 CCMT 06		231,67 €
TF 010 ISO	✓	X	TF90 D30X12 W25 Z02 CCMT 09		136,00 €
TF 011 ISO	✓	X	TF90 D32X14 W25 Z02 CCMT 09		136,00 €
TF 012 ISO	✓	X	TF90 D40X16 W32 Z04 CCMT 09		145,33 €
TF 013 ISO	✓	X	TF90 D40X18 W32 Z04 CCMT 09		154,33 €
TF 014 ISO	✓	X	TF90 D32X12 W25 Z02 CCMT 09		136,00 €
TF 015 ISO	✓	X	TF90 D40X12 W32 Z04 CCMT 09		145,33 €
TF 016 ISO	✓	X	TF90 D50X12 W32 Z04 CCMT 09		182,33 €
TF 017 ISO	✓	X	TF90 D50X16 W32 Z04 CCMT 09		185,33 €
TF 018 ISO	✓	X	TF90 D42X8 W25 Z04 CCMT 0602		145,33 €
TF 019 (L) ISO	✓	X	TF90 D32X8,5 W20 Z04 CCMT 06 (L)		123,33 €
TF 020 (R) ISO	✓	X	TF90 D32X8,5 W20 Z04 CCMT 06 (R)		123,33 €
TF 022 ISO	✓	X	TF90 D17X9 W16 Z02 CCMT 0602		99,00 €

**DCMT 11 55° ISO
KIRLANGIÇ FREZE**

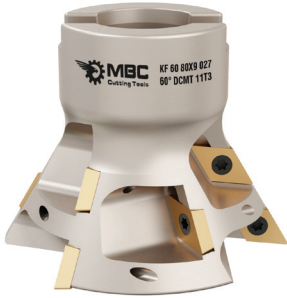

KOD	Stok Stock	Inter Cooland	Kesici Uç Uyumluluğu / Insert Suitability		FIYAT PRICE
			ISO		EURO
TK KRF 55 001 ISO	✓	X	KF 55 80X9 027 55° DCMT 11T3		555,67 €
TK KRF 60 002 ISO	✓	X	KF 60 80X9 027 60° DCMT 11T3		555,67 €
TK KRF 55 003 ISO	✓	X	KF 55 50X4 022 60° DCMT 11T3		386,00 €



TARAMA KAFALARI FACE MILLING

90° TPKN 16 ISO

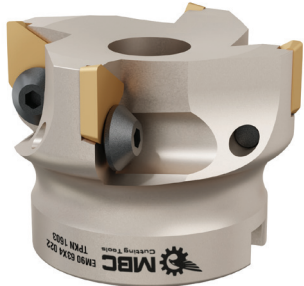

KOD	Stok Stock	Inter Cooland	Kesici Uç Uyumluluğu / Insert Suitability	FIYAT PRICE
			ISO TPKN 1603	EURO
TK TPKN 16 001 ISO	✓	✗	EM90 50X3 022 TPKN 1603	92,67 €
TK TPKN 16 002 ISO	✓	✗	EM90 63X4 022 TPKN 1603	111,33 €
TK TPKN 16 003 ISO	✓	✗	EM90 80X5 032 TPKN 1603	132,67 €
TK TPKN 16 004 ISO	✓	✗	EM90 100X6 032 TPKN 1603	148,33 €

90° TPKN 22 ISO

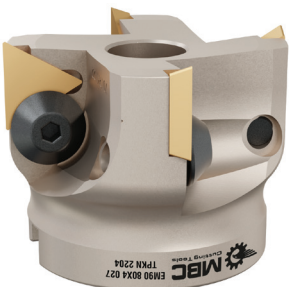

KOD	Stok Stock	Inter Cooland	Kesici Uç Uyumluluğu / Insert Suitability	FIYAT PRICE
			ISO TP.. 2204	EURO
TK TPKN 22 001 ISO	✓	✗	EM90 63X3 022 TPKN 2204	111,33 €
TK TPKN 22 002 ISO	✓	✗	EM90 80X4 027 TPKN 2204	136,00 €
TK TPKN 22 003 ISO	✓	✗	EM90 80X4 032 TPKN 2204	136,00 €
TK TPKN 22 004 ISO	✓	✗	EM90 100X5 032 TPKN 2204	166,67 €
TK TPKN 22 005 ISO	✓	✗	EM90 125X6 032 TPKN 2204	251,00 €
TK TPKN 22 006 ISO	✓	✗	EM90 125X6 040 TPKN 2204	251,00 €
TK TPKN 22 007 ISO	✓	✗	EM90 160X7 040 TPKN 2204	293,33 €
TK TPKN 22 008 ISO	✓	✗	EM90 200X8 060 TPKN 2204	500,00 €
TK TPKN 22 009 ISO	✓	✗	EM90 250X10 060 TPKN 2204	691,33 €

90° AP.. 1003 ISO



KOD	Stok Stock	Inter Cooland	Kesici Uç Uyumluluğu / Insert Suitability	FIYAT PRICE
			ISO AP.. 1003	EURO
TK AP..10 001 ISO	✓	✗	EM90 40X5 016 APKT 1003	77,33 €
TK AP..10 001 ISO (S)	✓	✓	EM90 40X5 016 APKT 1003 inter cooland	89,67 €
TK AP..10 002 ISO	✓	✗	EM90 50X6 022 APKT 1003	102,00 €
TK AP..10 002 ISO (S)	✓	✓	EM90 50X6 022 APKT 1003 inter cooland	111,33 €
TK AP..10 003 ISO	✓	✗	EM90 63X7 022 APKT 1003	117,67 €
TK AP..10 003 ISO (S)	✓	✓	EM90 63X7 022 APKT 1003 inter cooland	126,67 €
TK AP..10 004 ISO	✓	✗	EM90 80X8 027 APKT 1003	136,00 €
TK AP..10 004 ISO (S)	✓	✓	EM90 80X8 027 APKT 1003 inter cooland	148,33 €
TK AP..10 005 ISO	✓	✗	EM90 100X9 032 APKT 1003	160,67 €
TK AP..10 005 ISO (S)	✓	✓	EM90 100X9 032 APKT 1003 inter cooland	176,00 €

90° APKT 16 ISO

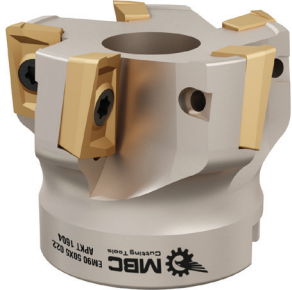

90° VCGT 2205 ISO

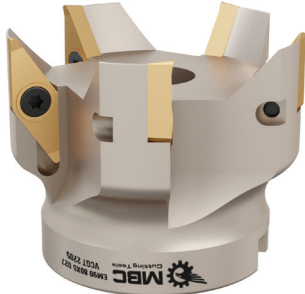

90° TPKT 2205 DRCP

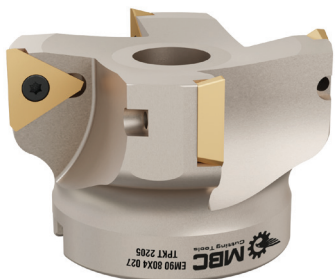

KOD	Stok Stock	Inter Cooland	Kesici Uç Uyumluluğu / Insert Suitability		FIYAT PRICE
			ISO APKT 1604		EURO
TK AP..16 001 ISO	✓	X	EM90 40X4 016 APKT 1604		77,33 €
TK AP..16 001 ISO (S)	✓	✓	EM90 40X4 016 APKT 1604 inter cooland		86,67 €
TK AP..16 002 ISO	✓	X	EM90 50X4 022 APK T1604		99,00 €
TK AP..16 002 ISO (S)	✓	✓	EM90 50X4 022 APKT 1604 inter cooland		105,33 €
TK AP..16 003 ISO	✓	X	EM90 50X5 022 APKT 1604		99,00 €
TK AP..16 003 ISO (S)	✓	✓	EM90 50X5 022 APKT 1604 inter cooland		105,33 €
TK AP..16 004 ISO	✓	X	EM90 63X5 022 APKT 1604		114,33 €
TK AP..16 004 ISO (S)	✓	✓	EM90 63X5 022 APKT 1604 inter cooland		120,67 €
TK AP..16 005 ISO	✓	X	EM90 80X6 027 APKT 1604		139,00 €
TK AP..16 005 ISO (S)	✓	✓	EM90 80X6 027 APKT 1604 inter cooland		139,00 €
TK AP..16 006 ISO	✓	X	EM90 80X6 032 APKT 1604		139,00 €
TK AP..16 006 ISO (S)	✓	✓	EM90 80X6 032 APKT 1604 inter cooland		139,00 €
TK AP..16 007 ISO	✓	X	EM90 80X7 027 APKT 1604		139,00 €
TK AP..16 008 ISO	✓	X	EM90 100X8 032 APKT 1604		160,67 €
TK AP..16 008 ISO (S)	✓	✓	EM90 100X8 032 APKT 1604 inter cooland		170,00 €
TK AP..16 011 ISO	✓	X	EM90 125X9 040 APKT 1604		253,00 €
TK AP..16 012 ISO	✓	X	EM90 160X10 040 APKT 1604		308,67 €
TK AP..16 013 ISO	✓	X	EM90 200X12 060 APKT 1604		524,67 €
TK AP..16 014 ISO	✓	X	EM90 250X14 060 APKT 1604		709,67 €

KOD	Stok Stock	Inter Cooland	Kesici Uç Uyumluluğu / Insert Suitability		FIYAT PRICE
			ISO VCGT 2205		EURO
TK VCGT 22 001 ISO	✓	✓	EM90 50X3 022 VCGT 2205		102,00 €
TK VCGT 22 002 ISO	✓	✓	EM90 63X4 022 VCGT 2205		139,00 €
TK VCGT 22 004 ISO	✓	✓	EM90 80X5 027 VCGT 2205		151,33 €

KOD	Stok Stock	Inter Cooland	Kesici Uç Uyumluluğu / Insert Suitability		FIYAT PRICE
			DRCP TPKT 2205		EURO
TK TPKT 22 001 DRCP	✓	X	EM90 63X3 022 TPKT 2205		129,67 €
TK TPKT 22 002 DRCP	✓	X	EM90 80X4 027 TPKT 2205		163,67 €
TK TPKT 22 003 DRCP	✓	X	EM90 100X5 032 TPKT 2205		191,67 €
TK TPKT 22 004 DRCP	✓	X	EM90 125X6 040 TPKT 2205		268,67 €

90° ANKX 09 I



KOD	Stok Stock	Inter Cooland	Kesici Uç Uyumluluğu / Insert Suitability	FİYAT PRICE
			I ANKX 09	EURO
TK ANKX 09 002 ISO (S)	✓	✓	EM90 50X7 022 ANKX 09 inter cooland	123,33 €

90° AN.. 1205 I

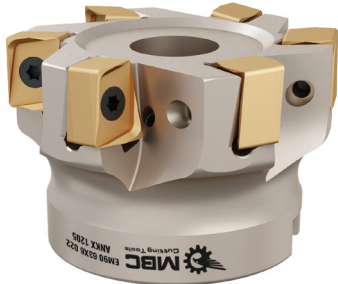

KOD	Stok Stock	Inter Cooland	Kesici Uç Uyumluluğu / Insert Suitability	FİYAT PRICE
			I ANKX 1205	EURO
TK ANKX 12 001 I	✓	✓	EM90 50X5 022 ANKX 1205	108,00 €
TK ANKX 12 002 I	✓	✓	EM90 63X6 022 ANKX 1205	119,67 €
TK ANKX 12 003 I	✓	✓	EM90 80X7 027 ANKX 1205	152,33 €
TK ANKX 12 004 I	✓	✓	EM90 100X8 032 ANKX 1205	190,00 €
TK ANKX 12 005 I	✓	X	EM90 125X10 040 ANKX 1205	256,33 €

90° TP.. 1003 I



KOD	Stok Stock	Inter Cooland	Kesici Uç Uyumluluğu / Insert Suitability	FİYAT PRICE
			I TPKT 1003	EURO
TK TPKT 10 001 I	✓	✓	EM90 40X5 016 TPKT 1003	139,00 €
TK TPKT 10 002 I	✓	✓	EM90 50X6 022 TPKT 1003	166,67 €
TK TPKT 10 003 I	✓	✓	EM90 63X7 022 TPKT 1003	182,33 €

90° TD.. 1505 I



KOD	Stok Stock	Inter Cooland	Kesici Uç Uyumluluğu / Insert Suitability	FIYAT PRICE
			I TD.. 1505	EURO
TK TD.. 15 001 I	✓	✗	EM90 50X4 022 TD.. 1505	129,67 €
TK TD.. 15 002 I	✓	✗	EM90 63X5 022 TD.. 1505	151,34 €

90° AD.. 1505 I



KOD	Stok Stock	Inter Cooland	Kesici Uç Uyumluluğu / Insert Suitability	FIYAT PRICE
			I AD.. 15	EURO
TK AD.. 15 001 I	✓	✓	EM90 40X4 016 AD.. 15	102,00 €
TK AD.. 15 002 I	✓	✓	EM90 50X5 022 AD.. 15	122,00 €
TK AD.. 15 003 I	✓	✓	EM90 63X6 022 AD.. 15	141,00 €
TK AD.. 15 004 I	✓	✓	EM90 80X7 027 AD.. 15	182,00 €
TK AD.. 15 005 I	✓	✓	EM90 100X8 032 AD.. 15	210,00 €

90° LN.. 0804 I



KOD	Stok Stock	Inter Cooland	Kesici Uç Uyumluluğu / Insert Suitability	FIYAT PRICE
			I LN.. 0804	EURO
TK LN.. 08 001 I	✓	✓	EM90 50X5 022 LN..0804	108,33 €
TK LN.. 08 002 I	✓	✓	EM90 63X7 022 LN.. 0804	129,67 €

90° LNGX 1307 WLTR



KOD	Stok Stock	Inter Cooland	Kesici Uç Uyumluluğu / Insert Suitability	FIYAT PRICE
			WLTR LNGX 1307	EURO
TK LNGX 13 004 WLTR	✓	✓	EM90 100X8 032 LNGX 1307	210,00 €
TK LNGX 13 006 WLTR	✓	✗	EM90 160X8 040 LNGX 1307	370,33 €
TK LNGX 13 007 WLTR	✓	✓	EM90 80X7 027 LNGX 1307	160,67 €
TK LNGX 13 008 WLTR	✓	✓	EM90 50X4 022 LNGX 1307	114,33 €
TK LNGX 13 009 WLTR	✓	✓	EM90 63X5 022 LNGX 1307	129,67 €
TK LNGX 13 010 WLTR	✓	✗	EM90 125X10 040 LNGX 1307	278,00 €

90° LNHU 1306 WLTR



KOD	Stok Stock	Inter Cooland	Kesici Uç Uyumluluğu / Insert Suitability	FIYAT PRICE
			WLTR LNHU 1306	EURO
TK LNHU 13 001 WLTR	✓	✓	EM90 40X4 016 LNHU 1306	114,33 €
TK LNHU 13 002 WLTR	✓	✓	EM90 50X5 022 LNHU 1306	142,00 €
TK LNHU 13 003 WLTR	✓	✓	EM90 63X6 022 LNHU 1306	151,33 €
TK LNHU 13 004 WLTR	✓	✓	EM90 80X7 027 LNHU 1306	182,33 €
TK LNHU 13 005 WLTR	✓	✓	EM90 100X9 032 LNHU 1306	213,00 €

90° ADMT 1204 WLTR



KOD	Stok Stock	Inter Cooland	Kesici Uç Uyumluluğu / Insert Suitability	FIYAT PRICE
			WLTR ADMT 1204	EURO
TK ADMT 12 001 WLTR	✓	✗	EM90 40X4 016 ADMT 1204	120,67 €
TK ADMT 12 002 WLTR	✓	✗	EM90 50X5 022 ADMT 1204	142,00 €
TK ADMT 12 003 WLTR	✓	✗	EM90 63X6 022 ADMT 1204	160,67 €

90° P2840 WLTR



KOD	Stok Stock	Inter Cooland	Kesici Uç Uyumluluğu / Insert Suitability	FIYAT PRICE
			WLTR P2840	EURO
TK P2840 63 001 WLTR	✓	✓	EM90 40X4 016 P-2840	92,67 €
TK P2840 63 002 WLTR	✓	✓	EM90 50X5 022 P-2840	108,33 €

90° SPMT 1204 WLTR

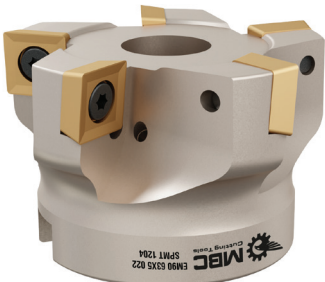

KOD	Stok Stock	Inter Cooland	Kesici Uç Uyumluluğu / Insert Suitability	FIYAT PRICE
			WLTR SPMT 1204	EURO
TK SPMT 12 002 ISO	✓	✓	EM90 50X4 022 SPMT 1204	105,33 €
TK SPMT 12 003 ISO	✓	✓	EM90 63X5 022 SPMT 1204	120,67 €

90° LNMX 1006/1510 KRLY



KOD	Stok Stock	Inter Cooland	Kesici Uç Uyumluluğu / Insert Suitability	FIYAT PRICE
			KRLY LNMX 1006/1510	EURO
TK LNMX 10 001 KRLY	✓	✓	EM90 40X4 016 LNMX 1006	92,67 €
TK LNMX 10 002 KRLY	✓	✓	EM90 40X5 016 LNMX 1006	92,67 €
TK LNMX 10 003 KRLY	✓	✓	EM90 50X6 022 LNMX 1006	105,33 €
TK LNMX 15 004 KRLY	✓	✓	EM90 50X4 022 LNMX 1510	111,33 €
TK LNMX 15 005 KRLY	✓	✓	EM90 63X6 022 LNMX 1510	139,00 €
TK LNMX 15 006 KRLY	✓	✓	EM90 80X7 027 LNMX 1510	154,33 €
TK LNMX 15 007 KRLY	✓	✓	EM90 100X8 032 LNMX 1510	185,33 €
TK LNMX 15 008 KRLY	✓	✗	EM90 125X10 040 LNMX 1510	247,00 €
TK LNMX 15 009 KRLY	✓	✗	EM90 160X12 040 LNMX 1510	339,33 €

90° XNKT 0805 KRLY



KOD	Stok Stock	Inter Cooland	Kesici Uç Uyumluluğu / Insert Suitability	FIYAT PRICE
			KRLY XNKT 0805	EURO
TK XNKT 08 001 KRLY	✓	✓	EM90 40X4 016 XNKT 0805	108,33 €
TK XNKT 08 002 KRLY	✓	✓	EM90 50X5 022 XNKT 0805	129,67 €
TK XNKT 08 003 KRLY	✓	✓	EM90 63X6 022 XNKT 0805	151,33 €
TK XNKT 08 004 KRLY	✓	✓	EM90 80X7 027 XNKT 0805	182,33 €
TK XNKT 08 005 KRLY	✓	✓	EM90 100X8 032 XNKT 0805	216,00 €

90° APMT 11T3 KRLY



KOD	Stok Stock	Inter Cooland	Kesici Uç Uyumluluğu / Insert Suitability	FIYAT PRICE
			KRLY APMT 11T3	EURO
TK APMT 11 000 KRLY	✓	✓	EM90 40X5 016 APMT 11T3	114,33 €
TK APMT 11 001 KRLY	✓	✓	EM90 40X6 016 APMT 11T3	114,33 €
TK APMT 11 002 KRLY	✓	✓	EM90 50X6 022 APMT 11T3	142,00 €
TK APMT 11 003 KRLY	✓	✓	EM90 63X7 022 APMT 11T3	154,33 €

90° APMT 1604 KRLY

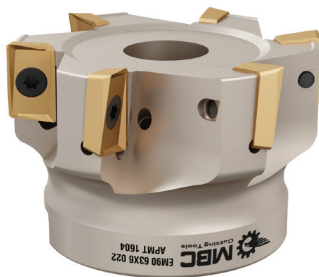

KOD	Stok Stock	Inter Cooland	Kesici Uç Uyumluluğu / Insert Suitability	FIYAT PRICE
			KRLY APMT 1604	EURO
TK APMT 16 001 KRLY	✓	✓	EM90 50X5 022 APMT 1604	117,67 €
TK APMT 16 003 KRLY	✓	✓	EM90 63X6 022 APMT 1604	132,67 €
TK APMT 16 004 KRLY	✓	✓	EM90 80X7 027 APMT 1604	148,33 €
TK APMT 16 005 KRLY	✓	✓	EM90 100X8 032 APMT 1604	179,00 €

90° LNGU 1607 PRMT



KOD	Stok Stock	Inter Cooland	Kesici Uç Uyumluluğu / Insert Suitability	FIYAT PRICE
			PRMT LNGU 1607	EURO
TK LNGU 16 002 PRMT	✓	✓	EM90 80X4 027 LNGU 1607	151,33 €
TK LNGU 16 003 PRMT	✓	✓	EM90 100X5 032 LNGU 1607	170,00 €
TK LNGU 16 004 PRMT			EM90 63X5 022 LNGU 1607	132,67 €

90° ADMX 1606 PRMT



KOD	Stok Stock	Inter Cooland	Kesici Uç Uyumluluğu / Insert Suitability	FIYAT PRICE
			PRMT ADMX 1606	EURO
TK ADMX 16 001 PRMT	✓	X	EM90 50X4 022 ADMX 1606	105,33 €
TK ADMX 16 002 PRMT	✓	X	EM90 50X5 022 ADMX 1606	114,33 €
TK ADMX 16 003 PRMT	✓	X	EM90 80X7 027 ADMX 1606	132,67 €
TK ADMX 16 005 PRMT	✓	X	EM90 100X8 032 ADMX 1606	182,33 €

90° XN..0403 SCO-VNDRT



KOD	Stok Stock	Inter Cooland	Kesici Uç Uyumluluğu / Insert Suitability	FIYAT PRICE
			SCO - VNDR XNEX 0403	EURO
TK XNEX 04 001 SC-VD	✓	✓	EM90 40X6 016 XNEX 0403	142,00 €
TK XNEX 04 002 SC-VD	✓	✓	EM90 50X7 022 XNEX 0403	154,33 €

90° LNGX 1205 VNDRT

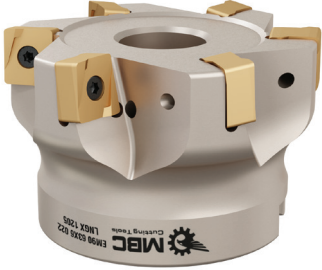

KOD	Stok Stock	Inter Cooland	Kesici Uç Uyumluluğu / Insert Suitability	FİYAT PRICE
			PRMT/VNDRT LNGX 1205	EURO
TK LNGX 12 001 VNDRT	✓	✓	EM90 40X4 016 LNGX 1205	99,00 €
TK LNGX 12 002 VNDRT	✓	✓	EM90 50X5 022 LNGX 1205	114,33 €
TK LNGX 12 003 VNDRT	✓	✓	EM90 63X6 022 LNGX 1205	132,67 €
TK LNGX 12 004 VNDRT	✓	✓	EM90 80X5 032 LNGX 1205	154,33 €

90° ANHG 1005 VNDRT



KOD	Stok Stock	Inter Cooland	Kesici Uç Uyumluluğu / Insert Suitability	FİYAT PRICE
			VNDRT ANHG 1005	EURO
TK ANHG 10 001 VNDRT	✓	✓	EM90 40X4 016 ANHG 1005	117,67 €
TK ANHG 10 002 VNDRT	✓	✓	EM90 50X5 022 ANHG 1005	123,33 €
TK ANHG 10 003 VNDRT	✓	✓	EM90 63X5 022 ANHG 1005	146,67 €
TK ANHG 10 004 VNDRT	✓	✓	EM90 63X7 022 ANHG 1003	154,33 €
TK ANHG 10 006 VNDRT	✓	✓	EM90 100X7 032 ANHG 1005	207,33 €
TK ANHG 10 007 VNDRT	✓	✓	EM90 100X8 032 ANHG 1005	207,33 €

90° XNEX 0806 VNDRT



KOD	Stok Stock	Inter Cooland	Kesici Uç Uyumluluğu / Insert Suitability	FİYAT PRICE
			SCO-VNDR XNEX 0806	EURO
TK XNEX 08 002 SC-VD	✓	✓	EM90 50X4 022 XNEX 0806	132,67 €
TK XNEX 08 003 SC-VD	✓	✓	EM90 63X5 022 XNEX 0806	154,33 €
TK XNEX 08 004 SC-VD	✓	✓	EM90 80X7 027 XNEX 0806	176,00 €
TK XNEX 08 005 SC-VD	✓	✓	EM90 100X8 032 XNEX 0806	216,00 €
TK XNEX 08 006 SC-VD	✓	✗	EM90 160X12 040 XNEX 0806	370,33 €

Lütfen Sipariş vermeden önce stok durumunu sorunuz.
Please ask before ordering, stock status.

L: Sol / Left

R: Sağ / Right

✓ Stokta / In Stock

✗ Stokta Yok / Non Stock

90° ANHG 1607 VNDRT

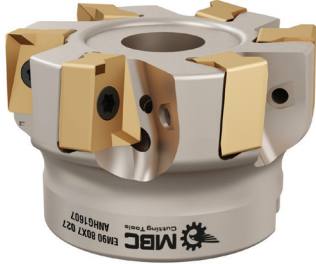

KOD	Stok Stock	Inter Cooland	Kesici Uç Uyumluluğu / Insert Suitability	FIYAT PRICE
			VNDRT ANHG 1607	EURO
TK ANHG 16 001 VNDRT	✓	✓	EM90 50X4 022 ANHG 1607	120,67 €
TK ANHG 16 002 VNDRT	✓	✓	EM90 63X4 022 ANHG 1607	148,33 €
TK ANHG 16 003 VNDRT	✓	✓	EM90 63X6 022 ANHG 1607	148,33 €
TK ANHG 16 004 VNDRT	✓	✓	EM90 80X5 027 ANHG 1607	185,33 €
TK ANHG 16 005 VNDRT	✓	✓	EM90 80X7 027 ANHG 1607	194,33 €
TK ANHG 16 006 VNDRT	✓	✓	EM90 100X8 032 ANHG 1607	211,67 €

90° ANHX 1607 TT



KOD	Stok Stock	Inter Cooland	Kesici Uç Uyumluluğu / Insert Suitability	FIYAT PRICE
			TT ANHX 1607	EURO
TK ANHX 16 001 TT	✓	✓	EM90 50X5 022 ANHX 1607	123,33 €
TK ANHX 16 002 TT	✓	✓	EM90 63X6 022 ANHX 1607	139,00 €
TK ANHX 16 003 TT	✓	✓	EM90 80X7 027 ANHX 1607	183,33 €
TK ANHX 16 004 TT	✓	✓	EM90 100X8 032 ANHX 1607	200,67 €

90° WNMU 0806 SNG

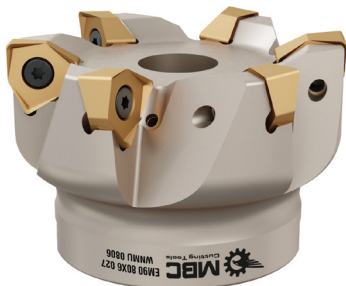

KOD	Stok Stock	Inter Cooland	Kesici Uç Uyumluluğu / Insert Suitability	FIYAT PRICE
			SNG WNMU 0806	EURO
TK WNMU 08 001 SNG	✓	✓	EM90 50X4 022 WNMU 0806	123,33 €
TK WNMU 08 002 SNG	✓	✓	EM90 52X4 022 WNMU 0806	126,67 €
TK WNMU 08 003 SNG	✓	✓	EM90 63X4 022 WNMU 0806	151,33 €
TK WNMU 08 004 SNG	✓	✓	EM90 63X5 022 WNMU 0806	154,33 €
TK WNMU 08 005 SNG	✓	✓	EM90 80X6 027 WNMU 0806	176,00 €
TK WNMU 08 006 SNG	✓	✗	EM90 125X8 040 WNMU 0806	278,00 €
TK WNMU 08 007 SNG	✓	✗	EM90 160X10 040 WNMU 0806	401,33 €
TK WNMU 08 008 SNG	✓	✓	EM90 100X7 032 WNMU 0806	216,00 €

90° APMT 1135 SNG



KOD	Stok Stock	Inter Cooland	Kesici Uç Uyumluluğu / Insert Suitability	FIYAT PRICE
			SNG APMT 1135	EURO
TK APMT 1135 001 SNG	✓	✓	EM90 40X5 016 APMT 1135	111,33 €
TK APMT 1135 003 SNG	✓	✓	EM90 63X7 022 APMT 1135	129,67 €

90° 3PGX 1004 SNG



KOD	Stok Stock	Inter Cooland	Kesici Uç Uyumluluğu / Insert Suitability	FIYAT PRICE
			SNG 3PGX 1004	EURO
TK 3PGX 10 001 SNG	✓	✓	EM90 40X5 016 3PGX 1004	111,33 €
TK 3PGX 10 002 SNG	✓	✓	EM90 50X6 022 3PGX 1004	120,67 €

90° 3PGX 1505 SNG

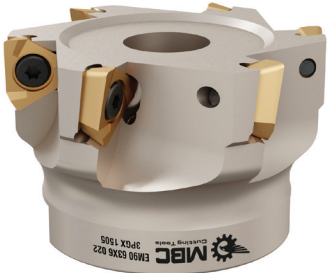

KOD	Stok Stock	Inter Cooland	Kesici Uç Uyumluluğu / Insert Suitability	FIYAT PRICE
			SNG 3PGX 1505	EURO
TK 3PGX 15 001 SNG	✓	✓	EM90 50X5 022 3PGX 1505	117,67 €
TK 3PGX 15 002 SNG	✓	✓	EM90 63X6 022 3PGX 1505	132,67 €
TK 3PGX 15 003 SNG	✓	✓	EM90 80X7 027 3PGX 1505	142,00 €
TK 3PGX 15 005 SNG	✓	✗	EM90 125X10 040 3PGX 1505	271,67 €

Lütfen Sipariş vermeden önce stok durumunu sorunuz.
Please ask before ordering , stock status.

L: Sol / Left

R: Sağ / Right

✓ Stokta / In Stock

✗ Stokta Yok / Non Stock

90° XNMU 0606 SMTM



KOD	Stok Stock	Inter Cooland	Kesici Uç Uyumluluğu / Insert Suitability	FIYAT PRICE
			SMTM XNMU 0606	EURO
TK XNMU 06 002 SMTM	✓	✓	EM90 63X7 022 XNMU 060608	152,67 €
TK XNMU 06 004 SMTM	✓	✓	EM90 80X9 027 XNMU 060608	184,33 €

90° XOMX 1204 SCO

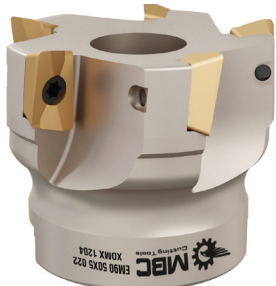

KOD	Stok Stock	Inter Cooland	Kesici Uç Uyumluluğu / Insert Suitability	FIYAT PRICE
			SCO XOMX 1204	EURO
TK XOMX 12 001 SCO	✓	X	EM90 40X4 016 XOMX 1204	89,67 €
TK XOMX 12 002 SCO	✓	X	EM90 50X5 022 XOMX 1204	111,33 €
TK XOMX 12 003 SCO	✓	X	EM90 63X6 022 XOMX 1204	132,67 €
TK XOMX 12 004 SCO	✓	X	EM90 80X8 027 XOMX 1204	151,33 €

3PKT 1505 TT

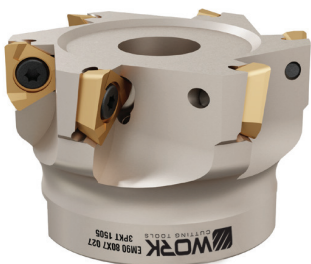

KOD	Stok Stock	Inter Cooland	Kesici Uç Uyumluluğu / Insert Suitability	FIYAT PRICE
			TT 3PKT 1505	EURO
TK 3PKT 15 001 TT	✓	✓	EM90 50X4 022 3PKT 1505	136,00 €
TK 3PKT 15 002 TT	✓	✓	EM90 63X5 022 3PKT 1505	163,00 €
TK 3PKT 15 003 TT	✓	✓	EM90 80X7 027 3PKT 1505	199,00 €
TK 3PKT 15 004 TT	✓	✓	EM90 100X8 032 3PKT 1505	259,00 €

90° APKT 1204 TT



KOD	Stok Stock	Inter Cooland	Kesici Uç Uyumluluğu / Insert Suitability	FİYAT PRICE
			TT APKT 1204	EURO
TK AP..12 001 TT	✓	✓	EM90 40X5 016 APKT 1204	103,67 €
TK AP..12 002 TT	✓	✓	EM90 50X6 022 APKT 1204	129,67 €
TK AP..12 003 TT	✓	✓	EM90 63X7 022 APKT 1204	146,67 €
TK AP..12 004 TT	✓	✓	EM90 80X8 027 APKT 1204	145,33 €

90° 3PKT 1004 TT



KOD	Stok Stock	Inter Cooland	Kesici Uç Uyumluluğu / Insert Suitability	FİYAT PRICE
			TT 3PKT 1004	EURO
TK 3PKT 10 001 TT	✓	✓	EM90 40X4 016 3PKT 1004	132,67 €
TK 3PKT 10 002 TT	✓	✓	EM90 50X5 022 3PKT 1004	157,67 €
TK 3PKT 10 003 TT	✓	✓	EM90 63X8 022 3PKT 1004	179,00 €

90° APMT 1135 TT



KOD	Stok Stock	Inter Cooland	Kesici Uç Uyumluluğu / Insert Suitability	FİYAT PRICE
			TT APMT 1135	EURO
TK APMT 1135 001 TT	✓	✓	EM90 40X5 016 APMT 1135	111,33 €
TK APMT 1135 003 TT	✓	✓	EM90 63X7 022 APMT 1135	129,67 €

90° 6NGU 0604 TT



KOD	Stok Stock	Inter Cooland	Kesici Uç Uyumluluğu / Insert Suitability	FIYAT PRICE
			TT 6NGU 0604	EURO
TK 6NGU 06 001 TT	✓	✓	EM90 40X4 016 6NGU 0604	129,67 €
TK 6NGU 06 002 TT	✓	✓	EM90 50X5 022 6NGU 0604	145,33 €
TK 6NGU 06 003 TT	✓	✓	EM90 63X6 016 6NGU 0604	160,67 €

90° 6NGU 0905 TT



KOD	Stok Stock	Inter Cooland	Kesici Uç Uyumluluğu / Insert Suitability	FIYAT PRICE
			TT 6NGU 0905	EURO
TK 6NGU 09 001 TT	✓	✓	EM90 50X5 022 6NGU 0905	120,67 €
TK 6NGU 09 002 TT	✓	✓	EM90 63X6 022 6NGU 0905	136,00 €
TK 6NGU 09 003 TT	✓	✓	EM90 80X7 027 6NGU 0905	163,67 €
TK 6NGU 09 004 TT	✓	✓	EM90 100X8 032 6NGU 0905	200,67 €
TK 6NGU 09 005 TT	✓	✗	EM90 125X10 040 6NGU 0905	253,00 €

90° AOMT 1236 MTSBSh



KOD	Stok Stock	Inter Cooland	Kesici Uç Uyumluluğu / Insert Suitability	FIYAT PRICE
			MTSBSh AOMT 1236	EURO
TK AOMT 12 001 MTSBSh	✓	✓	EM90 40X6 016 AOMT 1236	117,67 €
TK AOMT 12 002 MTSBSh	✓	✓	EM90 50X7 022 AOMT 1236	139,00 €
TK AOMT 12 003 MTSBSh	✓	✓	EM90 63X8 022 AOMT 1236	157,67 €
TK AOMT 12 004 MTSBSh	✓	✓	EM90 80X9 027 AOMT 1236	179,00 €

90° SOMT 12T3 MTSBSH

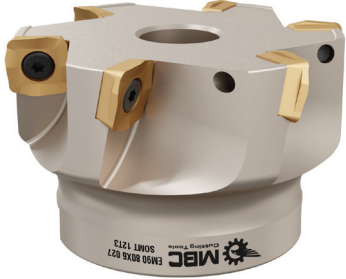

KOD	Stok Stock	Inter Cooland	Kesici Uç Uyumluluğu / Insert Suitability	FİYAT PRICE
			MTSBSH SOMT 12T3	EURO
TK SOMT 12 001 MTSBSH	✓	✓	EM90 50X4 022 SOMT 12T3	126,67 €
TK SOMT 12 002 MTSBSH	✓	✓	EM90 63X5 022 SOMT 12T3	117,67 €
TK SOMT 12 003 MTSBSH	✓	✓	EM90 80X6 027 SOMT 12T3	139,00 €
TK SOMT 12 004 MTSBSH	✓	✓	EM90 100X7 032 SOMT 12T3	154,33 €

90° AOMT 1848 MTSBSH

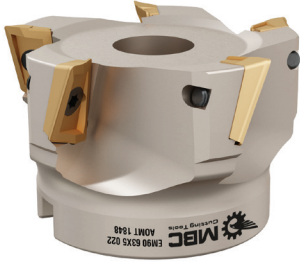

KOD	Stok Stock	Inter Cooland	Kesici Uç Uyumluluğu / Insert Suitability	FİYAT PRICE
			MTSBSH AOMT 1848	EURO
TK AOMT 18 001 MTSBSH	✓	✗	EM90 50x4 022 AOMT 1848	118,67 €
TK AOMT 18 002 MTSBSH	✓	✗	EM90 63X6 022 AOMT 1848	134,00 €
TK AOMT 18 003 MTSBSH	✓	✗	EM90 80X6 027 AOMT 1848	168,33 €
TK AOMT 18 004 MTSBSH	✓	✗	EM90 100X8 032 AOMT 1848	198,67 €

90° XDGT 1550 MTSBSH

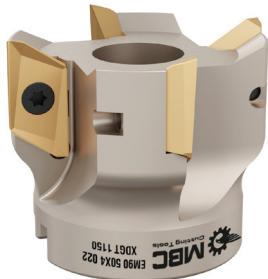

KOD	Stok Stock	Inter Cooland	Kesici Uç Uyumluluğu / Insert Suitability	FİYAT PRICE
			MTSBSH XDGT 1550	EURO
TK XDGT 15 001 MTSBSH	✓	✗	EM90 50X4 022 XDGT 1550	120,67 €
TK XDGT 15 002 MTSBSH	✓	✗	EM90 63X5 022 XDGT 1550	136,00 €

90° XNMU 1607 MTSBSH

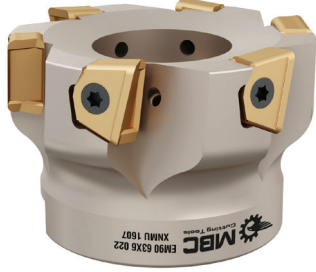

KOD	Stok Stock	Inter Cooland	Kesici Uç Uyumluluğu / Insert Suitability	FIYAT PRICE
			MTSBSH XNMU 1607	EURO
TK XNMU 16 001 MTSBSH	✓	✓	EM90 50X5 022 XNMU 1607	120,67 €
TK XNMU 16 002 MTSBSH	✓	✓	EM90 63X6 022 XNMU 1607	136,00 €
TK XNMU 16 003 MTSBSH	✓	✓	EM90 80X7 027 XNMU 1607	154,33 €

90° R390 1806 SNDVK

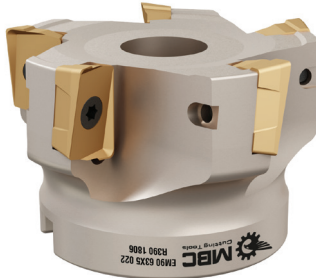

KOD	Stok Stock	Inter Cooland	Kesici Uç Uyumluluğu / Insert Suitability	FIYAT PRICE
			SNDVK R390 1806	EURO
TK R390 18 001 SNDVK	✓	✗	EM90 50X4 022 R390 1806	142,00 €
TK R390 18 002 SNDVK	✓	✗	EM90 63X5 022 R390 1806	154,33 €
TK R390 18 003 SNDVK	✓	✗	EM90 80X6 027 R390 1806	176,00 €
TK R390 18 004 SNDVK	✓	✗	EM90 100X8 032 R390 1806	185,33 €
TK R390 18 005 SNDVK	✓	✗	EM90 160X10 040 R390 1806	339,33 €
TK R390 18 006 SNDVK	✓	✗	EM90 125X9 040 R390 1806	305,67 €

90° R390 11T3 SNDVK



KOD	Stok Stock	Inter Cooland	Kesici Uç Uyumluluğu / Insert Suitability	FIYAT PRICE
			SNDVK R390 11T3	EURO
TK R390 11 001 SNDVK	✓	✓	EM90 40X5 016 R390 11T3	86,67 €
TK R390 11 002 SNDVK	✓	✓	EM90 50X6 022 R390 11T3	108,33 €
TK R390 11 003 SNDVK	✓	✓	EM90 63X7 022 R390 11T3	123,33 €

90° ADKT 1704 SNDVK



KOD	Stok Stock	Inter Cooland	Kesici Uç Uyumluluğu / Insert Suitability	FIYAT PRICE
			SNDVK R390 ADKT 1704	EURO
TK ADKT 17 001 SNDVK	✓	✗	EM90 40X4 016 R390 1704	83,67 €
TK ADKT 17 002 SNDVK	✓	✗	EM90 50X4 022 R390 1704	102,00 €
TK ADKT 17 003 SNDVK	✓	✗	EM90 63X5 022 R390 1704	123,33 €
TK ADKT 17 004 SNDVK	✓	✗	EM90 80X6 027 R390 1704	142,00 €

90° SE.. 1203 ZCC/SNDVK

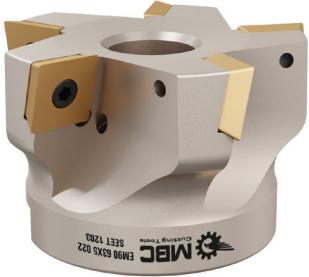

90° ANGX 1506 ZCC

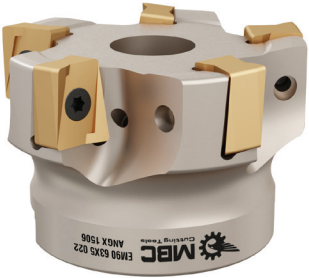

90° ANGX 1105 ZCC



90° APKT 11T3 ZCC



KOD	Stok Stock	Inter Cooland	Kesici Uç Uyumluluğu / Insert Suitability	FIYAT PRICE
			ZCC/SNDVK SEET 1203	EURO
TK SEET 12 001 ZCC	✓	✓	EM90 50X4 022 SEET 1203	92,67 €
TK SEET 12 002 ZCC	✓	✓	EM90 63X5 022 SEET 1203	120,67 €
TK SEET 12 003 ZCC	✓	✓	EM90 80X6 027 SEET 1203	142,00 €
TK SEET 12 004 ZCC	✓	✓	EM90 100X7 032 SEET 1203	170,00 €
TK SEET 12 005 ZCC	✓	✗	EM90 125X8 040 SEET 1203	226,67 €
TK SEET 12 006 ZCC	✓	✗	EM90 160X12 040 SEET 1203	370,33 €

KOD	Stok Stock	Inter Cooland	Kesici Uç Uyumluluğu / Insert Suitability	FIYAT PRICE
			ZCC ANGX 1506	EURO
TK ANGX 15 002 ZCC	✓	✓	EM90 40X4 016 ANGX 1506	99,00 €
TK ANGX 15 003 ZCC	✓	✓	EM90 50X4 022 ANGX 1506	99,00 €
TK ANGX 15 004 ZCC	✓	✓	EM90 63X5 022 ANGX 1506	114,33 €
TK ANGX 15 005 ZCC	✓	✓	EM90 80X6 027 ANGX 1506	139,00 €
TK ANGX 15 006 ZCC	✓	✓	EM90 100X8 032 ANGX 1506	185,33 €
TK ANGX 15 007 ZCC	✓	✗	EM90 125X9 040 ANGX 1506	302,67 €
TK ANGX 15 008 ZCC	✓	✗	EM90 160X12 040 ANGX 1506	401,33 €
TK ANGX 15 009 ZCC	✓	✗	EM90 200X14 060 ANGX 1506	740,67 €

KOD	Stok Stock	Inter Cooland	Kesici Uç Uyumluluğu / Insert Suitability	FIYAT PRICE
			ZCC ANGX 1105	EURO
TK ANGX 11 001 ZCC	✓	✓	EM90 50X6 022 ANGX 1105	102,00 €
TK ANGX 11 002 ZCC	✓	✓	EM90 63X7 022 ANGX 1105	126,67 €
TK ANGX 11 003 ZCC	✓	✓	EM90 40X4 016 ANGX 1105	92,67 €

KOD	Stok Stock	Inter Cooland	Kesici Uç Uyumluluğu / Insert Suitability	FIYAT PRICE
			ZCC APKT 11T3	EURO
TK APKT 11 001 ZCC	✓	✓	EM90 40X5 016 APKT 11T3	114,33 €
TK APKT 11 002 ZCC	✓	✓	EM90 50X6 022 APKT 11T3	142,00 €
TK APKT 11 003 ZCC	✓	✓	EM90 63X7 022 APKT 11T3	154,34 €

90° APKT 1604 ZCC

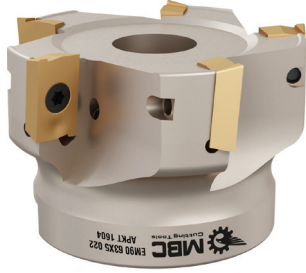

KOD	Stok Stock	Inter Cooland	Kesici Uç Uyumluluğu / Insert Suitability	FIYAT PRICE
			ZCC APKT 1604	EURO
TK AP 16 001 ZCC	✓	✗	EM90 40X4 016 APKT 1604	89,67 €
TK AP 16 002 ZCC	✓	✗	EM90 50X5 022 APKT 1604	108,33 €
TK AP 16 003 ZCC	✓	✗	EM90 63X5 022 APKT 1604	117,67 €
TK AP 16 004 ZCC	✓	✗	EM90 80X7 027 APKT 1604	142,00 €
TK AP 16 005 ZCC	✓	✗	EM90 100X8 032 APKT 1604	160,67 €
TK AP 16 006 ZCC	✓	✗	EM90 125X9 040 APKT 1604	256,33 €

90° WNHU 0806 ZCC

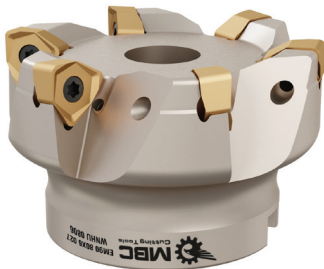

KOD	Stok Stock	Inter Cooland	Kesici Uç Uyumluluğu / Insert Suitability	FIYAT PRICE
			ZCC WNHU 0806	EURO
TK WNHU 08 001 ZCC	✓	✓	EM90 50X4 022 WNHU 0806	129,67 €
TK WNHU 08 002 ZCC	✓	✓	EM90 63X5 022 WNHU 0806	151,33 €
TK WNHU 08 003 ZCC	✓	✓	EM90 80X6 027 WNHU 0806	176,00 €
TK WNHU 08 008 ZCC	✓	✓	EM90 250X16 060 WNHU 0806	709,67 €
TK WNHU 08 009 ZCC	✓	✓	EM90 63X6 022 WNHU 0806	151,33 €
TK WNHU 08 010 ZCC	✓	✓	EM90 100X8 032 WNHU 0806	213,00 €
TK WNHU 08 012 ZCC	✓	✓	EM90 80X5 027 WNHU 0806	172,00 €

90° APKT 10T3 ZCC



KOD	Stok Stock	Inter Cooland	Kesici Uç Uyumluluğu / Insert Suitability	FIYAT PRICE
			ZCC APKT 10T3	EURO
TK APKT 10 001 ZCC	✓	✗	EM90 40X5 016 APKT 10T3	89,67 €
TK APKT 10 002 ZCC	✓	✗	EM90 50X6 022 APKT 10T3	108,33 €
TK APKT 10 003 ZCC	✓	✗	EM90 63X7 022 APKT 10T3	120,67 €

90° APLX 1008 ZCC



KOD	Stok Stock	Inter Cooland	Kesici Uç Uyumluluğu / Insert Suitability	FİYAT PRICE
			ZCC APLX 1008	EURO
TK APLX 10 001 ZCC	✓	✗	EM90 40X5 016 APLX 1008	89,67 €
TK APLX 10 002 ZCC	✓	✗	EM90 50X6 022 APLX 1008	108,33 €
TK APLX 10 003 ZCC	✓	✗	EM90 63X7 022 APLX 1008	117,67 €

90° LNKT 0804 ZCC



KOD	Stok Stock	Inter Cooland	Kesici Uç Uyumluluğu / Insert Suitability	FİYAT PRICE
			ZCC LNKT 0804	EURO
TK LNKT 08 001 ZCC	✓	✓	EM90 40X5 016 LNKT 0804	99,00 €

90° LNKT 1206 ZCC



KOD	Stok Stock	Inter Cooland	Kesici Uç Uyumluluğu / Insert Suitability	FİYAT PRICE
			ZCC LNKT 1206	EURO
TK LNKT 12 001 ZCC	✓	✓	EM90 50X5 022 LNKT 1206	105,33 €
TK LNKT 12 002 ZCC	✓	✓	EM90 63X6 022 LNKT 1206	123,33 €
TK LNKT 12 003 ZCC	✓	✓	EM90 80X7 027 LNKT 1206	151,33 €
TK LNKT 12 004 ZCC	✓	✓	EM90 100X9 032 LNKT 1206	200,67 €
TK LNKT 12 005 ZCC	✓	✗	EM90 125X11 040 LNKT 1206	253,00 €

90° EDPT 1404/1805 KNNMTL



KOD	Stok Stock	Inter Cooland	Kesici Uç Uyumluluğu / Insert Suitability		FIYAT PRICE
			KNNMTL EDPT 1404/1805		EURO
TK EDPT 14 001 KNM	✓	X	EM90 40X4 016 EDPT 1404		120,67 €
TK EDPT 14 002 KNM	✓	X	EM90 50X5 022 EDPT 1404		142,00 €
TK EDPT 14 004 KNM	✓	X	EM90 63X6 022 EDPT 1404		160,67 €
TK EDPT 14 005 KNM	✓	X	EM90 80X7 027 EDPT 1404		179,00 €
TK EDPT 14 006 KNM	✓	X	EM90 100X8 032 EDPT 1404		191,67 €
TK EDPT 18 007 KNM	✓	X	EM90 50X4 022 EDPT 1805		142,00 €
TK EDPT 18 008 KNM	✓	X	EM90 63X5 022 EDPT 1805		160,67 €
TK EDPT 18 009 KNM	✓	X	EM90 80X6 027 EDPT 1805		179,00 €

90° LNGU 1104 KNNMTL



KOD	Stok Stock	Inter Cooland	Kesici Uç Uyumluluğu / Insert Suitability		FIYAT PRICE
			KNNMTL LNGU 1104		EURO
TK LNGU 11 001 KNM	✓	✓	EM90 40X5 016 LNGU 1104		108,33 €
TK LNGU 11 003 KNM	✓	✓	EM90 63X6 022 LNGU 1104		142,00 €
TK LNGU 11 004 KNM	✓	✓	EM90 80X7 027 LNGU 1104		160,67 €
TK LNGU 11 005 KNM	✓	✓	EM90 50X6 022 LNGU 1104		120,67 €

90° TNGX 1905 KNNMTL

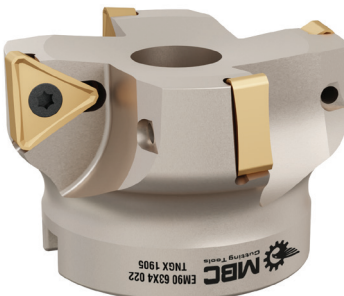

KOD	Stok Stock	Inter Cooland	Kesici Uç Uyumluluğu / Insert Suitability		FIYAT PRICE
			KNNMTL TNGX 1905		EURO
TK TNGX 19 002 KNM	✓	✓	EM90 63X5 022 TNGX 1905		173,00 €
TK TNGX 19 003 KNM	✓	✓	EM90 80X6 027 TNGX 1905		197,67 €

90° BDMT 1704 KYCR

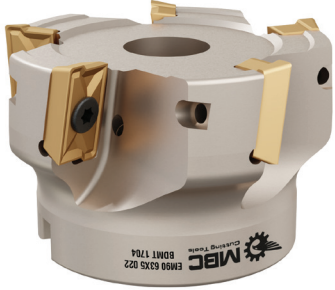

KOD	Stok Stock	Inter Cooland	Kesici Uç Uyumluluğu / Insert Suitability	FIYAT PRICE
			KYCR BDMT 1704	EURO
TK BDMT 17 001 KYCR	✓	✓	EM90 40X4 022 BDMT 1704	82,33 €
TK BDMT 17 004 KYCR	✓	✓	EM90 80X6 027 BDMT 1704	137,00 €

90° LOMU 1004 KYCR

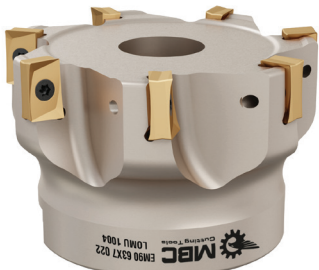

KOD	Stok Stock	Inter Cooland	Kesici Uç Uyumluluğu / Insert Suitability	FIYAT PRICE
			KYCR LOMU 1004	EURO
TK LOMU 10 000 KYCR	✓	✓	EM90 40X5 016 LOMU 1004	130,00 €
TK LOMU 10 001 KYCR	✓	✓	EM90 50X5 022 LOMU 1004	152,67 €
TK LOMU 10 003 KYCR	✓	✓	EM90 80X8 027 LOMU 1004	193,00 €
TK LOMU 10 004 KYCR	✓	✓	EM90 50X6 022 LOMU 1004	156,33 €
TK LOMU 10 005 KYCR	✓	✓	EM90 63X7 022 LOMU 1004	173,00 €

90° BDMT 11T3 KYCR



KOD	Stok Stock	Inter Cooland	Kesici Uç Uyumluluğu / Insert Suitability	FIYAT PRICE
			KYCR BDMT 11T3	EURO
TK BDMT 11 001 KYCR	✓	✓	EM90 40X5 016 BDMT 11T3	108,33 €
TK BDMT 11 002 KYCR	✓	✓	EM90 50X6 022 BDMT 11T3	123,33 €

90° WNMU 0504 KYCR



KOD	Stok Stock	Inter Cooland	Kesici Uç Uyumluluğu / Insert Suitability	FİYAT PRICE
			KYCR WNMU 0504	EURO
TK WNMU 05 001 KYCR	✓	✓	EM90 40X4 016 WNMU 0504	120,67 €
TK WNMU 05 002 KYCR	✓	✓	EM90 50X5 022 WNMU 0504	132,67 €

90° LOMU 1505 KYCR



KOD	Stok Stock	Inter Cooland	Kesici Uç Uyumluluğu / Insert Suitability	FİYAT PRICE
			KYCR LOMU 1505	EURO
TK LOMU 15 001 KYCR	✓	✓	EM90 50X4 022 LOMU 1505	120,67 €
TK LOMU 15 002 KYCR	✓	✓	EM90 63X5 022 LOMU 1505	148,33 €
TK LOMU 15 006 KYCR	✓	✗	EM90 160X12 040 LOMU 1505	421,33 €
TK LOMU 15 008 KYCR	✓	✗	EM90 200X14 060 LOMU 1505	682,67 €

90° WNMU 0806 KYCR

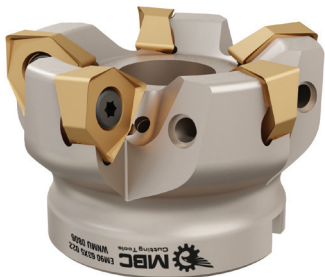

KOD	Stok Stock	Inter Cooland	Kesici Uç Uyumluluğu / Insert Suitability	FİYAT PRICE
			KYCR WNMU 0806	EURO
TK WNMU 08 001 KYCR	✓	✓	EM90 50X4 022 WNMU 0806	123,33 €
TK WNMU 08 002 KYCR	✓	✓	EM90 52X4 022 WNMU 0806	126,67 €
TK WNMU 08 004 KYCR	✓	✓	EM90 63X5 022 WNMU 0806	154,33 €
TK WNMU 08 006 KYCR	✓	✓	EM90 80X6 027 WNMU 0806	176,00 €
TK WNMU 08 007 KYCR	✓	✓	EM90 100X7 032 WNMU 0806	216,00 €
TK WNMU 08 008 KYCR	✓	✗	EM90 125X8 040 WNMU 0806	278,00 €
TK WNMU 08 009 KYCR	✓	✗	EM90 160X10 040 WNMU 0806	401,33 €
TK WNMU 08 011 KYCR	✓	✗	EM90 200X12 060 WNMU 0806	402,60 €

90° XNGU 15T6 WDA



KOD	Stok Stock	Inter Cooland	Kesici Uç Uyumluluğu / Insert Suitability	FIYAT PRICE
			WDA XNGU 15T6	EURO
TK XNGU 15 001 WDA	✓	✓	EM90 40X4 016 XNGU 15T6	99,00 €
TK XNGU 15 002 WDA	✓	✓	EM90 50X5 022 XNGU 15T6	108,33 €
TK XNGU 15 003 WDA	✓	✓	EM90 63X5 022 XNGU 15T6	120,67 €
TK XNGU 15 004 WDA	✓	✓	EM90 80X6 027 XNGU 15T6	148,33 €
TK XNGU 15 005 WDA	✓	✓	EM90 50X4 022 XNGU 15T6	108,33 €

90° XDPT 1104/1704 WDA



KOD	Stok Stock	Inter Cooland	Kesici Uç Uyumluluğu / Insert Suitability	FIYAT PRICE
			WDA XDPT 1104/1704	EURO
TK XDPT 11 001 WDA	✓	✓	EM90 40X5 016 XDPT 1104	114,33 €
TK XDPT 11 002 WDA	✓	✓	EM90 50X6 022 XDPT 1104	132,67 €
TK XDPT 17 002 WDA	✓	✓	EM90 63X6 022 XDPT 1704	145,33 €

90° BOMT 1304 INGRSL

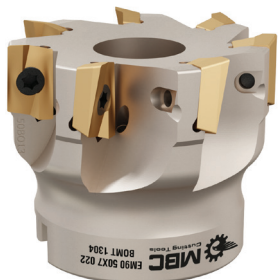

KOD	Stok Stock	Inter Cooland	Kesici Uç Uyumluluğu / Insert Suitability	FIYAT PRICE
			INGRSL BOMT 1304	EURO
TK BOMT 13 001 INGRSL	✓	X	EM90 50X7 022 BOMT 1304	120,67 €
TK BOMT 13 003 INGRSL	✓	X	EM90 63X8 022 BOMT 1304	132,67 €
TK BOMT 13 004 INGRSL	✓	X	EM90 80X10 027 BOMT 1304	173,00 €

90° AOMT 1605 INGRSL



KOD	Stok Stock	Inter Cooland	Kesici Uç Uyumluluğu / Insert Suitability	FIYAT PRICE
			INGRSL AOMT 1605	EURO
TK AOMT 16 001 INGRSL	✓	X	EM90 50X4 022 AOMT 1605	111,33 €
TK AOMT 16 002 INGRSL	✓	X	EM90 63X5 022 AOMT 1605	129,67 €
TK AOMT 16 003 INGRSL	✓	X	EM90 80X6 027 AOMT 1605	160,67 €
TK AOMT 16 004 INGRSL	✓	X	EM90 100X8 032 AOMT 1605	191,67 €

90° XDKT 1505 CRTZT



KOD	Stok Stock	Inter Cooland	Kesici Uç Uyumluluğu / Insert Suitability	FIYAT PRICE
			CRTZT XDKT 1505	EURO
TK XDKT 15 001 CRTZT	✓	X	EM90 50X4 022 XDKT 1505	105,33 €
TK XDKT 15 002 CRTZT	✓	X	EM90 63X5 022 XDKT 1505	129,67 €

90° AP..1805 DJT

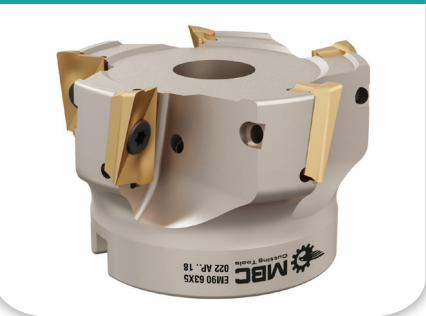

KOD	Stok Stock	Inter Cooland	Kesici Uç Uyumluluğu / Insert Suitability	FIYAT PRICE
			DJT AP.. 18	EURO
TK AP.. 18 001 DJT	✓	X	EM90 63X5 022 AP.. 18	148,33 €
TK AP.. 18 002 DJT	✓	X	EM90 100X8 032 AP..18	213,00 €

88° SNMX 1206 KRLY



KOD	Stok Stock	Inter Cooland	Kesici Uç Uyumluluğu / Insert Suitability	FIYAT PRICE
			KRLY SNMX 1206	EURO
TK SNMX 12 001 KRLY	✓	✓	EM88 50X5 022 SNMX 1206	102,00 €
TK SNMX 12 002 KRLY	✓	✓	EM88 63X6 022 SNMX 1206	112,33 €
TK SNMX 12 003 KRLY	✓	✓	EM88 80X8 027 SNMX 1206	145,67 €
TK SNMX 12 004 KRLY	✓	✓	EM88 100X10 032 SNMX 1206	198,33 €
TK SNMX 12 005 KRLY	✓	✗	EM88 125X11 040 SNMX 1206	256,33 €
TK SNMX 12 006 KRLY	✓	✗	EM88 160X12 040 SNMX 1206	358,00 €
TK SNMX 12 007 KRLY	✓	✗	EM88 160X14 040 SNMX 1206	395,00 €
TK SNMX 12 009 KRLY	✓	✗	EM88 200X14 060 SNMX 1206	533,33 €

88° SNCU 1205 ZCC



KOD	Stok Stock	Inter Cooland	Kesici Uç Uyumluluğu / Insert Suitability	FIYAT PRICE
			KYCR SNCU 1205	EURO
TK SNCU 12 006 ZCC	✓	✗	EM88 160X12 040 SNCU 1205	371,33 €

75° APKT 1003/1604 ISO



KOD	Stok Stock	Inter Cooland	Kesici Uç Uyumluluğu / Insert Suitability	FIYAT PRICE
			ISO APKT 1003/1604	EURO
TK EM 75 AP 10 007 ISO	✓	✓	EM75 63X6 022 APKT 1003	120,67 €
TK EM 75 AP 16 001 ISO	✓	✓	EM75 63X4 022 AP.1604	111,33 €
TK EM 75 AP 16 002 ISO	✓	✓	EM75 80X5 027 AP.1604	136,00 €
TK EM 75 AP 16 003 ISO	✓	✓	EM75 100X6 032 AP.1604	163,67 €
TK EM 75 AP 16 004 ISO	✓	✓	EM75 125X7 040 AP.1604	244,00 €
TK EM 75 AP 16 005 ISO	✓	✓	EM75 160X8 040 AP.1604	370,33 €

75° SPKN 1203/1504 ISO



75° R390 1806 SNDVK



75° R390 1704 SNDVK



45° OFKT 05T3 ZCC

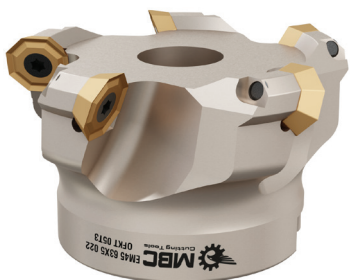

KOD	Stok Stock	Inter Cooland	Kesici Uç Uyumluluğu / Insert Suitability		FIYAT PRICE
			ISO SPKN 1203		EURO
TK SPKN 12 001 ISO	✓	✗	EM75 63X5 022 SPKN 1203		160,67 €
TK SPKN 12 002 ISO	✓	✗	EM75 80X6 027 SPKN 1203		182,33 €
TK SPKN 12 003 ISO	✓	✗	EM75 100X8 032 SPKN 1203		244,00 €
TK SPKN 12 004 ISO	✓	✗	EM75 125X10 040 SPKN 1203		305,67 €
TK SPKN 12 005 ISO	✓	✗	EM75 160X12 040 SPKN 1203		370,33 €
TK SPKN 12 006 ISO	✓	✗	EM75 200X12 060 SPKN 1203		463,00 €
TK SPKN 15 001 ISO	✓	✗	EM75 125X10 040 SPKN 1504		305,67 €

KOD	Stok Stock	Inter Cooland	Kesici Uç Uyumluluğu / Insert Suitability		FIYAT PRICE
			SNDVK R390 1806		EURO
TK 75 R390 18 000 SNDVK	✓	✗	EM75 80X4 027 R390 1806		167,33 €
TK 75 R390 18 001 SNDVK	✓	✗	EM75 100X5 032 R390 1806		182,33 €
TK 75 R390 18 002 SNDVK	✓	✗	EM75 125X6 040 R390 1806		274,67 €

KOD	Stok Stock	Inter Cooland	Kesici Uç Uyumluluğu / Insert Suitability		FIYAT PRICE
			SNDVK R390 1704		EURO
TK 75 ADKT 17 004 SNDVK	✓	✗	EM75 63X4 022 R390 1704		120,67 €
TK 75 ADKT 17 005 SNDVK	✓	✗	EM75 80X5 027 R390 1704		145,33 €
TK 75 ADKT 17 006 SNDVK	✓	✗	EM75 100X6 032 R390 1704		173,00 €

KOD	Stok Stock	Inter Cooland	Kesici Uç Uyumluluğu / Insert Suitability		FIYAT PRICE
			ZCC OFKT 05T3		EURO
TK OFKT 05 001 ZCC	✓	✓	EM45 50X4 022 OFKT 05T3		108,33 €
TK OFKT 05 002 ZCC	✓	✓	EM45 63X5 022 OFKT 05T3		120,67 €
TK OFKT 05 003 ZCC	✓	✓	EM45 80X6 027 OFKT 05T3		151,33 €
TK OFKT 05 004 ZCC	✓	✓	EM45 100X7 032 OFKT 05T3		210,00 €

45° ONHU 08T6 ZCC

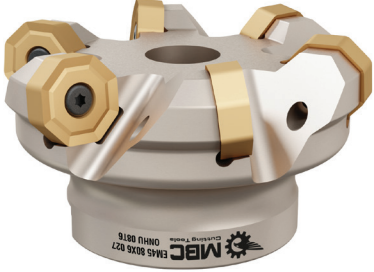

45° ONHU 060408 ZCC

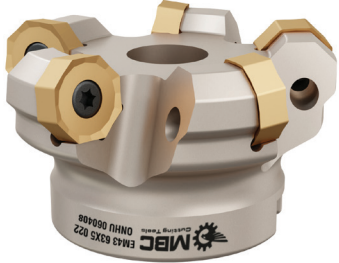

45° ONHU 0806 ZCC



45° SNEG 1205 ZCC

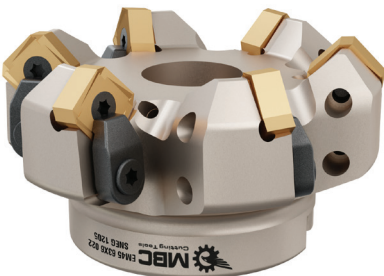

KOD	Stok Stock	Inter Cooland	Kesici Uç Uyumluluğu / Insert Suitability		FIYAT PRICE
			ZCC ONHU 08T6		EURO
TK ONHU 08T 000 ZCC	✓	✓	EM45 50X4 022 ONHU 08T6		132,67 €
TK ONHU 08T 002 ZCC	✓	✓	EM45 80X6 027 ONHU 08T6		185,33 €
TK ONHU 08T 003 ZCC	✓	✓	EM45 100X7 032 ONHU 08T6		262,33 €
TK ONHU 08T 004 ZCC	✓	✗	EM45 125X8 040 ONHU 08T6		339,33 €
TK ONHU 08T 005 ZCC	✓	✗	EM45 160X10 040 ONHU 08T6		401,33 €

KOD	Stok Stock	Inter Cooland	Kesici Uç Uyumluluğu / Insert Suitability		FIYAT PRICE
			ZCC ONHU 060408		EURO
TK ONHU 06 002 ZCC	✓	✗	EM43 63X5 022 ONHU 060408 ANN		157,67 €
TK ONHU 06 003 ZCC	✓	✗	EM43 80X7 027 ONHU 060408 ANN		185,33 €
TK ONHU 06 004 ZCC	✓	✗	EM43 100X8 032 ONHU 060408 ANN		253,00 €
TK ONHU 06 005 ZCC	✓	✗	EM43 125X9 040 ONHU 060408 ANN		339,33 €

KOD	Stok Stock	Inter Cooland	Kesici Uç Uyumluluğu / Insert Suitability		FIYAT PRICE
			ZCC ONHU 0806		EURO
TK ONHU 08 001 ZCC	✓	✓	EM45 63X5 022 ON..0806		160,67 €
TK ONHU 08 002 ZCC	✓	✓	EM45 80X6 027 ON..0806		185,33 €
TK ONHU 08 003 ZCC	✓	✓	EM45 100X7 032 ON..0806		262,33 €

KOD	Stok Stock	Inter Cooland	Kesici Uç Uyumluluğu / Insert Suitability		FIYAT PRICE
			ZCC SNEG 1205		EURO
TK SNEG 12 001 ZCC	✓	✓	EM45 63X6 022 SNEG 1205		129,67 €
TK SNEG 12 002 ZCC	✓	✓	EM45 80X7 027 SNEG 1205		165,00 €
TK SNEG 12 003 ZCC	✓	✗	EM45 125X10 040 SNEG 1205		293,33 €
TK SNEG 12 005 ZCC	✓	✓	EM45 50X5 022 SNEG 1205		120,67 €
TK SNEG 12 006 ZCC	✓	✓	EM45 100X8 032 SNEG 1205		176,00 €

45° SE..12T3/SE 15..ZCC/SNDVK



45° OFMT 0706 ISO



45° ONGX 0606 ISO

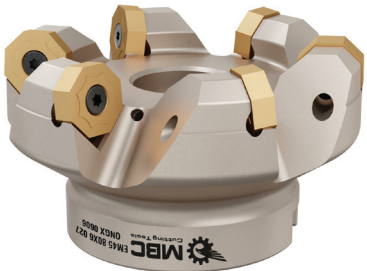

45° ONMU 0504 ISO



KOD	Stok Stock	Inter Cooland	Kesici Uç Uyumluluğu / Insert Suitability		FIYAT PRICE
			ZCC - SNDVK SEET 12T3/SE 15..		EURO
TK SE.. 12 001 ZCC	✓	✓	EM45 50X4 022 SE..12T3		92,67 €
TK SE.. 12 002 ZCC	✓	✓	EM45 63X5 022 SE..12T3		120,67 €
TK SE.. 12 003 ZCC	✓	✓	EM45 80X6 027 SE..12T3		142,00 €
TK SE.. 12 004 ZCC	✓	✓	EM45 100X7 032 SE..12T3		170,00 €
TK SE.. 12 005 ZCC	✓	✓	EM45 125X8 040 SE..12T3		226,67 €
TK SE.. 12 007 ZCC	✓	✗	EM45 160X10 040 SE..12T3		370,33 €

KOD	Stok Stock	Inter Cooland	Kesici Uç Uyumluluğu / Insert Suitability		FIYAT PRICE
			ISO OFMT 0706		EURO
TK OFMT 07 001 ISO	✓	✓	EM45 63X5 022 OFMT 0706		163,67 €
TK OFMT 07 002 ISO	✓	✓	EM45 80X6 027 OFMT 0706		182,33 €
TK OFMT 07 003 ISO	✓	✓	EM45 100X7 032 OFMT 0706		253,00 €
TK OFMT 07 004 ISO	✓	✗	EM45 125X8 040 OFMT 0706		305,67 €

KOD	Stok Stock	Inter Cooland	Kesici Uç Uyumluluğu / Insert Suitability		FIYAT PRICE
			ISO ONGX 0606		EURO
TK ONGX 06 001 ISO	✓	✓	EM45 63X5 022 ONGX 0606		148,33 €
TK ONGX 06 002 ISO	✓	✓	EM45 80X6 027 ONGX 0606		170,00 €
TK ONGX 06 003 ISO	✓	✓	EM45 100X8 032 ONGX 0606		216,00 €
TK ONGX 06 005 ISO	✓	✗	EM45 160X10 040 ONGX 0606		370,33 €

KOD	Stok Stock	Inter Cooland	Kesici Uç Uyumluluğu / Insert Suitability		FIYAT PRICE
			ISO ONMU 0504		EURO
TK ONMU 05 001 ISO	✓	✓	EM45 50X5 022 ONMU 0504		120,67 €
TK ONMU 05 002 ISO	✓	✓	EM45 63X6 022 ONMU 0504		148,33 €
TK ONMU 05 003 ISO	✓	✓	EM45 80X7 027 ONMU 0504		173,00 €
TK ONMU 05 004 ISO	✓	✓	EM45 100X8 032 ONMU 0504		225,33 €
TK ONMU 05 005 ISO	✓	✗	EM45 125X9 040 ONMU 0504		305,67 €

45° PNCU 0805 ISO



KOD	Stok Stock	Inter Cooland	Kesici Uç Uyumluluğu / Insert Suitability		FIYAT PRICE
			INGRSL PNCU 0805		EURO
TK PNCU 08 003 INGRSL	✓	✓	EM45 50X5 022 PNCU 0805		117,67 €
TK PNCU 08 004 INGRSL	✓	✓	EM45 80X6 027 PNCU 0805		172,67 €
TK PNCU 08 005 INGRSL	✓	✓	EM45 63X5 022 PNCU 0805		140,33 €

45° SEKR 1204 ISO

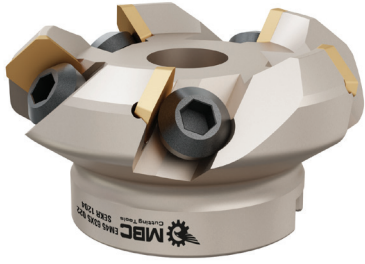

KOD	Stok Stock	Inter Cooland	Kesici Uç Uyumluluğu / Insert Suitability		FIYAT PRICE
			ISO SEKR 1204		EURO
TK SEKR 12 001 ISO	✓	✓	EM45 63X5 022 SEKR 1204		132,67 €
TK SEKR 12 002 ISO	✓	✓	EM45 100X8 032 SEKR 1204		191,67 €

45° SN.. 1206 KRLY



KOD	Stok Stock	Inter Cooland	Kesici Uç Uyumluluğu / Insert Suitability		FIYAT PRICE
			KRLY SN..1206		EURO
TK SN.. 12 001 KRLY	✓	✓	EM45 50X5 022 SN..1206		119,33 €
TK SN.. 12 002 KRLY	✓	✓	EM45 63X6 022 SN..1206		142,33 €
TK SN.. 12 003 KRLY	✓	✓	EM45 80X8 027 SN..1206		165,00 €
TK SN.. 12 004 KRLY	✓	✓	EM45 100X10 032 SN..1206		182,67 €
TK SN.. 12 005 KRLY	✓	X	EM45 125X11 040 SN..1206		305,33 €
TK SN.. 12 006 KRLY	✓	X	EM45 160X12 040 SN..1206		370,33 €

45° SNMX 1407 SECO

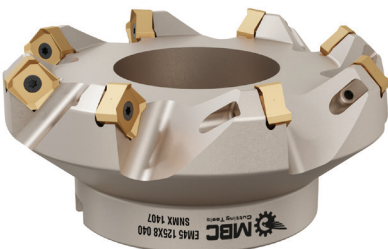

KOD	Stok Stock	Inter Cooland	Kesici Uç Uyumluluğu / Insert Suitability		FIYAT PRICE
			SECO SNMX 1407		EURO
TK SNMX 14 004 SECO	✓	X	EM45 100X7 032 SNMX 1407		265,33 €
TK SNMX 14 005 SECO	✓	X	EM45 125X8 040 SNMX 1407		339,33 €

45° SNHG 1205 VNDRT



KOD	Stok Stock	Inter Cooland	Kesici Uç Uyumluluğu / Insert Suitability	FIYAT PRICE
			VNDRT SNHG 1205	EURO
TK SNHG 12 001 VNDRT	✓	✓	EM45 50X6 022 SNHG 1205	108,33 €
TK SNHG 12 002 VNDRT	✓	✓	EM45 63X6 022 SNHG 1205	132,67 €
TK SNHG 12 003 VNDRT	✓	✓	EM45 80X7 027 SNHG 1205	160,67 €
TK SNHG 12 004 VNDRT	✓	✓	EM45 100X8 032 SNHG 1205	191,67 €

45° SNGU 1408 MTSBSH



KOD	Stok Stock	Inter Cooland	Kesici Uç Uyumluluğu / Insert Suitability	FIYAT PRICE
			MTSBSH SNGU 1408	EURO
TK SNGU 14 001 MTSBSH	✓	✓	EM45 63X5 022 SNGU 1408	126,33 €
TK SNGU 14 002 MTSBSH	✓	✓	EM45 80X7 027 SNGU 1408	166,67 €
TK SNGU 14 003 MTSBSH	✓	✓	EM45 100X8 032 SNGU 1408	202,00 €

45° SNMX 1306 TT

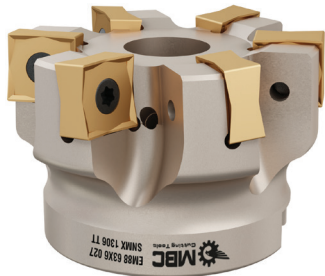

KOD	Stok Stock	Inter Cooland	Kesici Uç Uyumluluğu / Insert Suitability	FIYAT PRICE
			TT SNMX 1306	EURO
TK SNMX 13 001 TT	X	✓	EM88 63X6 027 SNMX 1306 TT	108,00 €
TK SNMX 13 002 TT	X	✓	EM88 80X8 027 SNMX 1306 TT	133,33 €
TK SNMX 13 003 TT	X	✓	EM88 100X10 032 SNMX 1306 TT	202,00 €

45° SNMU 13T6 SMTM

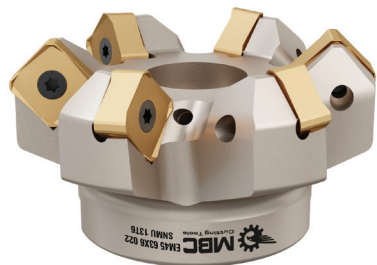

KOD	Stok Stock	Inter Cooland	Kesici Uç Uyumluluğu / Insert Suitability	FIYAT PRICE
			SMTM SNMU 13T6	EURO
TK SNMU 13T 001 SMTM	✓	✓	EM45 63X6 022 SNMU 13T6	142,33 €
TK SNMU 13T 002 SMTM	✓	✓	EM45 80X7 027 SNMU 13T6	170,33 €
TK SNMU 13T 003 SMTM	✓	✓	EM45 100X8 032 SNMU 13T6	207,33 €

45° SN.. 1305 I

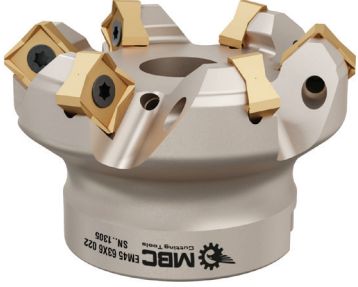

KOD	Stok Stock	Inter Cooland	Kesici Uç Uyumluluğu / Insert Suitability		FIYAT PRICE
			I SN..1305		EURO
TK SN..13 001 I	✓	✓	EM45 50X4 022 SN..1305		129,67 €
TK SN..13 002 I	✓	✓	EM45 63X6 022 SN..1305		160,67 €
TK SN..13 003 I	✓	✓	EM45 80X7 027 SN..1305		182,33 €
TK SN..13 004 I	✓	✓	EM45 100X8 032 SN..1305		216,00 €
TK SN..13 005 I	✓	x	EM45 125X9 040 SN..1305		274,67 €

45° PNMU 0905/1205 KYCR



KOD	Stok Stock	Inter Cooland	Kesici Uç Uyumluluğu / Insert Suitability		FIYAT PRICE
			KYCR PNMU 0905/1205		EURO
TK PNMU 12 002 KYCR	✓	✓	EM45 50X4 022 PNMU 1205		117,67 €
TK PNMU 12 003 KYCR	✓	✓	EM45 63X5 022 PNMU 1205		132,67 €
TK PNMU 12 004 KYCR	✓	✓	EM45 80X5 027 PNMU 1205		160,67 €
TK PNMU 12 005 KYCR	✓	✓	EM45 100X8 032 PNMU 1205		262,33 €
TK PNMU 12 006 KYCR	✓	x	EM45 125X10 040 PNMU 1205		302,67 €
TK PNMU 12 007 KYCR	✓	x	EM45 160X12 040 PNMU 1205		370,33 €
TK PNMU 12 009 KYCR	✓	x	EM45 250X14 060 PNMU 1205		709,67 €

45° PNMU 0905 SNG



KOD	Stok Stock	Inter Cooland	Kesici Uç Uyumluluğu / Insert Suitability		FIYAT PRICE
			SNG PNMU 0905		EURO
TK PNMU 09 001 SNG	✓	✓	EM45 50X4 022 PNMU 0905		117,67 €
TK PNMU 09 003 SNG	✓	✓	EM45 80X6 027 PNMU 0905		176,00 €
TK PNMU 09 004 SNG	✓	✓	EM45 100X7 032 PNMU 0905		200,67 €
TK PNMU 09 005 SNG	✓	✓	EM45 125X10 040 PNMU 0905		302,67 €

45° HN..0604 KNNMTL

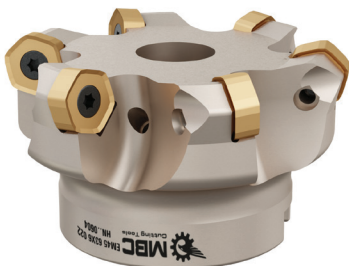

KOD	Stok Stock	Inter Cooland	Kesici Uç Uyumluluğu / Insert Suitability		FIYAT PRICE
			KNNMTL HN..0604		EURO
TK HN.. 06 002 KNM	✓	✓	EM45 63X6 022 HN..0604		151,33 €
TK HN.. 06 003 KNM	✓	✓	EM45 80X6 027 HN..0604		182,33 €
TK HN.. 06 004 KNM	✓	✓	EM45 100X8 032 HN..0604		197,67 €

45° HNGJ 0905 WDA/KNNMTL



45° HNPJ 0704 WDA



45° HN.. 0906 PRMT



44° ONMU 0505 I



KOD	Stok Stock	Inter Cooland	Kesici Uç Uyumluluğu / Insert Suitability		FİYAT PRICE
			WDA-KNNMTL HNGJ 0905		EURO
TK HN.. 09 001 KN WD	✓	✓	EM45 50X4 022 HN..0905		139,00 €
TK HN.. 09 002 KN WD	✓	✓	EM45 63X4 022 HN..0905		151,33 €
TK HN.. 09 004 KN WD	✓	✓	EM45 80X6 027 HN..0905		166,67 €
TK HN.. 09 005 KN WD	✓	✓	EM45 100X8 032 HN..0905		252,67 €
TK HN.. 09 006 KN WD	✓	✗	EM45 125X10 040 HN..0905		328,33 €
TK HN.. 09 007 KN WD	✓	✗	EM45 160X12 040 HN..0905		401,33 €
TK HN.. 09 010 KNM WD	✓	✗	EM45 250X14 060 HN..0905		679,00 €

KOD	Stok Stock	Inter Cooland	Kesici Uç Uyumluluğu / Insert Suitability		FİYAT PRICE
			WDA HNPJ 0704		EURO
TK HNPJ 07 001 WDA	✓	✓	EM45 50X4 022 HNPJ 0704		137,00 €
TK HNPJ 07 002 WDA	✓	✓	EM45 63X5 022 HNPJ 0704		147,67 €
TK HNPJ 07 004 WDA	✓	✓	EM45 80X6 027 HNPJ 0704		168,67 €
TK HNPJ 07 006 WDA	✓	✓	EM45 100X7 032 HNPJ 0704		247,67 €
TK HNPJ 07 007 WDA	✓	✗	EM45 125X8 040 HNPJ 0704		328,33 €
TK HNPJ 07 008 WDA	✓	✗	EM45 160X10 040 HNPJ 0704		393,00 €
TK HNPJ 07 009 WDA	✓	✓	EM45 50X5 022 HNPJ 0704		147,67 €

KOD	Stok Stock	Inter Cooland	Kesici Uç Uyumluluğu / Insert Suitability		FİYAT PRICE
			PRMT HN.. 0906		EURO
TK HN.. 09 001 PRMT	✓	✓	EM45 50X4 022 HN..0906		139,00 €
TK HN.. 09 003 PRMT	✓	✓	EM45 80X6 027 HN..0906		166,67 €
TK HN.. 09 004 PRMT	✓	✓	EM45 100X8 032 HN..0906		252,67 €
TK HN.. 09 005 PRMT	✓	✓	EM45 125X10 040 HN..0906		328,33 €
TK HN.. 09 006 PRMT	✓	✗	EM45 160X12 040 HN..0906		400,00 €
TK HN.. 09 007 PRMT	✓	✗	EM45 200X12 060 HN..0906		524,67 €
TK HN.. 09 008 PRMT	✓	✗	EM45 250X12 060 HN..0906		679,00 €
TK HN.. 09 010 PRMT	✓	✗	EM45 300X16 060 HN..0906		1.014,33 €
TK HN.. 09 011 PRMT	✓	✓	EM45 63X5 022 HN..0906		151,00 €

KOD	Stok Stock	Inter Cooland	Kesici Uç Uyumluluğu / Insert Suitability		FİYAT PRICE
			I ONMU 0505		EURO
TK ON..05 001 I	✓	✓	EM44 40X3 016 ON..0505		105,33 €
TK ON..05 002 I	✓	✓	EM44 50X4 022 ON..0505		129,67 €
TK ON..05 003 I	✓	✓	EM44 63X6 022 ON..0505		160,67 €
TK ON..05 004 I	✓	✓	EM44 80X7 027 ON..0505		182,33 €
TK ON..05 005 I	✓	✓	EM44 100X8 032 ON..0505		216,00 €
TK ON..05 006 I	✓	✗	EM44 125X9 040 ON..0505		274,67 €

44° ONMX 1205 VNDRT



KOD	Stok Stock	Inter Cooland	Kesici Uç Uyumluluğu / Insert Suitability	FIYAT PRICE
			VNDRT ONMX 1205	EURO
TK ONMX 12 001 VNDRT	✓	✓	EM44 50X5 022 ONMX 1205	132,67 €
TK ONMX 12 002 VNDRT	✓	✓	EM44 63X6 022 ONMX 1205	148,33 €
TK ONMX 12 003 VNDRT	✓	✓	EM44 80X7 027 ONMX 1205	179,00 €

40° NNMU 2007 MTSBSH

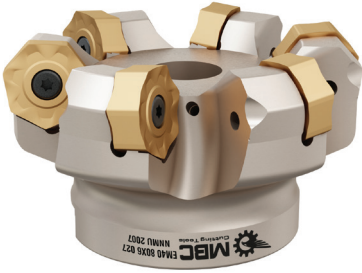

KOD	Stok Stock	Inter Cooland	Kesici Uç Uyumluluğu / Insert Suitability	FIYAT PRICE
			MTSBSH NNMU 2007	EURO
TK NNMU 20 001 MTSBSH	✓	✓	EM40 63X5 022 NNMU 2007	166,67 €
TK NNMU 20 002 MTSBSH	✓	✓	EM40 80X6 027 NNMU 2007	194,67 €
TK NNMU 20 003 MTSBSH	✓	✓	EM40 100X7 032 NNMU 2007	225,33 €
TK NNMU 20 004 MTSBSH	✓	✗	EM40 125X8 040 NNMU 2007	290,33 €
TK NNMU 20 005 MTSBSH	✓	✗	EM40 160X10 040 NNMU 2007	370,33 €
TK NNMU 20 006 MTSBSH	✓	✗	EM40 200X12 060 NNMU 2007	679,00 €

67° PNEG 1105 ZCC



KOD	Stok Stock	Inter Cooland	Kesici Uç Uyumluluğu / Insert Suitability	FIYAT PRICE
			ZCC PNEG 1105	EURO
TK PNEG 11 001 ZCC	✓	✓	EM67 50X5 022 PNEG 1105	129,67 €
TK PNEG 11 002 ZCC	✓	✓	EM67 63X6 022 PNEG 1105	142,00 €
TK PNEG 11 003 ZCC	✓	✓	EM67 80X8 027 PNEG 1105	170,00 €
TK PNEG 11 004 ZCC	✓	✓	EM67 100X10 032 PNEG 1105	222,33 €
TK PNEG 11 005 ZCC	✓	✗	EM67 125X12 040 PNEG 1105	299,67 €
TK PNEG 11 006 ZCC	✓	✗	EM67 160X14 040 PNEG 1105	370,33 €

SDMT 09T3 ZCC

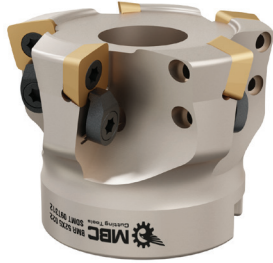

KOD	Stok Stock	Inter Cooland	Kesici Uç Uyumluluğu / Insert Suitability	FIYAT PRICE
			ZCC SDMT 09T312	EURO
TK SDMT 09 001 ZCC	✓	✓	BMR 40X4 016 SDMT 09T312	105,33 €
TK SDMT 09 002 ZCC	✓	✓	BMR 50X4 022 SDMT 09T312	124,67 €
TK SDMT 09 004 ZCC	✓	✓	BMR 50X5 022 SDMT 09T312	127,33 €
TK SDMT 09 005 ZCC	✓	✓	BMR 52X5 022 SDMT 09T312	127,33 €
TK SDMT 09 006 ZCC	✓	✓	BMR 52X6 022 SDMT 09T312	133,33 €
TK SDMT 09 007 ZCC	✓	✓	BMR 60X6 022 SDMT 09T312	144,67 €
TK SDMT 09 008 ZCC	✓	✓	BMR 63X6 022 SDMT 09T312	144,67 €
TK SDMT 09 009 ZCC	✓	✓	BMR 80X7 027 SDMT 09T3	163,33 €
TK SDMT 09 010 ZCC	✓	✓	BMR 100X8 032 SDMT 09T3	201,00 €

SDMT 1204 ZCC



KOD	Stok Stock	Inter Cooland	Kesici Uç Uyumluluğu / Insert Suitability	FIYAT PRICE
			ZCC SDMT 1204	EURO
TK SDMT 12 001 ZCC	✓	✓	BMR 50X5 022 SDMT 1204 ZCC	119,33 €
TK SDMT 12 002 ZCC	✓	✓	BMR 52X4 022 SDMT 1204 ZCC	121,33 €
TK SDMT 12 003 ZCC	✓	✓	BMR 66X5 022 SDMT 1204 ZCC	149,33 €
TK SDMT 12 004 ZCC	✓	✓	BMR 66X5 027 SDMT 1204 ZCC	149,33 €
TK SDMT 12 005 ZCC	✓	✓	BMR 80X6 027 SDMT 1204 ZCC	156,33 €
TK SDMT 12 006 ZCC	✓	✓	BMR 50X4 022 SDMT 1204 ZCC	117,67 €
TK SDMT 12 007 ZCC	✓	✓	BMR 63X5 022 SDMT 1204 ZCC	144,00 €
TK SDMT 12 008 ZCC	✓	✓	BMR 100X8 032 SDMT 1204 ZCC	181,00 €

SDMT 1204 ISO



KOD	Stok Stock	Inter Cooland	Kesici Uç Uyumluluğu / Insert Suitability	FIYAT PRICE
			ISO SDMT 1204	EURO
TK SDMT 12 001 ISO	✓	✓	BMR 52X4 022 SDMT 1204	127,33 €
TK SDMT 12 002 ISO	✓	✓	BMR 66X5 022 SDMT 1204	145,67 €
TK SDMT 12 003 ISO	✓	✓	BMR 80X6 027 SDMT 1204	182,33 €

ZCDW 09T3 ZDEW 1204 PRMT



KOD	Stok Stock	Inter Cooland	Kesici Uç Uyumluluğu / Insert Suitability	FIYAT PRICE
			PRMT ZDCW 09T3- ZDEW 1204	EURO
TK ZDCW 09 001 PRMT	✓	✓	BMR 40X4 016 ZDCW 09T304	130,00 €
TK ZDCW 12 002 PRMT	✓	✓	BMR 50X4 022 ZDEW 12408	152,67 €
TK ZDCW 12 003 PRMT	✓	✓	BMR 63X5 022 ZDEW 12408	191,67 €

SDMT 1004 BHLR

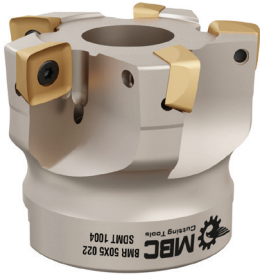

KOD	Stok Stock	Inter Cooland	Kesici Uç Uyumluluğu / Insert Suitability	FIYAT PRICE
			BHLR SDMT 1004	EURO
TK SDMT 10 002 BHLR	✓	✓	BMR 50X5 022 SDMT 1004	123,33 €
TK SDMT 10 003 BHLR	✓	✓	BMR 40X4 016 SDMT 1004	116,00 €

SDMT 1206 ING



KOD	Stok Stock	Inter Cooland	Kesici Uç Uyumluluğu / Insert Suitability	FIYAT PRICE
			ING SDMT 1206	EURO
TK SDMT 12 002 ING	✗	✓	BMR 63X5 022 SDMT 1206 ING	139,00 €
TK SDMT 12 003 ING	✗	✓	BMR 80X6 027 SDMT 1206 ING	222,33 €

SOEW 13M510 PLBT

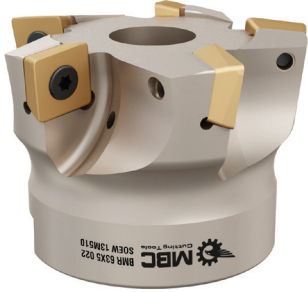

KOD	Stok Stock	Inter Cooland	Kesici Uç Uyumluluğu / Insert Suitability	FIYAT PRICE
			PLBT SOEW 13M510	EURO
TK SOEW 13 001 PLBT	✓	✓	BMR 52X4 022 SOEW 13	117,67 €
TK SOEW 13 002 PLBT	✓	✓	BMR 63X5 022 SOEW 13	145,33 €

SDMX 09T3 PLBT

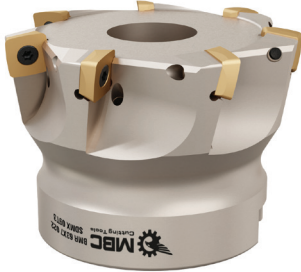

KOD	Stok Stock	Inter Cooland	Kesici Uç Uyumluluğu / Insert Suitability	FIYAT PRICE
			PLBT SDMX 09T3	EURO
TK SDMX 09 001 PLBT	✓	✓	BMR 42X6 016 SDMX 09T3	117,67 €
TK SDMX 09 002 PLBT	✓	✓	BMR 52X7 022 SDMX 09T3	142,00 €
TK SDMX 09 004 PLBT	✓	✓	BMR 50X6 022 SDMX 09T3	142,00 €

SOMT 1004/1405 KYCR



KOD	Stok Stock	Inter Cooland	Kesici Uç Uyumluluğu / Insert Suitability	FIYAT PRICE
			KYCR SOMT 1004-1405	EURO
TK SOMT 10 001 KYCR	✓	✓	BMR 50X5 022 SOMT 1004	126,67 €
TK SOMT 10 002 KYCR	✓	✓	BMR 52X5 022 SOMT 1004	126,67 €
TK SOMT 14 004 KYCR	✓	✓	BMR 52X4 022 SOMT 1405	128,33 €
TK SOMT 14 005 KYCR	✓	✓	BMR 63X5 022 SOMT 1405	142,33 €
TK SOMT 14 006 KYCR	✓	✓	BMR 80X6 027 SOMT 1405	174,00 €
TK SOMT 14 008 KYCR	✓	✓	BMR 66X5 027 SOMT 1405	158,00 €

LOGU 0303 KYCR

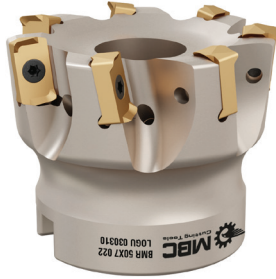

KOD	Stok Stock	Inter Cooland	Kesici Uç Uyumluluğu / Insert Suitability	FIYAT PRICE
			KYCR LOGU 030310	EURO
TK LOGU 03 001 KYCR	✓	✓	BMR 40X6 016 LOGU 030310	145,67 €
TK LOGU 03 002 KYCR	✓	✓	BMR 50X7 022 LOGU 030310	148,33 €
TK LOGU 03 004 KYCR	✓	✓	BMR 52X6 022 LOGU 030310	154,33 €
TK LOGU 03 005 KYCR	✓	✓	BMR 50X6 022 LOGU 030310	148,33 €

SPMW 1204 SNG

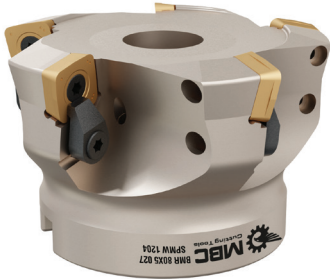

KOD	Stok Stock	Inter Cooland	Kesici Uç Uyumluluğu / Insert Suitability	FIYAT PRICE
			SNG SPMW 1204	EURO
TK SPMW 12 001 SNG	✓	✓	BMR 50X5 022 SPMW 1204	129,67 €
TK SPMW 12 002 SNG	✓	✓	BMR 80X5 027 SPMW 1204	170,00 €
TK SPMW 12 003 SNG	✓	✓	BMR 80X8 027 SPMW 1204	176,00 €
TK SPMW 12 004 SNG	✓	✓	BMR 100X8 032 SPMW 1204	194,67 €
TK SPMW 12 008 SNG	✓	✓	BMR 63X5 022 SPMW 1204	148,33 €
TK SPMW 12 009 SNG	✓	✓	BMR 52X5 022 SPMW 1204	140,33 €

SOMW 080315 SNG



KOD	Stok Stock	Inter Cooland	Kesici Uç Uyumluluğu / Insert Suitability	FIYAT PRICE
			SNG SOMW 080315	EURO
TK SOMW 08 001 SNG	✓	✓	BMR 40X5 016 SOMW 080315	114,33 €
TK SOMW 08 002 SNG	✓	✓	BMR 50X6 022 SOMW 080315	120,67 €
TK SOMW 08 003 SNG	✓	✓	BMR 63X7 022 SOMW 080315	142,00 €

WNMX 09T3/1305 KRLY

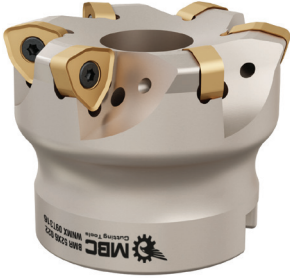

KOD	Stok Stock	Inter Cooland	Kesici Uç Uyumluluğu / Insert Suitability		FİYAT PRICE
			KRLY WNMX 09T3 / 1305		EURO
TK WNMX 09 002 KRLY	✓	✓	BMR 40X4 016 WNMX 09T316		114,33 €
TK WNMX 09 003 KRLY	✓	✓	BMR 50X4 022 WNMX 09T316		129,67 €
TK WNMX 09 004 KRLY	✓	✓	BMR 52X4 022 WNMX 09T316		129,67 €
TK WNMX 09 005 KRLY	✓	✓	BMR 52X5 022 WNMX 09T316		136,00 €
TK WNMX 09 006 KRLY	✓	✓	BMR 52X6 022 WNMX 09T316		136,00 €
TK WNMX 09 007 KRLY	✓	✓	BMR 63X5 022 WNMX 09T316		166,67 €
TK WNMX 09 008 KRLY	✓	✓	BMR 66X6 022 WNMX 09T316		166,67 €
TK WNMX 09 009 KRLY	✓	✓	BMR 66X6 027 WNMX 09T316		166,67 €
TK WNMX 09 010 KRLY	✓	✓	BMR 80X7 027 WNMX 09T316		185,33 €
TK WNMX 13 011 KRLY	✓	✓	BMR 63X4 022 WNMX 130520		158,00 €
TK WNMX 13 012 KRLY	✓	✓	BMR 80X5 027 WNMX 130520		173,00 €
TK WNMX 13 013 KRLY	✓	✓	BMR 52X4 022 WNMX 130520		120,67 €

LNMT 060310R KRLY

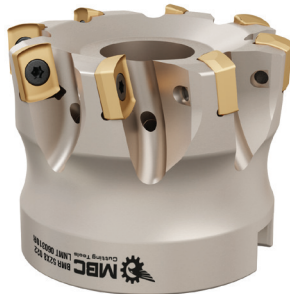

KOD	Stok Stock	Inter Cooland	Kesici Uç Uyumluluğu / Insert Suitability		FİYAT PRICE
			KRLY LNMT 060310R		EURO
TK LNMT 06 001 KRLY	✓	✓	BMR 40X6 016 LNMT 060310R		129,67 €
TK LNMT 06 002 KRLY	✓	✓	BMR 52X8 022 LNMT 060310R		151,33 €
TK LNMT 06 003 KRLY	✓	✓	BMR 63X9 022 LNMT 060310R		170,00 €
TK LNMT 06 004 KRLY	✓	✓	BMR 66X9 027 LNMT 060310R		170,00 €

LNMX 060310R KRLY



KOD	Stok Stock	Inter Cooland	Kesici Uç Uyumluluğu / Insert Suitability		FİYAT PRICE
			KRLY LNMX 060310		EURO
TK LNMX 06 001 KRLY	✓	✓	BMR 40X6 016 LNMX 060310		129,67 €
TK LNMX 06 002 KRLY	✓	✓	BMR 52X7 022 LNMX 060310		151,33 €
TK LNMX 06 003 KRLY	✓	✓	BMR 52X8 022 LNMX 060310		160,67 €
TK LNMX 06 005 KRLY	✓	✓	BMR 50x7 022 LNMX 060310		151,33 €
TK LNMX 06 006 KRLY	✓	✓	BMR 63x8 022 LNMX 060310		176,00 €
TK LNMX 06 007 KRLY	✓	✓	BMR 80x10 027 LNMX 060310		204,00 €

BLM 0603 TT



KOD	Stok Stock	Inter Cooland	Kesici Uç Uyumluluğu / Insert Suitability	FIYAT PRICE
			TT BLM 0603	EURO
TK BLM 06 001 TT	✓	✓	BMR 40X6 016 BLM 0603	117,67 €
TK BLM 06 002 TT	✓	✓	BMR 50X7 022 BLM 0603	136,00 €
TK BLM 06 003 TT	✓	✓	BMR 63X8 022 BLM 0603	152,67 €

LNMU 0303 TNGLY



KOD	Stok Stock	Inter Cooland	Kesici Uç Uyumluluğu / Insert Suitability	FIYAT PRICE
			TNGLY LNLMU 0303	EURO
TK LNLMU 03 001 TNG	✓	✓	BMR 40X6 016 LNLMU 0303	142,00 €
TK LNLMU 03 002 TNG	✓	✓	BMR 50X7 022 LNLMU 0303	166,67 €
TK LNLMU 03 003 TNG	✓	✓	BMR 63X8 022 LNLMU 0303	188,33 €
TK LNLMU 03 004 TNG	✓	✓	BMR 52X7 022 LNLMU 0303	166,67 €

XDPT 0904 WDA



KOD	Stok Stock	Inter Cooland	Kesici Uç Uyumluluğu / Insert Suitability	FIYAT PRICE
			WDA XDPT 0904	EURO
TK XDPT 09 001 WDA	✓	✓	BMR 40X5 016 XDPT 0904	120,67 €
TK XDPT 09 002 WDA	✓	✓	BMR 50X5 022 XDPT 0904	142,00 €
TK XDPT 09 003 WDA	✓	✓	BMR 50X6 022 XDPT 0904	151,33 €
TK XDPT 09 004 WDA	✓	✓	BMR 52X6 022 XDPT 0904	151,33 €

P26335 WLTR

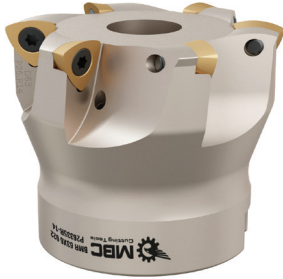

KOD	Stok Stock	Inter Cooland	Kesici Uç Uyumluluğu / Insert Suitability	FIYAT PRICE
			WLTR P26335R-10-14	EURO
TK P26335 001 WLTR	✓	✓	BMR 50X5 022 P26335R-14	129,67 €
TK P26335 002 WLTR	✓	✓	BMR 52X5 022 P26335R-14	129,67 €
TK P26335 003 WLTR	✓	✓	BMR 63X6 022 P26335R-14	151,33 €
TK P26335 004 WLTR	✗	✓	BMR 52X3 022 P26335R-25	120,67 €

UNEU 1307R INGRSL



KOD	Stok Stock	Inter Cooland	Kesici Uç Uyumluluğu / Insert Suitability	FIYAT PRICE
			INGRSL UNEU 1307R	EURO
TK UNEU 13 001 INGRSL	✓	✓	BMR 52X3 022 UNEU 1307R	120,67 €
TK UNEU 13 002 INGRSL	✓	✓	BMR 63X4 022 UNEU 1307R	142,00 €

RPMT 10T3 KYCR



KOD	Stok Stock	Inter Cooland	Kesici Uç Uyumluluğu / Insert Suitability	FIYAT PRICE
			KYCR RPMT 10T3	EURO
TK RPMT 10 002 KYCR	✓	✓	EMR 40X5 016 RPMT 10T3	92,67 €
TK RPMT 10 003 KYCR	✓	✓	EMR 50X6 022 RPMT 10T3	111,33 €

RPMT 1204 KYCR



KOD	Stok Stock	Inter Cooland	Kesici Uç Uyumluluğu / Insert Suitability	FIYAT PRICE
			KYCR RPMT 1204	EURO
TK RPMT 12 001 KYCR	✓	✓	EMR 40X4 016 RPMT 1204	89,67 €
TK RPMT 12 003 KYCR	✓	✓	EMR 52X5 022 RPMT 1204	111,33 €
TK RPMT 12 004 KYCR	✓	✓	EMR 63X6 022 RPMT 1204	129,67 €
TK RPMT 12 006 KYCR	✗	✓	EMR 66X6 027 RPMT 1204	139,00 €

RDKW 1003/12T3/1204 1604/2006 ISO



KOD	Stok Stock	Inter Cooland	Kesici Uç Uyumluluğu / Insert Suitability	FIYAT PRICE
			ISO RDKW 1003/12T3/1204/1604/2006	EURO
TK RD..10 001 ISO	✓	✓	EMR 40X4 016 RDKW 1003	83,67 €
TK RD..10 002 ISO	✓	✓	EMR 50X5 022 RDKW 1003	99,00 €
TK RD..10 003 ISO	✓	✓	EMR 63X6 022 RDKW 1003	129,67 €
TK RD..10 004 ISO	✓	✓	EMR 80X7 027 RDKW 1003	151,33 €
TK RD..10 005 ISO	✓	✓	EMR 100X8 032 RDKW 1003	166,67 €
TK RD..12 006 ISO	✓	✓	EMR 40X4 016 RDKW 12T3	83,67 €
TK RD..12 007 ISO	✓	✓	EMR 50X5 022 RDKW 12T3	99,00 €
TK RD..12 008 ISO	✓	✓	EMR 52X5 022 RDKW 12T3	102,00 €
TK RD..12 009 ISO	✓	✓	EMR 63X6 022 RDKW 12T3	129,67 €
TK RD..12 010 ISO	✓	✓	EMR 80X7 027 RDKW 12T3	151,33 €
TK RD..12 011 ISO	✓	✓	EMR 100X8 032 RDKW 12T3	166,67 €
TK RD..12 012 ISO	✓	✓	EMR 40X4 016 RDKW 1204	83,67 €
TK RD..12 013 ISO	✓	✓	EMR 50X5 022 RDKW 1204	99,00 €
TK RD..12 014 ISO	✓	✓	EMR 63X6 022 RDKW 1204	129,67 €
TK RD..12 015 ISO	✓	✓	EMR 80X7 027 RDKW 1204	151,33 €
TK RD..12 016 ISO	✓	✓	EMR 100X8 032 RDKW 1204	166,67 €
TK RD..12 017 ISO	✓	✗	EMR 125X9 040 RDKW 1204	278,00 €
TK RD..12 027 ISO	✓	✗	EMR 125X9 040 RDKW 12T3	241,00 €
TK RD..12 028 ISO	✓	✗	EMR 160X10 040 RDKW 12T3	333,33 €
TK RD..16 016 ISO	✓	✓	EMR 50X4 022 RDKW 1604	99,00 €
TK RD..16 017 ISO	✓	✓	EMR 52X4 022 RDKW 1604	99,00 €
TK RD..16 018 ISO	✓	✓	EMR 63X4 022 RDKW 1604	129,67 €
TK RD..16 019 ISO	✓	✓	EMR 66X5 027 RDKW 1604	129,67 €
TK RD..16 020 ISO	✓	✓	EMR 80X5 027 RDKW 1604	151,33 €
TK RD..16 021 ISO	✓	✓	EMR 100X6 032 RDKW 1604	166,67 €
TK RD..16 022 ISO	✓	✗	EMR 125X7 040 RDKW 1604	241,00 €
TK RD..16 023 ISO	✓	✗	EMR 160X8 040 RDKW 1604	278,00 €

RDKW 10T3 ISO



KOD	Stok Stock	Inter Cooland	Kesici Uç Uyumluluğu / Insert Suitability	FIYAT PRICE
			ISO RDKW 10T3	EURO
TK RDKW 10 001 ISO	✓	✓	EMR 50X5 022 RDKW 10T3	99,00 €
TK RDKW 10 002 ISO	✓	✓	EMR 63X6 022 RDKW 10T3	129,67 €
TK RDKW 10 003 ISO	✓	✓	EMR 80X7 027 RDKW 10T3	151,33 €

RPMT 1204 ISO



KOD	Stok Stock	Inter Cooland	Kesici Uç Uyumluluğu / Insert Suitability	FIYAT PRICE
			ISO RPMT 1204	EURO
TK RPMT 12 001 ISO	✓	✓	EMR 40X4 016 RPMT 1204	89,67 €
TK RPMT 12 002 ISO	✓	✓	EMR 50X5 022 RPMT 1204	111,33 €
TK RPMT 12 003 ISO	✓	✓	EMR 52X5 022 RPMT 1204	111,33 €
TK RPMT 12 004 ISO	✓	✓	EMR 63X6 027 RPMT 1204	129,67 €
TK RPMT 12 005 ISO	✓	✓	EMR 80X7 027 RPMT 1204	157,67 €
TK RP. 12 002 ZCC	✓	✓	EMR 50X5 022 RP. 1204	111,33 €

RPMW 1003 ISO



KOD	Stok Stock	Inter Cooland	Kesici Uç Uyumluluğu / Insert Suitability	FIYAT PRICE
			ISO RPMW 1003	EURO
TK RPMW 10 001 ISO	✓	✓	EMR 40X4 016 RPMW 1003	89,67 €
TK RPMW 10 002 ISO	✓	✓	EMR 50X5 022 RPMW 1003	105,33 €
TK RPMW 10 003 ISO	✓	✓	EMR 63X6 022 RPMW 1003	117,67 €
TK RPMW 10 004 ISO	✓	✓	EMR 80X7 027 RPMW 1003	154,33 €

RPMT 1204 TNGLY



KOD	Stok Stock	Inter Cooland	Kesici Uç Uyumluluğu / Insert Suitability	FIYAT PRICE
			TNGLY RPMT 1204	EURO
TK RPMT 12 001 TNG	✓	✓	EMR 40X4 016 RPMT 1204	89,67 €
TK RPMT 12 002 TNG	✓	✓	EMR 50X5 022 RPMT 1204	111,33 €
TK RPMT 12 003 TNG	✓	✓	EMR 63X6 022 RPMT 1204	129,67 €

RPMT 10T3 TNGLY



KOD	Stok Stock	Inter Cooland	Kesici Uç Uyumluluğu / Insert Suitability	FIYAT PRICE
			TNGLY RPMT 10T3	EURO
TK RPMT 10T 001 TNG	✓	✓	EMR 40X4 016 RPMT 10T3	102,00 €
TK RPMT 10T 002 TNG	✓	✓	EMR 50X5 022 RPMT 10T3	114,33 €
TK RPMT 10T 003 TNG	✓	✓	EMR 63X6 022 RPMT 10T3	132,67 €

RCKT 1204/1606 ZCC



KOD	Stok Stock	Inter Cooland	Kesici Uç Uyumluluğu / Insert Suitability	FIYAT PRICE
			ISO RCKT 1204/1606	EURO
TK RCKT 12 000 ISO	✓	✓	EMR 40X4 016 RCKT 1204	89,67 €
TK RCKT 12 001 ISO	✓	✓	EMR 50X5 022 RCKT 1204	102,00 €
TK RCKT 12 002 ISO	✓	✓	EMR 63X6 022 RCKT 1204	129,67 €
TK RCKT 16 005 ISO	✓	✓	EMR 80X5 027 RCKT 1606	154,33 €
TK RCKT 12 006 ISO	✓	✓	EMR 80X7 027 RCKT 1204	151,33 €

ROMX 2006 WLTR



KOD	Stok Stock	Inter Cooland	Kesici Uç Uyumluluğu / Insert Suitability	FIYAT PRICE
			WLTR ROMX 2006	EURO
TK ROMX 20 003 WLTR	✓	✗	EMR 125X6 040 ROMX 2006	241,00 €
TK ROMX 20 004 WLTR	✓	✗	EMR 160X7 040 ROMX 2006	278,00 €
TK ROMX 20 005 WLTR	✓	✗	EMR 200X9 060 ROMX 2006	401,33 €



VIDALI TARAMALAR SCREW TYPE

90° AP..1003/1604 ISO



KOD	Stok Stock	Inter Cooland	Kesici Uç Uyumluluğu / Insert Suitability		FIYAT PRICE
			ISO AP.. 1003/1604		EURO
VT AP..10 001 ISO	✓	X	VT EM90 25X3 M12 AP.1003		111,33 €
VT AP..10 002 ISO	✓	X	VT EM90 32X4 M16 AP.1003		117,67 €
VT AP..10 003 ISO	✓	X	VT EM90 35X4 M16 AP.1003		120,67 €
VT AP..10 005 ISO	✓	X	VT EM90 40X5 M16 AP.1003		126,67 €
VT AP..10 007 ISO	✓	X	VT EM90 16X2 M08 AP.1003		100,33 €
VT AP..10 008 ISO	✓	X	VT EM90 20X3 M10 AP.1003		102,00 €
VT AP..16 007 ISO	✓	X	VT EM90 25X2 M12 AP.1604		111,33 €
VT AP..16 008 ISO	✓	X	VT EM90 32X3 M16 AP.1604		120,67 €
VT AP..16 009 ISO	✓	X	VT EM90 40X4 M16 AP.1604		126,67 €

90° APMT 11T3



KOD	Stok Stock	Inter Cooland	Kesici Uç Uyumluluğu / Insert Suitability		FIYAT PRICE
			APMT 11T3		EURO
VT APMT 11 001	✓	X	VT EM90 20X3 M10 APMT 11T3		108,33 €
VT APMT 11 003	✓	X	VT EM90 25X4 M12 APMT 11T3		114,33 €
VT APMT 11 004	✓	X	VT EM90 32X4 M16 APMT 11T3		123,33 €

90° XNEX 0403 SCO



KOD	Stok Stock	Inter Cooland	Kesici Uç Uyumluluğu / Insert Suitability		FIYAT PRICE
			SCO XNEX 0403		EURO
VT XNEX 04 000 SCO	✓	✓	VT EM90 25X4 M12 XNEX 0403		126,67 €
VT XNEX 04 001 SCO	✓	✓	VT EM90 32X5 M16 XNEX 0403		136,00 €
VT XNEX 04 003 SCO	✓	✓	VT EM90 32X4 M16 XNEX 0403		111,33 €

90° XOMX 1204 SCO



KOD	Stok Stock	Inter Cooland	Kesici Uç Uyumluluğu / Insert Suitability	FIYAT PRICE
			SCO XOMX 1204..	EURO
VT XOMX 12 001 SCO (S)	✓	✓	VT EM90 25X3 M12 XOMX 1204 inter cooland	114,33 €
VT XOMX 12 002 SCO (S)	✓	✓	VT EM90 32X4 M16 XOMX 1204 inter cooland	120,67 €

90° 3PKT 1004 TT



KOD	Stok Stock	Inter Cooland	Kesici Uç Uyumluluğu / Insert Suitability	FIYAT PRICE
			TT 3PKT 1004	EURO
VT 3PKT 10 002 TT	✓	✗	VT EM90 32X4 M16 3PKT 1004	129,67 €
VT 3PKT 10 004 TT	✓	✗	VT EM90 42X4 M16 3PKT 1004	145,33 €

90° BOMT 1304 INGRSL



KOD	Stok Stock	Inter Cooland	Kesici Uç Uyumluluğu / Insert Suitability	FIYAT PRICE
			INGRSL BOMT 1304	EURO
VT BOMT 13 001 INGRSL	✓	✗	VT EM90 25X3 M12 BOMT 1304	111,33 €
VT BOMT 13 002 INGRSL	✓	✗	VT EM90 32X4 M16 BOMT 1304	120,67 €

90° AOMT 1605 INGRSL



KOD	Stok Stock	Inter Cooland	Kesici Uç Uyumluluğu / Insert Suitability		FIYAT PRICE
			INGRSL AOMT 160508		EURO
VT AOMT 16 001 INGRSL	✓	X	VT EM90 25X2 M12 AOMT 1605		111,33 €
VT AOMT 16 002 INGRSL	✓	X	VT EM90 32X3 M16 AOMT 1605		120,67 €
VT AOMT 16 003 INGRSL	✓	X	VT EM90 40X4 M16 AOMT 1605		126,67 €

90° TNGX 1004 PRMT



KOD	Stok Stock	Inter Cooland	Kesici Uç Uyumluluğu / Insert Suitability		FIYAT PRICE
			PRMT TNGX 1004		EURO
VT TNGX 10 001 PRMT	✓	✓	VT EM90 25X4 M12 TNGX 1004		120,67 €
VT TNGX 10 002 PRMT	✓	✓	VT EM90 32X5 M16 TNGX 1004		139,00 €

90° APMT 1135 SNG



KOD	Stok Stock	Inter Cooland	Kesici Uç Uyumluluğu / Insert Suitability		FIYAT PRICE
			SNG APMT 1135		EURO
VT APMT 11 003 SNG	✓	✓	VT EM90 25X3 M12 APMT 1135		111,33 €
VT APMT 11 004 SNG	✓	✓	VT EM90 32X4 M16 APMT 1135		120,67 €

90° XDKT 1505 CRTZT



KOD	Stok Stock	Inter Cooland	Kesici Uç Uyumluluğu / Insert Suitability		FIYAT PRICE
			CRTZ XDKT 1505		EURO
VT XDKT 15 001 CRTZ	✓	X	VT EM90 25X2 M12 XDKT 1505		111,33 €
VT XDKT 15 002 CRTZ	✓	X	VT EM90 32X3 M16 XDKT 1505		119,00 €

90° XDHT 1904 CRTZT



KOD	Stok Stock	Inter Cooland	Kesici Uç Uyumluluğu / Insert Suitability		FIYAT PRICE
			CRTZ XDHT 1904		EURO
VT XDHT 19 001 CRTZ	✓	X	VT EM90 25X2 M12 XDHT 1904		111,33 €
VT XDHT 19 002 CRTZ	✓	X	VT EM90 40X4 M16 XDHT 1904		129,67 €

90° APMT 11T308 KRLY



KOD	Stok Stock	Inter Cooland	Kesici Uç Uyumluluğu / Insert Suitability		FIYAT PRICE
			KRLY APMT 11T308		EURO
VT APMT 11 001 KRLY	✓	✓	VT EM90 20X3 M10 APMT 11T308		108,33 €
VT APMT 11 003 KRLY	✓	✓	VT EM90 32X4 M16 APMT 11T308		123,33 €

90° XNKT 0604 KRLY



90° XNKT 0805 KRLY



90° 4NKT 0603 TT



RD..1003/12T3/1604 ISO



KOD	Stok Stock	Inter Cooland	Kesici Uç Uyumluluğu / Insert Suitability		FIYAT PRICE
			KRLY XNKT 0604		EURO
VT XNKT 06 001 KRLY	✓	✓	VT EM90 25X3 M12 XNKT 0604		126,67 €
VT XNKT 06 002 KRLY	✓	✓	VT EM90 32X4 M16 XNKT 0604		136,00 €
VT XNKT 06 004 KRLY	✓	✓	VT EM90 42X5 M16 XNKT 0604		145,33 €
VT XNKT 06 006 KRLY	✓	✓	VT EM90 20X2 M10 XNKT 0604		120,67 €

KOD	Stok Stock	Inter Cooland	Kesici Uç Uyumluluğu / Insert Suitability		FIYAT PRICE
			KRLY XNKT 0805		EURO
VT XNKT 08 001 KRLY	✓	✓	VT EM90 32X3 M16 XNKT 0805		136,00 €
VT XNKT 08 002 KRLY	✓	✓	VT EM90 40X4 M16 XNKT 0805		145,33 €
VT XNKT 08 003 KRLY	✓	✓	VT EM90 42X4 M16 XNKT 0805		148,33 €

KOD	Stok Stock	Inter Cooland	Kesici Uç Uyumluluğu / Insert Suitability		FIYAT PRICE
			TT 4NKT 0603		EURO
VT 4NKT 06 004 TT	✓	✓	VT EM90 21X3 M10 4NKT 0603		132,67 €
VT 4NKT 06 005 TT	✓	✓	VT EM90 26X3 M12 4NKT 0603		126,67 €
VT 4NKT 06 006 TT	✓	✓	VT EM90 32X4 M16 4NKT 0603		145,33 €

KOD	Stok Stock	Inter Cooland	Kesici Uç Uyumluluğu / Insert Suitability		FIYAT PRICE
			ISO RD.. 1003/12T3/1604		EURO
VT RD..10 001 ISO	✓	✓	VT EMR 25X2 M12 RD..1003		102,00 €
VT RD..10 003 ISO	✓	✓	VT EMR 32X4 M16 RD..1003		114,33 €
VT RD..10 004 ISO	✓	✓	VT EMR 35X4 M16 RD..1003		117,67 €
VT RD..10 005 ISO	✓	✓	VT EMR 40X4 M16 RD..1003		120,67 €
VT RD..10 006 ISO	✓	✓	VT EMR 42X5 M16 RD..1003		123,33 €
VT RD..10 007 ISO	✓	✓	VT EMR 20X2 M10 RD..1003		96,00 €
VT RD..12 007 ISO	✓	✓	VT EMR 25X2 M12 RD..12T3		105,33 €
VT RD..12 008 ISO	✓	✓	VT EMR 32X3 M16 RD..12T3		114,33 €
VT RD..12 009 ISO	✓	✓	VT EMR 35X3 M16 RD..12T3		114,33 €
VT RD..12 011 ISO	✓	✓	VT EMR 42X4 M16 RD..12T3		123,33 €
VT RD..16 012 ISO	✓	✓	VT EMR 32X2 M16 RD..1604		114,33 €
VT RD..16 013 ISO	✓	✓	VT EMR 40X2 M16 RD..1604		120,67 €
VT RD..08 017 ISO	✓	✓	VT EMR 16X2 M8 RD..0803		86,67 €

RPMW 1003 ISO



KOD	Stok Stock	Inter Cooland	Kesici Uç Uyumluluğu / Insert Suitability	FIYAT PRICE
			ISO RPMW 1003	EURO
VT RPMW 10 001 ISO	✓	✓	VT EMR 20X2 M10 RPMW 1003	111,33 €
VT RPMW 10 002 ISO	✓	✓	VT EMR 25X2 M12 RPMW 1003	114,33 €
VT RPMW 10 003 ISO	✓	✓	VT EMR 32X4 M16 RPMW 1003	120,67 €
VT RPMW 10 004 ISO	✓	✓	VT EMR 42X5 M16 RPMW 1003	129,67 €

RDHX 1003 KYCR



KOD	Stok Stock	Inter Cooland	Kesici Uç Uyumluluğu / Insert Suitability	FIYAT PRICE
			KYCR RDHX 1003	EURO
VT RDHX 10 001 KYCR	✓	✓	VT EMR 32X4 M16 RDHX 1003	114,33 €
VT RDHX 10 002 KYCR	✓	✓	VT EMR 42X5 M16 RDHX 1003	120,67 €

RPMT 10T3 KYCR



KOD	Stok Stock	Inter Cooland	Kesici Uç Uyumluluğu / Insert Suitability	FIYAT PRICE
			RPMT KYCR 10T3	EURO
VT RPMT 10 001 KYCR	✓	✓	VT EMR 25X3 M12 RPMT 10T3	102,00 €
VT RPMT 10 003 KYCR	✓	✓	VT EMR 32X4 M16 RPMT 10T3	117,67 €
VT RPMT 10 006 KYCR	✓	✓	VT EMR 42X5 M16 RPMT 10T3	129,67 €

RPMT 1204 KYCR



KOD	Stok Stock	Inter Cooland	Kesici Uç Uyumluluğu / Insert Suitability		FIYAT PRICE
			RPMT KYCR 1204		EURO
VT RPMT 12 001 KYCR	X	✓	VT EMR 25X2 M12 RPMT 1204		99,00 €
VT RPMT 12 002 KYCR	X	✓	VT EMR 32X3 M16 RPMT 1204		117,67 €

ROHX 1203/1604 ZCC



KOD	Stok Stock	Inter Cooland	Kesici Uç Uyumluluğu / Insert Suitability		FIYAT PRICE
			ZCC ROHX 1203/1604		EURO
VT ROHX 16 002 ZCC	✓	X	VT EMR D16 M8 ROHX 1604		136,00 €
VT ROHX 20 003 ZCC	✓	X	VT EMR D20 M10 ROHX 2005		142,00 €

XPHT 32 R16 ZCC



KOD	Stok Stock	Inter Cooland	Kesici Uç Uyumluluğu / Insert Suitability		FIYAT PRICE
			ZCC XPHT 32 R16		EURO
VT XPHT 25 001 ZCC	✓	✓	VT EMR 25X2 M12 XPHT 25 R12.5		102,00 €
VT XPHT 32 002 ZCC	✓	✓	VT EMR 32X2 M16 XPHT 32 R16		111,33 €

SDMT 06T2/09T3/1204 ZCC



KOD	Stok Stock	Inter Cooland	Kesici Uç Uyumluluğu / Insert Suitability	FIYAT PRICE
			ZCC SDMT 06T2/09T3/1204	EURO
VT SDMT 09 003 ZCC	✓	✓	VT BMR 25X2 M12 SDMT 09T3	103,67 €
VT SDMT 09 004 ZCC	✓	✓	VT BMR 25X3 M12 SDMT 09T3	103,67 €
VT SDMT 09 005 ZCC	✓	✓	VT BMR 32X3 M16 SDMT 09T3	114,33 €
VT SDMT 09 006 ZCC	✓	✓	VT BMR 35X4 M16 SDMT 09T3	117,67 €
VT SDMT 09 007 ZCC	✓	✓	VT BMR 40X4 M16 SDMT 09T3	126,67 €
VT SDMT 09 009 ZCC	✓	✓	VT BMR 42X5 M16 SDMT 09T3	126,67 €

SOEW 0803 PLBT



KOD	Stok Stock	Inter Cooland	Kesici Uç Uyumluluğu / Insert Suitability	FIYAT PRICE
			PLBT SOEW 0803	EURO
VT SOEW 08 001 PLBT	✓	✓	VT BMR 32X4 M16 SOEW 0803	114,33 €
VT SOEW 08 002 PLBT	✓	✓	VT BMR 35X4 M16 SOEW 0803	117,67 €
VT SOEW 08 003 PLBT	✓	✓	VT BMR 40X5 M16 SOEW 0803	123,33 €
VT SOEW 08 004 PLBT	✓	✓	VT BMR 25X3 M12 SOEW 0803	111,33 €

SDMX 09T3 PLBT



KOD	Stok Stock	Inter Cooland	Kesici Uç Uyumluluğu / Insert Suitability	FIYAT PRICE
			PLBT SDMX 09T312	EURO
VT SDMX 09 001 PLBT	✓	✓	VT BMR 25X3 M12 SDMX 09T3	111,33 €
VT SDMX 09 003 PLBT	✓	✓	VT BMR 32X4 M16 SDMX 09T3	117,67 €
VT SDMX 09 004 PLBT	✓	✓	VT BMR 35X5 M16 SDMX 09T3	120,67 €
VT SDMX 09 005 PLBT	✓	✓	VT BMR 42X6 M16 SDMX 09T3	132,67 €

XDHW 04/06/09 PLBT



KOD	Stok Stock	Inter Cooland	Kesici Uç Uyumluluğu / Insert Suitability	FİYAT PRICE
			PLBT - VNDRT XDHW 04/06/09	EURO
VT XDHW 04 003 PLBT			VT BMR 16X4 M08 XDHW 0401	111,33 €
VT XDHW 06 001 PLBT	✓	✓	VT BMR 16X2 M08 XDHW 0602	105,33 €
VT XDHW 06 003 PLBT	✓	✓	VT BMR 32X5 M16 XDHW 0602	129,67 €
VT XDHW 06 004 PLBT	✓	✓	VT BMR 35X5 M16 XDHW 0602	129,67 €
VT XDHW 06 005 PLBT	✓	✓	VT BMR 20X3 M10 XDHW 0602	111,33 €
VT XDHW 06 006 PLBT	✓	✓	VT BMR 42X6 M16 XDHW 0602	132,67 €
VT XDHW 06 007 PLBT	✓	✓	VT BMR 25X4 M12 XDHW 0602	120,67 €
VT XDHW 06 008 PLBT	✓	✓	VT BMR 17X2 M08 XDHW 0602	105,33 €
VT XDHW 06 009 PLBT	✓	✓	VT BMR 21X3 M10 XDHW 0602	111,33 €

SEMT 09T307 PLBT



KOD	Stok Stock	Inter Cooland	Kesici Uç Uyumluluğu / Insert Suitability	FİYAT PRICE
			SEMT 09T307	EURO
VT SEMT 09T3 002	✗	✓	VT BMR 35X4 M16 SEMT 09T307	117,67 €
VT SEMT 09T3 003	✗	✓	VT BMR 42X5 M16 SEMT 09T307	126,67 €

XCNT 09T3 LMT FT



KOD	Stok Stock	Inter Cooland	Kesici Uç Uyumluluğu / Insert Suitability	FİYAT PRICE
			LMT XCNT 09T3	EURO
VT XCNT 09 002 LMT FT	✗	✓	VT BMR 32X4 M16 XCNT 09T3	120,67 €
VT XCNT 09 003 LMT FT	✗	✓	VT BMR 42X4 M16 XCNT 09T3	139,00 €

WNMX 09T3 KRLY



KOD	Stok Stock	Inter Cooland	Kesici Uç Uyumluluğu / Insert Suitability	FIYAT PRICE
			KRLY WNMX 09T316	EURO
VT WNMX 09 001 KRLY	✓	✓	VT BMR 25X2 M12 WNMX 09T3	103,67 €
VT WNMX 09 002 KRLY	✓	✓	VT BMR 32X3 M16 WNMX 09T3	120,67 €
VT WNMX 09 004 KRLY	✓	✓	VT BMR 35X4 M16 WNMX 09T3	126,67 €
VT WNMX 09 005 KRLY	✓	✓	VT BMR 40X4 M16 WNMX 09T3	134,67 €
VT WNMX 09 006 KRLY	✓	✓	VT BMR 42X4 M16 WNMX 09T3	139,00 €

WNMX 0603 KRLY



KOD	Stok Stock	Inter Cooland	Kesici Uç Uyumluluğu / Insert Suitability	FIYAT PRICE
			KRLY WNMX 0603	EURO
VT WNMX 06 001 KRLY	✓	✓	VT BMR 16X2 M08 WNMX 0603	99,00 €
VT WNMX 06 002 KRLY	✓	✓	VT BMR 20X3 M10 WNMX 0603	114,33 €
VT WNMX 06 003 KRLY	✓	✓	VT BMR 25X3 M12 WNMX 0603	120,67 €
VT WNMX 06 004 KRLY	✓	✓	VT BMR 25X4 M12 WNMX 0603	123,33 €
VT WNMX 06 005 KRLY	✓	✓	VT BMR 35X5 M16 WNMX 0603	132,67 €
VT WNMX 06 006 KRLY	✓	✓	VT BMR 32X5 M16 WNMX 0603	132,67 €

LNMT 0603 KRLY



KOD	Stok Stock	Inter Cooland	Kesici Uç Uyumluluğu / Insert Suitability	FIYAT PRICE
			KRLY LNMT 060310	EURO
VT LNMT 06 002 KRLY	✓	✓	VT BMR 35X5 M16 LN..0603	123,33 €
VT LNMT 06 003 KRLY	✓	✓	VT BMR 40X6 M16 LN..0603	142,00 €

LNMX 060310 KRLY



KOD	Stok Stock	Inter Cooland	Kesici Uç Uyumluluğu / Insert Suitability	FİYAT PRICE
			KRLY LNMX 0603	EURO
VT LNMX 06 001 KRLY	✓	✓	VT BMR 16X2 M8 LNMX 0603	108,33 €
VT LNMX 06 002 KRLY	✓	✓	VT BMR 20X3 M10 LNMX 0603	108,33 €
VT LNMX 06 003 KRLY	✓	✓	VT BMR 25X4 M12 LNMX 0603	114,33 €
VT LNMX 06 004 KRLY	✓	✓	VT BMR 35X5 M16 LNMX 0603	123,33 €
VT LNMX 06 005 KRLY	✓	✓	VT BMR 42X6 M16 LNMX 0603	142,00 €
VT LNMX 06 006 KRLY	✓	✓	VT BMR 32X5 M16 LNMX 0603	123,33 €
VT LNMX 06 007 KRLY	✓	✓	VT BMR 40X6 M16 LNMX 0603	142,00 €
VT LNMX 06 008 KRLY	✓	✓	VT BMR 17X2 M08 LNMX 0603	108,33 €
VT LNMX 06 009 KRLY	✓	✓	VT BMR 21X3 M10 LNMX 0603	108,33 €
VT LNMX 06 010 KRLY	✓	✓	VT BMR 26X4 M12 LNMX 0603	114,33 €

BLM. 0603 TT



KOD	Stok Stock	Inter Cooland	Kesici Uç Uyumluluğu / Insert Suitability	FİYAT PRICE
			TT BLM. 0603	EURO
VT BLM 06 001 TT	✓	✓	VT BMR 32X5 M16 BLMP 0603	131,33 €
VT BLM 06 002 TT	✓	✓	VT BMR 42X6 M16 BLMP 0603	154,33 €
VT BLM 06 003 TT	✓	✓	VT BMR 20X3 M10 BLMP 0603	120,67 €
VT BLM 06 004 TT	✓	✓	VT BMR 25X4 M12 BLMP 0603	126,67 €
VT BLM 06 005 TT	✓	✓	VT BMR 40X6 M16 BLMP 0603	151,33 €

SOMT 1004/1404 KYCR



KOD	Stok Stock	Inter Cooland	Kesici Uç Uyumluluğu / Insert Suitability	FİYAT PRICE
			KYCR SOMT 1004/1404	EURO
VT SOMT 10 001 KYCR	✓	✓	VT BMR 32X3 M16 SOMT 10	117,67 €
VT SOMT 10 002 KYCR	✓	✓	VT BMR 35X3 M16 SOMT 10	117,67 €
VT SOMT 10 003 KYCR	✓	✓	VT BMR 40X4 M16 SOMT 10	126,67 €
VT SOMT 10 004 KYCR	✓	✓	VT BMR 42X4 M16 SOMT 10	126,67 €
VT SOMT 14 005 KYCR	✓	✓	VT BMR 42X3 M16 SOMT 14	132,67 €

LOGU 0303 KYCR



KOD	Stok Stock	Inter Cooland	Kesici Uç Uyumluluğu / Insert Suitability	FIYAT PRICE
			KYCR LOGU 0303	EURO
VT LOGU 03 001 KYCR	✓	✓	VT BMR 20X3 M10 LOGU 0303	132,67 €
VT LOGU 03 002 KYCR	✓	✓	VT BMR 25X4 M12 LOGU 0303	139,00 €
VT LOGU 03 003 KYCR	✓	✓	VT BMR 32X5 M16 LOGU 0303	145,33 €
VT LOGU 03 004 KYCR	✓	✓	VT BMR 40X6 M16 LOGU 0303	151,33 €
VT LOGU 03 005 KYCR	✓	✓	VT BMR 42X6 M16 LOGU 0303	151,33 €
VT LOGU 03 006 KYCR	✓	✓	VT BMR 35X5 M16 LOGU 0303	145,33 €
VT LOGU 03 007 KYCR	✓	✓	VT BMR 17X2 M8 LOGU 0303	114,33 €

P26335 R10/R14 WLTR



KOD	Stok Stock	Inter Cooland	Kesici Uç Uyumluluğu / Insert Suitability	FIYAT PRICE
			WLTR P26335 R10/R14	EURO
VT P2633 R10 004 WLTR	✓	✓	VT BMR 40X5 M16 P26..R-10	136,00 €
VT P2633 R14 002 WLTR	✗	✗	VT BMR 32X3 M16 P26..R-14	114,33 €

LNMU 0303 TNG



KOD	Stok Stock	Inter Cooland	Kesici Uç Uyumluluğu / Insert Suitability	FIYAT PRICE
			TNGLY LNMU 0303	EURO
VT LNMU 03 001 TNG	✓	✓	VT BMR 25X4 M12 LNMU 0303	142,00 €
VT LNMU 03 002 TNG	✓	✓	VT BMR 32X5 M16 LNMU 0303	151,33 €
VT LNMU 03 004 TNG	✓	✓	VT BMR 40X6 M16 LNMU 0303	154,33 €
VT LNMU 03 005 TNG	✓	✓	VT BMR 20X3 M10 LNMU 0303	129,67 €
VT LNMU 03 006 TNG	✓	✓	VT BMR 32X4 M16 LNMU 0303	151,33 €
VT LNMU 03 007 TNG	✓	✓	VT BMR 35X4 M16 LNMU 0303	151,33 €
VT LNMU 03 008 TNG	✓	✓	VT BMR 42X5 M16 LNMU 0303	163,67 €
VT LNMU 03 009 TNG	✓	✓	VT BMR 42X6 M16 LNMU 0303	163,67 €

BNGX 10T3 PRMT



KOD	Stok Stock	Inter Cooland	Kesici Uç Uyumluluğu / Insert Suitability	FIYAT PRICE
			PRMT BNGX 10T3	EURO
VT BNGX 10 001 PRMT	X	✓	VT BMR 25X4 M12 BNGX 10T3	120,67 €
VT BNGX 10 002 PRMT	X	✓	VT BMR 32X5 M16 BNGX 10T3	139,00 €

SDMT 1004 BHLR



KOD	Stok Stock	Inter Cooland	Kesici Uç Uyumluluğu / Insert Suitability	FIYAT PRICE
			BHLR SDMT 1004	EURO
VT SDMT 10 001 BHLR	✓	✓	VT BMR 32X3 M16 SDMT 1004	120,67 €
VT SDMT 10 002 BHLR	✓	✓	VT BMR 25X2 M12 SDMT 1004	111,33 €

SPMW 1204 SNG



KOD	Stok Stock	Inter Cooland	Kesici Uç Uyumluluğu / Insert Suitability	FIYAT PRICE
			SNG SPMW 1204	EURO
VT SPMW 12 001 SNG	✓	✓	VT BMR 32X2 M16 SPMW 1204	114,33 €
VT SPMW 12 002 SNG	✓	✓	VT BMR 40X3 M16 SPMW 1204	129,67 €

SOMW 080315 SNG



KOD	Stok Stock	Inter Cooland	Kesici Uç Uyumluluğu / Insert Suitability	FIYAT PRICE
			SNG SOMW 0803	EURO
VT SOMW 08 001 SNG	✓	✓	VT BMR 20X2 M10 SOMW 0803	102,00 €
VT SOMW 08 002 SNG	✓	✓	VT BMR 25X3 M12 SOMW 0803	111,33 €
VT SOMW 08 003 SNG	✓	✓	VT BMR 32X4 M16 SOMW 0803	120,67 €
VT SOMW 08 004 SNG	✓	✓	VT BMR 42X5 M16 SOMW 0803	129,67 €
VT SOMW 08 005 SNG	✓	✓	VT BMR 40X5 M16 SOMW 0803	129,67 €

XDHX 06/10 SNG



KOD	Stok Stock	Inter Cooland	Kesici Uç Uyumluluğu / Insert Suitability	FIYAT PRICE
			SNG XDHX 06/10	EURO
VT XDHX 06 001 SNG	✓	✓	VT BMR 20X3 M10 XDHX06	114,33 €
VT XDHX 06 002 SNG	✓	✓	VT BMR 25X4 M12 XDHX06	120,67 €
VT XDHX 10 004 SNG	✓	✓	VT BMR 35X3 M16 XDHX10	123,33 €

YNGX 0603 SNG



KOD	Stok Stock	Inter Cooland	Kesici Uç Uyumluluğu / Insert Suitability	FIYAT PRICE
			SNG YNGX 0603	EURO
VT YNGX 06 002 SNG	✓	✓	VT EM90 20X3 M10 YNGX 0603	132,67 €
VT YNGX 06 003 SNG	✓	✓	VT EM90 25X3 M12 YNGX 0603	139,00 €
VT YNGX 06 004 SNG	✓	✓	VT EM90 32X4 M16 YNGX 0603	145,33 €
VT YNGX 06 005 SNG	✓	✓	VT EM90 40X5 M16 YNGX 0603	151,33 €



U - DRILLER U - DRILLS

DRILL WCM. D2



KOD	Stok Stock	Inter Cooland	Kesici Uç Uyumluluğu / Insert Suitability	FİYAT PRICE
			WCM.	EURO
WCM D2 016 ISO	✓	✓	DRILL 16XD2 WCM 030208	145,00 €
WCM D2 016,5 ISO	✓	✓	DRILL 16,5XD2 WCM 030208	145,00 €
WCM D2 017 ISO	✓	✓	DRILL 17XD2 WCM 030208	145,00 €
WCM D2 017,5 ISO	✓	✓	DRILL 17,5XD2 WCM 030208	145,00 €
WCM D2 018 ISO	✓	✓	DRILL 18XD2 WCM 030208	145,00 €
WCM D2 018,5 ISO	✓	✓	DRILL 18,5XD2 WCM 030208	145,00 €
WCM D2 019 ISO	✓	✓	DRILL 19XD2 WCM 030208	145,00 €
WCM D2 019,5 ISO	✓	✓	DRILL 19,5XD2 WCM 030208	145,00 €
WCM D2 020 ISO	✓	✓	DRILL 20XD2 WCM 040208	149,33 €
WCM D2 020,5 ISO	✓	✓	DRILL 20,5XD2 WCM 040208	149,33 €
WCM D2 021 ISO	✓	✓	DRILL 21XD2 WCM 040208	149,33 €
WCM D2 021,5 ISO	✓	✓	DRILL 21,5XD2 WCM 040208	149,33 €
WCM D2 022 ISO	✓	✓	DRILL 22XD2 WCM 040208	149,33 €
WCM D2 022,5 ISO	✓	✓	DRILL 22,5XD2 WCM 040208	149,33 €
WCM D2 023 ISO	✓	✓	DRILL 23XD2 WCM 040208	149,33 €
WCM D2 023,5 ISO	✓	✓	DRILL 23,5XD2 WCM 040208	149,33 €
WCM D2 024 ISO	✓	✓	DRILL 24XD2 WCM 050308	158,33 €
WCM D2 024,5 ISO	✓	✓	DRILL 24,5XD2 WCM 050308	158,33 €
WCM D2 025 ISO	✓	✓	DRILL 25XD2 WCM 050308	158,33 €
WCM D2 025,5 ISO	✓	✓	DRILL 25,5XD2 WCM 050308	158,33 €
WCM D2 026 ISO	✓	✓	DRILL 26XD2 WCM 050308	158,33 €
WCM D2 026,5 ISO	✓	✓	DRILL 26,5XD2 WCM 050308	158,33 €
WCM D2 027 ISO	✓	✓	DRILL 27XD2 WCM 050308	158,33 €
WCM D2 027,5 ISO	✓	✓	DRILL 27,5XD2 WCM 050308	158,33 €
WCM D2 028 ISO	✓	✓	DRILL 28XD2 WCM 050308	158,33 €
WCM D2 028,5 ISO	✓	✓	DRILL 28,5XD2 WCM 050308	158,33 €
WCM D2 029 ISO	✓	✓	DRILL 29XD2 WCM 050308	158,33 €
WCM D2 029,5 ISO	✓	✓	DRILL 29,5XD2 WCM 050308	158,33 €
WCM D2 030 ISO	✓	✓	DRILL 30XD2 WCM 060308	179,33 €
WCM D2 031 ISO	✓	✓	DRILL 31XD2 WCM 06T308	179,33 €
WCM D2 032 ISO	✓	✓	DRILL 32XD2 WCM 06T308	179,33 €
WCM D2 033 ISO	✓	✓	DRILL 33XD2 WCM 06T308	179,33 €
WCM D2 034 ISO	✓	✓	DRILL 34XD2 WCM 06T308	179,33 €
WCM D2 035 ISO	✓	✓	DRILL 35XD2 WCM 06T308	179,33 €
WCM D2 036 ISO	✓	✓	DRILL 36XD2 WCM 06T308	179,33 €
WCM D2 037 ISO	✓	✓	DRILL 37XD2 WCM 06T308	179,33 €
WCM D2 038 ISO	✓	✓	DRILL 38XD2 WCM 06T308	179,33 €
WCM D2 039 ISO	✓	✓	DRILL 39XD2 WCM 06T308	179,33 €
WCM D2 040 ISO	✓	✓	DRILL 40XD2 WCM 06T308	179,33 €
WCM D2 041 ISO	✓	✓	DRILL 41XD2 WCM 06T308	185,33 €
WCM D2 042 ISO	✓	✓	DRILL 42XD2 WCM 06T308	185,33 €
WCM D2 043 ISO	✓	✓	DRILL 43XD2 WCM 06T308	185,33 €
WCM D2 044 ISO	✓	✓	DRILL 44XD2 WCM 06T308	185,33 €
WCM D2 045 ISO	✓	✓	DRILL 45XD2 WCM..080412	194,33 €
WCM D2 046 ISO	✓	✓	DRILL 46XD2 WCM..080412	209,00 €
WCM D2 047 ISO	✓	✓	DRILL 47XD2 WCM..080412	224,00 €
WCM D2 048 ISO	✓	✓	DRILL 48XD2 WCM..080412	233,00 €
WCM D2 049 ISO	✓	✓	DRILL 49XD2 WCM..080412	242,00 €
WCM D2 050 ISO	✓	✓	DRILL 50XD2 WCM..080412	254,00 €

DRILL WCM. D3



KOD	Stok Stock	Inter Cooland	Kesici Uç Uyumluluğu / Insert Suitability	FIYAT PRICE
			WCM.	EURO
WCM.D3 015,5 ISO	✓	✓	DRILL 15,5XD3 WCM 030208	155,33 €
WCM.D3 016 ISO	✓	✓	DRILL 16XD3 WCM 030208	155,33 €
WCM.D3 016,5 ISO	✓	✓	DRILL 16,5XD3 WCM 030208	155,33 €
WCM.D3 017 ISO	✓	✓	DRILL 17XD3 WCM 030208	155,33 €
WCM.D3 017,5 ISO	✓	✓	DRILL 17,5XD3 WCM 030208	155,33 €
WCM.D3 018 ISO	✓	✓	DRILL 18XD3 WCM 030208	155,33 €
WCM.D3 018,5 ISO	✓	✓	DRILL 18,5XD3 WCM 030208	155,33 €
WCM.D3 019 ISO	✓	✓	DRILL 19XD3 WCM 030208	155,33 €
WCM.D3 019,5 ISO	✓	✓	DRILL 19,5XD3 WCM 030208	155,33 €
WCM.D3 020 ISO	✓	✓	DRILL 20XD3 WCM 040208	164,33 €
WCM.D3 020,5 ISO	✓	✓	DRILL 20,5XD3 WCM 040208	164,33 €
WCM.D3 021 ISO	✓	✓	DRILL 21XD3 WCM 040208	164,33 €
WCM.D3 021,5 ISO	✓	✓	DRILL 21,5XD3 WCM 040208	164,33 €
WCM.D3 022 ISO	✓	✓	DRILL 22XD3 WCM 040208	164,33 €
WCM.D3 022,5 ISO	✓	✓	DRILL 22,5XD3 WCM 040208	164,33 €
WCM.D3 023 ISO	✓	✓	DRILL 23XD3 WCM 040208	164,33 €
WCM.D3 023,5 ISO	✓	✓	DRILL 23,5XD3 WCM 040208	164,33 €
WCM.D3 024 ISO	✓	✓	DRILL 24XD3 WCM 050308	167,33 €
WCM.D3 024,5 ISO	✓	✓	DRILL 24,5XD3 WCM 050308	167,33 €
WCM.D3 025 ISO	✓	✓	DRILL 25XD3 WCM 050308	167,33 €
WCM.D3 025,5 ISO	✓	✓	DRILL 25,5XD3 WCM 050308	167,33 €
WCM.D3 026 ISO	✓	✓	DRILL 26XD3 WCM 050308	167,33 €
WCM.D3 026,5 ISO	✓	✓	DRILL 26,5XD3 WCM 050308	167,33 €
WCM.D3 027 ISO	✓	✓	DRILL 27XD3 WCM 050308	167,33 €
WCM.D3 027,5 ISO	✓	✓	DRILL 27,5XD3 WCM 050308	167,33 €
WCM.D3 028 ISO	✓	✓	DRILL 28XD3 WCM 050308	167,33 €
WCM.D3 028,5 ISO	✓	✓	DRILL 28,5XD3 WCM 050308	167,33 €
WCM.D3 029 ISO	✓	✓	DRILL 29XD3 WCM 050308	167,33 €
WCM.D3 029,5 ISO	✓	✓	DRILL 29,5XD3 WCM 050308	167,33 €
WCM.D3 030 ISO	✓	✓	DRILL 30XD3 WCM 06T308	182,33 €
WCM.D3 030,5 ISO	✓	✓	DRILL 30,5XD3 WCM 06T308	182,33 €
WCM.D3 031 ISO	✓	✓	DRILL 31XD3 WCM 06T308	182,33 €
WCM.D3 031,5 ISO	✓	✓	DRILL 31,5XD3 WCM 06T308	182,33 €
WCM.D3 032 ISO	✓	✓	DRILL 32XD3 WCM 06T308	182,33 €
WCM.D3 032,5 ISO	✓	✓	DRILL 32,5XD3 WCM 06T308	182,33 €
WCM.D3 033 ISO	✓	✓	DRILL 33XD3 WCM 06T308	182,33 €
WCM.D3 033,5 ISO	✓	✓	DRILL 33,5XD3 WCM 06T308	182,33 €
WCM.D3 034 ISO	✓	✓	DRILL 34XD3 WCM 06T308	182,33 €
WCM.D3 034,5 ISO	✓	✓	DRILL 34,5XD3 WCM 06T308	182,33 €
WCM.D3 035 ISO	✓	✓	DRILL 35XD3 WCM 06T308	182,33 €
WCM.D3 035,5 ISO	✓	✓	DRILL 35,5XD3 WCM 06T308	182,33 €
WCM.D3 036 ISO	✓	✓	DRILL 36XD3 WCM 06T308	182,33 €
WCM.D3 036,5 ISO	✓	✓	DRILL 36,5XD3 WCM 06T308	182,33 €
WCM.D3 037 ISO	✓	✓	DRILL 37XD3 WCM 06T308	182,33 €
WCM.D3 037,5 ISO	✓	✓	DRILL 37,5XD3 WCM 06T308	182,33 €
WCM.D3 038 ISO	✓	✓	DRILL 38XD3 WCM 06T308	182,33 €
WCM.D3 038,5 ISO	✓	✓	DRILL 38,5XD3 WCM 06T308	182,33 €
WCM.D3 039 ISO	✓	✓	DRILL 39XD3 WCM 06T308	182,33 €
WCM.D3 039,5 ISO	✓	✓	DRILL 39,5XD3 WCM 06T308	182,33 €
WCM.D3 040 ISO	✓	✓	DRILL 40XD3 WCM 06T308	182,33 €
WCM.D3 041 ISO	✓	✓	DRILL 41XD3 WCM 06T308	203,00 €
WCM.D3 042 ISO	✓	✓	DRILL 42XD3 WCM 06T308	203,00 €
WCM.D3 043 ISO	✓	✓	DRILL 43XD3 WCM 06T308	203,00 €
WCM.D3 044 ISO	✓	✓	DRILL 44XD3 WCM 06T308	203,00 €
WCM.D3 045 ISO	✓	✓	DRILL 45XD3 WCM 080412	212,33 €
WCM.D3 046 ISO	✓	✓	DRILL 46XD3 WCM 080412	224,00 €
WCM.D3 047 ISO	✓	✓	DRILL 47XD3 WCM 080412	233,00 €
WCM.D3 048 ISO	✓	✓	DRILL 48XD3 WCM 080412	245,00 €
WCM.D3 049 ISO	✓	✓	DRILL 49XD3 WCM 080412	254,00 €
WCM.D3 050 ISO	✓	✓	DRILL 50XD3 WCM 080412	272,00 €

DRILL WCM. D4

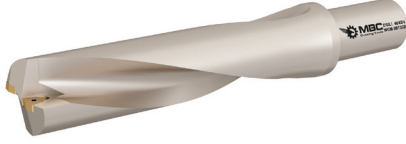

DRILL WCM. D5



Lütfen Sipariş vermeden önce stok durumunu sorunuz.
Please ask before ordering, stock status.

KOD	Stok Stock	Inter Cooland	Kesici Uç Uyumluluğu / Insert Suitability		FİYAT PRICE
			WCM.		EURO
WCM.D4 015,5 ISO	✓	✓	DRILL 15,5XD4 WCM 030208		191,33 €
WCM.D4 016 ISO	✓	✓	DRILL 16XD4 WCM 030208		191,33 €
WCM.D4 017 ISO	✓	✓	DRILL 17XD4 WCM 030208		191,33 €
WCM.D4 017,5 ISO	✓	✓	DRILL 17,5XD4 WCM 030208		191,33 €
WCM.D4 018 ISO	✓	✓	DRILL 18XD4 WCM 030208		191,33 €
WCM.D4 019 ISO	✓	✓	DRILL 19XD4 WCM 030208		191,33 €
WCM.D4 019,5 ISO	✓	✓	DRILL 19,5XD4 WCM.030208		191,33 €
WCM.D4 020 ISO	✓	✓	DRILL 20XD4 WCM 040208		200,33 €
WCM.D4 021 ISO	✓	✓	DRILL 21XD4 WCM 040208		200,33 €
WCM.D4 022 ISO	✓	✓	DRILL 22XD4 WCM 040208		200,33 €
WCM.D4 023 ISO	✓	✓	DRILL 23XD4 WCM 040208		200,33 €
WCM.D4 023,5 ISO	✓	✓	DRILL 23,5XD4 WCM 040208		200,33 €
WCM.D4 024 ISO	✓	✓	DRILL 24XD4 WCM 050308		209,00 €
WCM.D4 025 ISO	✓	✓	DRILL 25XD4 WCM 050308		209,00 €
WCM.D4 025,5 ISO	✓	✓	DRILL 25,5XD4 WCM 050308		209,00 €
WCM.D4 026 ISO	✓	✓	DRILL 26XD4 WCM 050308		209,00 €
WCM.D4 027 ISO	✓	✓	DRILL 27XD4 WCM 050308		209,00 €
WCM.D4 027,5 ISO	✓	✓	DRILL 27,5XD4 WCM 050308		209,00 €
WCM.D4 028 ISO	✓	✓	DRILL 28XD4 WCM 050308		209,00 €
WCM.D4 029 ISO	✓	✓	DRILL 29XD4 WCM 050308		209,00 €
WCM.D4 030 ISO	✓	✓	DRILL 30XD4 WCM 06T308		227,00 €
WCM.D4 031 ISO	✓	✓	DRILL 31XD4 WCM 06T308		227,00 €
WCM.D4 031,5 ISO	✓	✓	DRILL 31,5XD4 WCM 06T308		227,00 €
WCM.D4 032 ISO	✓	✓	DRILL 32XD4 WCM 06T308		227,00 €
WCM.D4 033 ISO	✓	✓	DRILL 33XD4 WCM 06T308		227,00 €
WCM.D4 033,5 ISO	✓	✓	DRILL 33,5XD4 WCM 06T308		227,00 €
WCM.D4 034 ISO	✓	✓	DRILL 34XD4 WCM 06T308		227,00 €
WCM.D4 035 ISO	✓	✓	DRILL 35XD4 WCM 06T308		227,00 €
WCM.D4 036 ISO	✓	✓	DRILL 36XD4 WCM 06T308		227,00 €
WCM.D4 037 ISO	✓	✓	DRILL 37XD4 WCM 06T308		227,00 €
WCM.D4 038 ISO	✓	✓	DRILL 38XD4 WCM 06T308		227,00 €
WCM.D4 038,5 ISO	✓	✓	DRILL 38,5XD4 WCM 06T308		227,00 €
WCM.D4 039 ISO	✓	✓	DRILL 39XD4 WCM 06T308		227,00 €
WCM.D4 040 ISO	✓	✓	DRILL 40XD4 WCM 06T308		227,00 €
WCM.D4 041 ISO	✓	✓	DRILL 41XD4 WCM 06T308		245,00 €
WCM.D4 041,5 ISO	✓	✓	DRILL 41,5XD4 WCM 06T308		245,00 €
WCM.D4 042 ISO	✓	✓	DRILL 42XD4 WCM 06T308		245,00 €
WCM.D4 043 ISO	✓	✓	DRILL 43XD4 WCM 06T308		245,00 €
WCM.D4 044 ISO	✓	✓	DRILL 44XD4 WCM 06T308		245,00 €
WCM.D4 045 ISO	X	✓	DRILL 45XD4 WCM 080412		256,67 €
WCM.D4 046 ISO	X	✓	DRILL 46XD4 WCM 080412		272,00 €
WCM.D4 047 ISO	X	✓	DRILL 47XD4 WCM 080412		289,67 €
WCM.D4 048 ISO	X	✓	DRILL 48XD4 WCM 080412		298,67 €
WCM.D4 049 ISO	X	✓	DRILL 49XD4 WCM 080412		328,33 €
WCM.D4 050 ISO	X	✓	DRILL 50XD4 WCM 080412		343,33 €

KOD	Stok Stock	Inter Cooland	Kesici Uç Uyumluluğu / Insert Suitability		FİYAT PRICE
			WCM.		EURO
WCM.D5 016 ISO	✓	✓	DRILL 16XD5 WCM 030208		242,00 €
WCM.D5 017 ISO	✓	✓	DRILL 17XD5 WCM 030208		242,00 €
WCM.D5 018 ISO	✓	✓	DRILL 18XD5 WCM 030208		242,00 €
WCM.D5 019 ISO	✓	✓	DRILL 19XD5 WCM 030208		254,00 €
WCM.D5 020 ISO	✓	✓	DRILL 20XD5 WCM 040208		254,00 €
WCM.D5 021 ISO	✓	✓	DRILL 21XD5 WCM 040208		254,00 €
WCM.D5 022 ISO	✓	✓	DRILL 22XD5 WCM 040208		254,00 €
WCM.D5 023 ISO	✓	✓	DRILL 23XD5 WCM 040208		275,00 €
WCM.D5 024 ISO	✓	✓	DRILL 24XD5 WCM 050308		275,00 €
WCM.D5 025 ISO	✓	✓	DRILL 25XD5 WCM 050308		275,00 €
WCM.D5 026 ISO	✓	✓	DRILL 26XD5 WCM 050308		275,00 €
WCM.D5 027 ISO	✓	✓	DRILL 27XD5 WCM 050308		275,00 €
WCM.D5 028 ISO	✓	✓	DRILL 28XD5 WCM 050308		275,00 €
WCM.D5 029 ISO	✓	✓	DRILL 29XD5 WCM 050308		275,00 €
WCM.D5 030 ISO	✓	✓	DRILL 30XD5 WCM 06T308		284,00 €

L: Sol / Left

R: Sağ / Right

✓ Stokta / In Stock

X Stokta Yok / Non Stock

DRILL SP.. D2



KOD	Stok Stock	Inter Cooland	Kesici Uç Uyumluluğu / Insert Suitability	FİYAT PRICE
			TGTC / PLBT / ZCC / KLP	EURO
SP..D2 012,5 ISO	✓	✓	DRILL 12,5XD2 SP.050204	145,00 €
SP..D2 013 ISO	✓	✓	DRILL 13XD2 SP.050204	145,00 €
SP..D2 013,5 ISO	✓	✓	DRILL 13,5XD2 SP.050204	145,00 €
SP..D2 014 ISO	✓	✓	DRILL 14XD2 SP.050204	145,00 €
SP..D2 014,5 ISO	✓	✓	DRILL 14,5XD2 SP.060204	145,00 €
SP..D2 015 ISO	✓	✓	DRILL 15XD2 SP.050204	145,00 €
SP..D2 015,5 ISO	✓	✓	DRILL 15,5XD2 SP.060204	145,00 €
SP..D2 016 ISO	✓	✓	DRILL 16XD2 SP.060204	145,00 €
SP..D2 016,5 ISO	✓	✓	DRILL 16,5XD2 SP.060204	145,00 €
SP..D2 017 ISO	✓	✓	DRILL 17XD2 SP.060204	145,00 €
SP..D2 017,5 ISO	✓	✓	DRILL 17,5XD2 SP.060204	145,00 €
SP..D2 018 ISO	✓	✓	DRILL 18XD2 SP.060204	145,00 €
SP..D2 018,5 ISO	✓	✓	DRILL 18,5XD2 SP.060204	145,00 €
SP..D2 019 ISO	✓	✓	DRILL 19XD2 SP.060204	145,00 €
SP..D2 019,5 ISO	✓	✓	DRILL 19,5XD2 SP.060204	145,00 €
SP..D2 020 ISO	✓	✓	DRILL 20XD2 SP.060204	149,33 €
SP..D2 020,5 ISO	✓	✓	DRILL 20,5XD2 SP.060204	149,33 €
SP..D2 021 ISO	✓	✓	DRILL 21XD2 SP.060204	149,33 €
SP..D2 021,5 ISO	✓	✓	DRILL 21,5XD2 SP.060204	149,33 €
SP..D2 022 ISO	✓	✓	DRILL 22XD2 SP.07T308	149,33 €
SP..D2 022,5 ISO	✓	✓	DRILL 22,5XD2 SP.07T308	149,33 €
SP..D2 023 ISO	✓	✓	DRILL 23XD2 SP.07T308	149,33 €
SP..D2 023,5 ISO	✓	✓	DRILL 23,5XD2 SP.07T308	149,33 €
SP..D2 024 ISO	✓	✓	DRILL 24XD2 SP.07T308	149,33 €
SP..D2 024,5 ISO	✓	✓	DRILL 24,5XD2 SP.07T308	149,33 €
SP..D2 025 ISO	✓	✓	DRILL 25XD2 SP.07T308	149,33 €
SP..D2 025,5 ISO	✓	✓	DRILL 25,5XD2 SP.07T308	149,33 €
SP..D2 026 ISO	✓	✓	DRILL 26XD2 SP.07T308	149,33 €
SP..D2 026,5 ISO	✓	✓	DRILL 26,5XD2 SP.07T308	149,33 €
SP..D2 027 ISO	✓	✓	DRILL 27XD2 SP.07T308	149,33 €
SP..D2 027,5 ISO	✓	✓	DRILL 27,5XD2 SP.090408	158,33 €
SP..D2 028 ISO	✓	✓	DRILL 28XD2 SP.090408	158,33 €
SP..D2 028,5 ISO	✓	✓	DRILL 28,5XD2 SP.090408	158,33 €
SP..D2 029 ISO	✓	✓	DRILL 29XD2 SP.090408	158,33 €
SP..D2 029,5 ISO	✓	✓	DRILL 29,5XD2 SP.090408	158,33 €
SP..D2 030 ISO	✓	✓	DRILL 30XD2 SP.090408	158,33 €
SP..D2 031 ISO	✓	✓	DRILL 31XD2 SP.090408	158,33 €
SP..D2 032 ISO	✓	✓	DRILL 32XD2 SP.090408	158,33 €
SP..D2 033 ISO	✓	✓	DRILL 33XD2 SP.090408	179,33 €
SP..D2 034 ISO	✓	✓	DRILL 34XD2 SP.110408	179,33 €
SP..D2 035 ISO	✓	✓	DRILL 35XD2 SP.110408	179,33 €
SP..D2 036 ISO	✓	✓	DRILL 36XD2 SP.110408	179,33 €
SP..D2 037 ISO	✓	✓	DRILL 37XD2 SP.110408	179,33 €
SP..D2 038 ISO	✓	✓	DRILL 38XD2 SP.110408	179,33 €
SP..D2 039 ISO	✓	✓	DRILL 39XD2 SP.110408	179,33 €
SP..D2 040 ISO	✓	✓	DRILL 40XD2 SP.110408	179,33 €
SP..D2 041 ISO	✓	✓	DRILL 41XD2 SP.110408	185,33 €
SP..D2 042 ISO	✓	✓	DRILL 42XD2 SP.140512	185,33 €
SP..D2 42,5 ISO	✓	✓	DRILL 42,5XD2 SP.140512	185,33 €
SP..D2 043 ISO	✓	✓	DRILL 43XD2 SP.140512	185,33 €
SP..D2 044 ISO	✓	✓	DRILL 44XD2 SP.140512	185,33 €
SP..D2 045 ISO	✓	✓	DRILL 45XD2 SP.140512	194,33 €
SP..D2 046 ISO	✓	✓	DRILL 46XD2 SP.140512	209,00 €
SP..D2 047 ISO	✓	✓	DRILL 47XD2 SP.140512	224,00 €
SP..D2 048 ISO	✓	✓	DRILL 48XD2 SP.140512	233,00 €
SP..D2 049 ISO	✓	✓	DRILL 49XD2 SP.140512	242,00 €
SP..D2 050 ISO	✓	✓	DRILL 50XD2 SP.140512	254,00 €

DRILL SP.. D3



KOD	Stok Stock	Inter Cooland	Kesici Uç Uyumluluğu / Insert Suitability		FİYAT PRICE
			TGTC / PLBT / ZCC / KLP		EURO
SP..D3 012,5 ISO	✓	✓	DRILL 12,5XD3 SP.050204		155,33 €
SP..D3 013 ISO	✓	✓	DRILL 13XD3 SP.050204		155,33 €
SP..D3 013,5 ISO	✓	✓	DRILL 13,5XD3 SP.050204		155,33 €
SP..D3 014 ISO	✓	✓	DRILL 14XD3 SP.050204		155,33 €
SP..D3 014,5 ISO	✓	✓	DRILL 14,5XD3 SP.050204		155,33 €
SP..D3 015 ISO	✓	✓	DRILL 15XD3 SP.050204		155,33 €
SP..D3 015,5 ISO	✓	✓	DRILL 15,5XD3 SP.050204		155,33 €
SP..D3 016 ISO	✓	✓	DRILL 16XD3 SP.060204		155,33 €
SP..D3 016,5 ISO	✓	✓	DRILL 16,5XD3 SP.060204		155,33 €
SP..D3 017 ISO	✓	✓	DRILL 17XD3 SP.060204		155,33 €
SP..D3 017,5 ISO	✓	✓	DRILL 17,5XD3 SP.060204		155,33 €
SP..D3 018 ISO	✓	✓	DRILL 18XD3 SP.060204		155,33 €
SP..D3 018,5 ISO	✓	✓	DRILL 18,5XD3 SP.060204		155,33 €
SP..D3 019 ISO	✓	✓	DRILL 19XD3 SP.060204		155,33 €
SP..D3 019,5 ISO	✓	✓	DRILL 19,5XD3 SP.060204		155,33 €
SP..D3 020 ISO	✓	✓	DRILL 20XD3 SP.060204		164,33 €
SP..D3 020,5 ISO	✓	✓	DRILL 20,5XD3 SP.060204		164,33 €
SP..D3 021 ISO	✓	✓	DRILL 21XD3 SP.060204		164,33 €
SP..D3 021,5 ISO	✓	✓	DRILL 21,5XD3 SP.060204		164,33 €
SP..D3 022 ISO	✓	✓	DRILL 22XD3 SP.07T308		164,33 €
SP..D3 022,5 ISO	✓	✓	DRILL 22,5XD3 SP.07T308		164,33 €
SP..D3 023 ISO	✓	✓	DRILL 23XD3 SP.07T308		164,33 €
SP..D3 023,5 ISO	✓	✓	DRILL 23,5XD3 SP.07T308		164,33 €
SP..D3 024 ISO	✓	✓	DRILL 24XD3 SP.07T308		167,33 €
SP..D3 024,5 ISO	✓	✓	DRILL 24,5XD3 SP.07T308		167,33 €
SP..D3 025 ISO	✓	✓	DRILL 25XD3 SP.07T308		167,33 €
SP..D3 025,5 ISO	✓	✓	DRILL 25,5XD3 SP.07T308		167,33 €
SP..D3 026 ISO	✓	✓	DRILL 26XD3 SP.07T308		167,33 €
SP..D3 026,5 ISO	✓	✓	DRILL 26,5XD3 SP.07T308		167,33 €
SP..D3 027 ISO	✓	✓	DRILL 27XD3 SP.07T308		167,33 €
SP..D3 027,5 ISO	✓	✓	DRILL 27,5XD3 SP.07T308		167,33 €
SP..D3 028 ISO	✓	✓	DRILL 28XD3 SP.090408		167,33 €
SP..D3 028,5 ISO	✓	✓	DRILL 28,5XD3 SP.090408		167,33 €
SP..D3 029 ISO	✓	✓	DRILL 29XD3 SP.090408		167,33 €
SP..D3 029,5 ISO	✓	✓	DRILL 29,5XD3 SP.090408		167,33 €
SP..D3 030 ISO	✓	✓	DRILL 30XD3 SP.090408		182,33 €
SP..D3 031 ISO	✓	✓	DRILL 31XD3 SP.090408		182,33 €
SP..D3 032 ISO	✓	✓	DRILL 32XD3 SP.090408		182,33 €
SP..D3 033 ISO	✓	✓	DRILL 33XD3 SP.090408		182,33 €
SP..D3 034 ISO	✓	✓	DRILL 34XD3 SP.110408		182,33 €
SP..D3 035 ISO	✓	✓	DRILL 35XD3 SP.110408		182,33 €
SP..D3 036 ISO	✓	✓	DRILL 36XD3 SP.110408		182,33 €
SP..D3 037 ISO	✓	✓	DRILL 37XD3 SP.110408		182,33 €
SP..D3 038 ISO	✓	✓	DRILL 38XD3 SP.110408		182,33 €
SP..D3 038,5 ISO	✓	✓	DRILL 38,5XD3 SP.110408		182,33 €
SP..D3 039 ISO	✓	✓	DRILL 39XD3 SP.110408		182,33 €
SP..D3 040 ISO	✓	✓	DRILL 40XD3 SP.110408		182,33 €
SP..D3 041 ISO	✓	✓	DRILL 41XD3 SP.110408		203,00 €
SP..D3 041,5 ISO	✓	✓	DRILL 41,5XD3 SP.110408		203,00 €
SP..D3 042 ISO	✓	✓	DRILL 42XD3 SP.140512		203,00 €
SP..D3 043 ISO	✓	✓	DRILL 43XD3 SP.140512		203,00 €
SP..D3 044 ISO	✓	✓	DRILL 44XD3 SP.140512		203,00 €
SP..D3 045 ISO	✓	✓	DRILL 45XD3 SP.140512		212,33 €
SP..D3 046 ISO	✓	✓	DRILL 46XD3 SP.140512		224,00 €
SP..D3 047 ISO	✓	✓	DRILL 47XD3 SP.140512		233,00 €
SP..D3 048 ISO	✓	✓	DRILL 48XD3 SP.140512		245,00 €
SP..D3 049 ISO	✓	✓	DRILL 49XD3 SP.140512		254,00 €
SP..D3 050 ISO	✓	✓	DRILL 50XD3 SP.140512		272,00 €
SP..D3 050,5 ISO	✗	✓	DRILL 50,5XD3 SP.140512		277,67 €

DRILL SP.. D4



KOD	Stok Stock	Infer Cooland	Kesici Uç Uyumluluğu / Insert Suitability	FIYAT PRICE
			TGTC / PLBT / ZCC / KLP	EURO
SP..D4 013 ISO	✓	✓	DRILL 13XD4 SP.050204	191,33 €
SP..D4 014 ISO	✓	✓	DRILL 14XD4 SP.050204	191,33 €
SP..D4 014,5 ISO	✓	✓	DRILL 14,5XD4 SP.050204	191,33 €
SP..D4 015 ISO	✓	✓	DRILL 15XD4 SP.050204	191,33 €
SP..D4 015,5 ISO	✓	✓	DRILL 15,5XD4 SP.050204	191,33 €
SP..D4 016 ISO	✓	✓	DRILL 16XD4 SP.060204	191,33 €
SP..D4 017 ISO	✓	✓	DRILL 17XD4 SP.060204	191,33 €
SP..D4 017,5 ISO	✓	✓	DRILL 17,5XD4 SP.060204	191,33 €
SP..D4 018 ISO	✓	✓	DRILL 18XD4 SP.060204	191,33 €
SP..D4 019 ISO	✓	✓	DRILL 19XD4 SP.060204	191,33 €
SP..D4 019,5 ISO	✓	✓	DRILL 19,5XD4 SP.060204	191,33 €
SP..D4 020 ISO	✓	✓	DRILL 20XD4 SP.060204	200,33 €
SP..D4 021 ISO	✓	✓	DRILL 21XD4 SP.060204	200,33 €
SP..D4 022 ISO	✓	✓	DRILL 22XD4 SP.070204	200,33 €
SP..D4 023 ISO	✓	✓	DRILL 23XD4 SP.070204	200,33 €
SP..D4 023,5 ISO	✓	✓	DRILL 23,5XD4 SP.07T308	200,33 €
SP..D4 024 ISO	✓	✓	DRILL 24XD4 SP.07T308	209,00 €
SP..D4 024,5 ISO	✓	✓	DRILL 24,5XD4 SP.07T308	209,00 €
SP..D4 025 ISO	✓	✓	DRILL 25XD4 SP.07T308	209,00 €
SP..D4 026 ISO	✓	✓	DRILL 26XD4 SP.07T308	209,00 €
SP..D4 027 ISO	✓	✓	DRILL 27XD4 SP.07T308	209,00 €
SP..D4 027,5 ISO	✓	✓	DRILL 27,5XD4 SP.07T308	209,00 €
SP..D4 028 ISO	✓	✓	DRILL 28XD4 SP.090408	209,00 €
SP..D4 029 ISO	✓	✓	DRILL 29XD4 SP.090408	209,00 €
SP..D4 030 ISO	✓	✓	DRILL 30XD4 SP.090408	227,00 €
SP..D4 031 ISO	✓	✓	DRILL 31XD4 SP.090408	227,00 €
SP..D4 032 ISO	✓	✓	DRILL 32XD4 SP.090408	227,00 €
SP..D4 033 ISO	✓	✓	DRILL 33XD4 SP.090408	227,00 €
SP..D4 033,5 ISO	✓	✓	DRILL 33,5XD4 SP.090408	227,00 €
SP..D4 034 ISO	✓	✓	DRILL 34XD4 SP.110408	227,00 €
SP..D4 035 ISO	✓	✓	DRILL 35XD4 SP.110408	227,00 €
SP..D4 036 ISO	✓	✓	DRILL 36XD4 SP.110408	227,00 €
SP..D4 037 ISO	✓	✓	DRILL 37XD4 SP.110408	227,00 €
SP..D4 038 ISO	✓	✓	DRILL 38XD4 SP.110408	227,00 €
SP..D4 038,5 ISO	✓	✓	DRILL 38,5XD4 SP.110408	227,00 €
SP..D4 039 ISO	✓	✓	DRILL 39XD4 SP.110408	227,00 €
SP..D4 039,5 ISO	✓	✓	DRILL 39,5XD4 SP.110408	227,00 €
SP..D4 040 ISO	✓	✓	DRILL 40XD4 SP.110408	227,00 €
SP..D4 041 ISO	✓	✓	DRILL 41XD4 SP.110408	245,00 €
SP..D4 042 ISO	x	✓	DRILL 42XD4 SP.140512	245,00 €
SP..D4 043 ISO	x	✓	DRILL 43XD4 SP.140512	245,00 €
SP..D4 044 ISO	x	✓	DRILL 44XD4 SP.140512	245,00 €
SP..D4 045 ISO	x	✓	DRILL 45XD4 SP.140512	245,00 €
SP..D4 046 ISO	x	✓	DRILL 46XD4 SP.140512	256,67 €
SP..D4 047 ISO	x	✓	DRILL 47XD4 SP.140512	272,00 €
SP..D4 048 ISO	x	✓	DRILL 48XD4 SP.140512	289,67 €
SP..D4 049 ISO	x	✓	DRILL 49XD4 SP.140512	298,67 €
SP..D4 050 ISO	x	✓	DRILL 50XD4 SP.140512	328,33 €

DRILL SP.. D5



KOD	Stok Stock	Inter Cooland	Kesici Uç Uyumluluğu / Insert Suitability	FİYAT PRICE
			TGTC / PLBT / ZCC / KLP	EURO
SP..D5 016 ISO	✓	✓	DRILL 16XD5 SP.060204	233,00 €
SP..D5 017 ISO	✓	✓	DRILL 17XD5 SP.060204	233,00 €
SP..D5 018 ISO	✓	✓	DRILL 18XD5 SP.060204	233,00 €
SP..D5 019 ISO	✓	✓	DRILL 19XD5 SP.060204	233,00 €
SP..D5 020 ISO	✓	✓	DRILL 20XD5 SP.060204	245,00 €
SP..D5 021 ISO	✓	✓	DRILL 21XD5 SP.060204	245,00 €
SP..D5 022 ISO	✓	✓	DRILL 22XD5 SP.070204	245,00 €
SP..D5 023 ISO	✓	✓	DRILL 23XD5 SP.070204	256,67 €
SP..D5 024 ISO	✓	✓	DRILL 24XD5 SP.07T308	256,67 €
SP..D5 025 ISO	✓	✓	DRILL 25XD5 SP.07T308	256,67 €
SP..D5 026 ISO	✓	✓	DRILL 26XD5 SP.07T308	256,67 €
SP..D5 027 ISO	✓	✓	DRILL 27XD5 SP.07T308	256,67 €
SP..D5 028 ISO	✓	✓	DRILL 28XD5 SP.090408	268,67 €
SP..D5 029 ISO	✓	✓	DRILL 29XD5 SP.090408	268,67 €
SP..D5 030 ISO	✓	✓	DRILL 30XD5 SP.090408	268,67 €

DRILL XOMT-SPMT D2



KOD	Stok Stock	Inter Cooland	Kesici Uç Uyumluluğu / Insert Suitability	FİYAT PRICE
			XO*T-SP*T	EURO
XOSP D2 016 ISO	✓	✓	DRILL 16XD2 SPMT 050204-XOMT 050204	146,33 €
XOSP D2 017 ISO	✓	✓	DRILL 17XD2 SPMT 060205-XOMT 060204	146,33 €
XOSP D2 018 ISO	✓	✓	DRILL 18XD2 SPMT 060205-XOMT 060204	146,33 €
XOSP D2 019 ISO	✓	✓	DRILL 19XD2 SPMT 060205-XOMT 060204	146,33 €
XOSP D2 020 ISO	✓	✓	DRILL 20XD2 SPMT 07T208-XOMT 07T205	152,33 €
XOSP D2 021 ISO	✓	✓	DRILL 21XD2 SPMT 07T208-XOMT 07T205	152,33 €
XOSP D2 022 ISO	✓	✓	DRILL 22XD2 SPMT 07T208-XOMT 07T205	152,33 €
XOSP D2 023 ISO	✓	✓	DRILL 23XD2 SPMT 07T208-XOMT 07T205	152,33 €
XOSP D2 024 ISO	✓	✓	DRILL 24XD2 SPMT 090308-XOMT 090305	158,33 €
XOSP D2 025 ISO	✓	✓	DRILL 25XD2 SPMT 090308-XOMT 090305	158,33 €
XOSP D2 026 ISO	✓	✓	DRILL 26XD2 SPMT 090308-XOMT 090305	158,33 €
XOSP D2 027 ISO	✓	✓	DRILL 27XD2 SPMT 090308-XOMT 090305	158,33 €
XOSP D2 028 ISO	✓	✓	DRILL 28XD2 SPMT 090308-XOMT 090305	158,33 €
XOSP D2 029 ISO	✓	✓	DRILL 29XD2 SPMT 090308-XOMT 090305	158,33 €
XOSP D2 030 ISO	✓	✓	DRILL 30XD2 SPMT 11T308-XOMT 11T306	176,33 €
XOSP D2 031 ISO	✓	✓	DRILL 31XD2 SPMT 11T308-XOMT 11T306	176,33 €
XOSP D2 032 ISO	✓	✓	DRILL 32XD2 SPMT 11T308-XOMT 11T306	176,33 €
XOSP D2 033 ISO	✓	✓	DRILL 33XD2 SPMT 11T308-XOMT 11T306	176,33 €
XOSP D2 034 ISO	✓	✓	DRILL 34XD2 SPMT 11T308-XOMT 11T306	176,33 €
XOSP D2 035 ISO	✓	✓	DRILL 35XD2 SPMT 11T308-XOMT11T306	176,33 €

DRILL XOMT-SPMT D3



DRILL XOMT-SPMT D4



ECOCUT

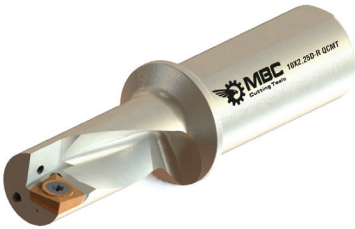

KOD	Stok Stock	Inter Cooland	Kesici Uç Uyumluluğu / Insert Suitability		FIYAT PRICE
			XO*T-SP*T		EURO
XOSP D3 016 ISO	✓	✓	DRILL 16XD3 SPMT 050204-XOMT 050204		164,33 €
XOSP D3 017 ISO	✓	✓	DRILL 17XD3 SPMT 060205-XOMT 060204		164,33 €
XOSP D3 018 ISO	✓	✓	DRILL 18XD3 SPMT 060205-XOMT 060204		164,33 €
XOSP D3 019 ISO	✓	✓	DRILL 19XD3 SPMT 060205-XOMT 060204		164,33 €
XOSP D3 020 ISO	✓	✓	DRILL 20XD3 SPMT 07T208-XOMT 07T205		170,67 €
XOSP D3 021 ISO	✓	✓	DRILL 21XD3 SPMT 07T208-XOMT 07T205		170,67 €
XOSP D3 022 ISO	✓	✓	DRILL 22XD3 SPMT 07T208-XOMT 07T205		170,67 €
XOSP D3 023 ISO	✓	✓	DRILL 23XD3 SPMT 07T208-XOMT 07T205		170,67 €
XOSP D3 024 ISO	✓	✓	DRILL 24XD3 SPMT 090308-XOMT 090305		170,67 €
XOSP D3 025 ISO	✓	✓	DRILL 25XD3 SPMT 090308-XOMT 090305		176,33 €
XOSP D3 026 ISO	✓	✓	DRILL 26XD3 SPMT 090308-XOMT 090305		176,33 €
XOSP D3 027 ISO	✓	✓	DRILL 27XD3 SPMT 090308-XOMT 090305		176,33 €
XOSP D3 028 ISO	✓	✓	DRILL 28XD3 SPMT 090308-XOMT 090305		176,33 €
XOSP D3 029 ISO	✓	✓	DRILL 29XD3 SPMT 090308-XOMT 090305		176,33 €
XOSP D3 030 ISO	✓	✓	DRILL 30XD3 SPMT 11T308-XOMT 11T306		194,33 €
XOSP D3 031 ISO	✓	✓	DRILL 31XD3 SPMT 11T308-XOMT 11T306		194,33 €
XOSP D3 032 ISO	✓	✓	DRILL 32XD3 SPMT 11T308-XOMT 11T306		194,33 €
XOSP D3 033 ISO	✓	✓	DRILL 33XD3 SPMT 11T308-XOMT 11T306		194,33 €
XOSP D3 034 ISO	✓	✓	DRILL 34XD3 SPMT 11T308-XOMT 11T306		194,33 €
XOSP D3 035 ISO	✓	✓	DRILL 35XD3 SPMT 11T308-XOMT 11T306		194,33 €

KOD	Stok Stock	Inter Cooland	Kesici Uç Uyumluluğu / Insert Suitability		FIYAT PRICE
			XO*T-SP*T		EURO
XOSP D4 016 ISO	✓	✓	DRILL 16XD4 SPMT 050204-XOMT 050204		215,00 €
XOSP D4 017 ISO	✓	✓	DRILL 17XD4 SPMT 060205-XOMT 060204		215,00 €
XOSP D4 018 ISO	✓	✓	DRILL 18XD4 SPMT 060205-XOMT 060204		215,00 €
XOSP D4 019 ISO	✓	✓	DRILL 19XD4 SPMT 060205-XOMT 060204		215,00 €
XOSP D4 020 ISO	✓	✓	DRILL 20XD4 SPMT 07T208-XOMT 07T205		215,00 €
XOSP D4 021 ISO	✓	✓	DRILL 21XD4 SPMT 07T208-XOMT 07T205		221,33 €
XOSP D4 022 ISO	✓	✓	DRILL 22XD4 SPMT 07T208-XOMT 07T205		221,33 €
XOSP D4 023 ISO	✓	✓	DRILL 23XD4 SPMT 07T208-XOMT 07T205		221,33 €
XOSP D4 024 ISO	✓	✓	DRILL 24XD4 SPMT 090308-XOMT 090305		221,33 €
XOSP D4 025 ISO	✓	✓	DRILL 25XD4 SPMT 090308-XOMT 090305		221,33 €
XOSP D4 026 ISO	✓	✓	DRILL 26XD4 SPMT 090308-XOMT 090305		242,00 €
XOSP D4 027 ISO	✓	✓	DRILL 27XD4 SPMT 090308-XOMT 090305		242,00 €
XOSP D4 028 ISO	✓	✓	DRILL 28XD4 SPMT 090308-XOMT 090305		242,00 €
XOSP D4 029 ISO	✓	✓	DRILL 29XD4 SPMT 090308-XOMT 090305		242,00 €
XOSP D4 030 ISO	✓	✓	DRILL 30XD4 SPMT 11T308-XOMT 11T306		254,00 €
XOSP D4 031 ISO	✓	✓	DRILL 31XD4 SPMT 11T308-XOMT 11T306		254,00 €
XOSP D4 032 ISO	✓	✓	DRILL 32XD4 SPMT 11T308-XOMT 11T306		254,00 €
XOSP D4 033 ISO	✓	✓	DRILL 33XD4 SPMT 11T308-XOMT 11T306		254,00 €
XOSP D4 034 ISO	✓	✓	DRILL 34XD4 SPMT 11T308-XOMT 11T306		254,00 €
XOSP D4 035 ISO	✓	✓	DRILL 35XD4 SPMT 11T308-XOMT 11T306		254,00 €

KOD	Stok Stock	Inter Cooland	Kesici Uç Uyumluluğu / Insert Suitability		FIYAT PRICE
			QCMT - KRLY		EURO
MBC 002 ECOCUT KRLY	✓	✓	MBC 10X2,25D-R QCMT 050204		116,00 €
MBC 003 ECOCUT KRLY	✓	✓	MBC 12X2,25D-R QCMT 060204		120,00 €
MBC 004 ECOCUT KRLY	✓	✓	MBC 14X2,25D-R QCMT 070304		125,00 €
MBC 005 ECOCUT KRLY	✓	✓	MBC 16X2,25D-R QCMT 080304		132,00 €
MBC 007 ECOCUT KRLY	✓	✓	MBC 20X2,25D-R QCMT 10T304		146,00 €
MBC 008 ECOCUT KRLY	✓	✓	MBC 25X2,25D-R QCMT 130404		160,00 €

PASO KATERLERİ
STEP CUTTING TOOLS

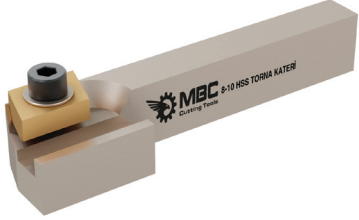

KOD	Stok / Stock	Kesici Uç Uyumluluğu / Insert Suitability	FİYAT PRICE
		TORNA KATERİ	EURO
HSS PS 001 ISO	✓	6 / 8 HSS TORNA KATERİ	55,67 €
HSS PS 002 ISO	✓	8 / 10 HSS TORNA KATERİ	55,67 €
HSS PS 003 ISO	✓	10 / 12 HSS TORNA KATERİ	55,67 €
HSS PS 004 ISO	✓	12 / 14 HSS TORNA KATERİ	55,67 €

KESME KATERLERİ
CUTTING TOOLS

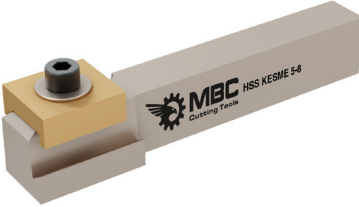

KOD	Stok / Stock	Kesici Uç Uyumluluğu / Insert Suitability	FİYAT PRICE
		TORNA KATERİ	EURO
HSS KS 001 ISO	✓	HSS KESME 1/2	55,67 €
HSS KS 002 ISO	✓	HSS KESME 5/8	55,67 €
HSS KS 003 ISO	✓	HSS KESME 3/4	55,67 €
HSS KS 004 ISO	✓	HSS KESME 7/8	61,67 €
HSS KS 005 ISO	✓	HSS KESME 1"	61,67 €

PUNTA KATERİ
PUNTA TOOL



KOD	Stok / Stock	Kesici Uç Uyumluluğu / Insert Suitability	FİYAT PRICE
		TORNA KATERİ	EURO
CNC PUNTA 001	✓	20X20 CNC PUNTA 2,5X6,3	75,67 €
CNC PUNTA 002	✓	20X20 CNC PUNTA 3,15X8	75,67 €
CNC PUNTA 004	✓	25X25 CNC PUNTA 2,5X6,3	81,00 €
CNC PUNTA 005	✓	25X25 CNC PUNTA 3,15X8	81,00 €

TIRTIR TEKLİ
SINGLE TOOLS



KOD	Stok / Stock	Kesici Uç Uyumluluğu / Insert Suitability		FIYAT PRICE
		TIRTIR KATER		EURO
TIR-TIR 001	x	TIRTIR 10X10 4K-4P		55,67 €
TIR-TIR 003	x	TIRTIR 12X12 6K-4P		55,67 €
TIR-TIR 004	x	TIRTIR 12X12 6K-6P		55,67 €
TIR-TIR 007	✓	TIRTIR 20X20 8K		65,00 €
TIR-TIR 008	✓	TIRTIR 20X20 10K		65,00 €
TIR-TIR 009	✓	TIRTIR 25X25 8K		74,33 €
TIR-TIR 010	✓	TIRTIR 25X25 10K		74,33 €
TIR-TIR 015	✓	TIRTIR 16X16 6K-4P		55,67 €
TIR-TIR 016	✓	TIRTIR 16X16 6K-6P		55,67 €
TIR-TIR 017	✓	TIRTIR 16X16 8K-6P		55,67 €
TIR-TIR 018	✓	TIRTIR 16X16 10K-6P		55,67 €
TIR-TIR 019	✓	CNC TIRTIR 25X25 10K		71,00 €
TIR-TIR 020	✓	CNC TIRTIR 20X20 10K		61,67 €
TIR-TIR 021	✓	CNC TIRTIR 16X16 8K R45		55,67 €

TIRTIR ÇİFTLİ
DOUBLE TOOLS



KOD	Stok / Stock	Kesici Uç Uyumluluğu / Insert Suitability		FIYAT PRICE
		ÇİFTLİ TIRTIR		EURO
TIR TIR Ç 001	✓	ÇİFTLİ TIRTIR 22X22 10K		80,34 €

T SOMUN

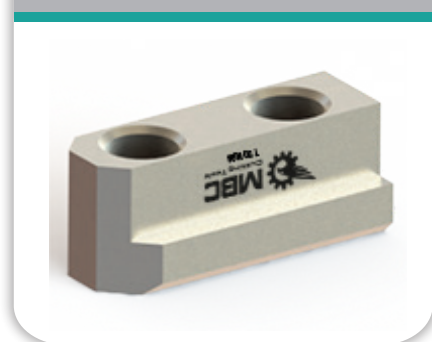

KOD	Stok / Stock	Kesici Uç Uyumluluğu / Insert Suitability		FIYAT PRICE
		T SOMUN		EURO
TS6 001 6" T-SOMUN	✓	TS6 001 6" T-SOMUN		72,00 €
TS6 002 8" T-SOMUN	✓	TS6 002 8" T-SOMUN		98,33 €
TS6 003 10" T-SOMUN	✓	TS6 003 10" T-SOMUN		107,33 €
TS6 004 12" T-SOMUN	✓	TS6 004 12" T-SOMUN		132,33 €

STANDART YUMUŞAK AYAK
STANDARD SOFT JAWS

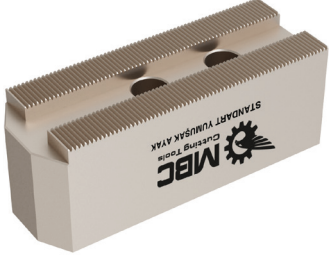

KOD	Stok / Stock	Kesici Uç Uyumluluğu / Insert Suitability	FIYAT PRICE
		SYA	EURO
SYA 001	✓	8" STANDART YUMUŞAK AYAK	68,00 €
SYA 002	✓	10" STANDART YUMUŞAK AYAK	77,33 €
SYA 003	✓	6" STANDART YUMUŞAK AYAK	60,33 €
SYA 004	✓	12" STANDART YUMUŞAK AYAK	103,33 €

SİVRİ STANDART YUMUŞAK AYAK
POINTED STANDARD SOFT JAWS

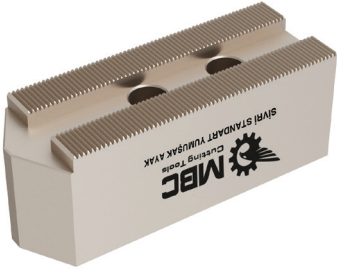

KOD	Stok / Stock	Kesici Uç Uyumluluğu / Insert Suitability	FIYAT PRICE
		SSYA	EURO
SSYA 001	✓	8" SİVRİ STANDART YUMUŞAK AYAK	68,00 €
SSYA 002	✓	10" SİVRİ STANDART YUMUŞAK AYAK	77,33 €

YÜKSEK YUMUŞAK AYAK
HIGH SOFT JAWS





KOD	Stok / Stock	Kesici Uç Uyumluluğu / Insert Suitability	FIYAT PRICE
		YYA	EURO
YYA 001	✓	8" YÜKSEK YUMUŞAK AYAK	123,33 €
YYA 002	✓	10" YÜKSEK YUMUŞAK AYAK	91,33 €
YYA 003	✓	6" YÜKSEK YUMUŞAK AYAK	108,33 €
YYA 004	✓	12" YÜKSEK YUMUŞAK AYAK	172,33 €

ÇİVATALAR - SCREWS

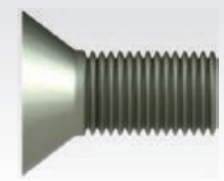
BASKI ÇİVATALARI		FIYAT PRICE EURO
	M5X23 A3	2,67 €
	M6X27 A3	2,67 €

ALTLIK VİDALARI		FIYAT PRICE EURO
	M3X10	1,67 €
	M4X10	1,67 €
	M5X10	1,67 €
	M6X10	1,67 €

BUKSE VİDA		FIYAT PRICE EURO
	M5X0.5X3.5	3,33 €
	M6X0.75X4	3,94 €

TORX VİDALARI		FIYAT PRICE EURO
	M1.8X4.2X2.4	4,68 €
	M2X4	1,67 €
	M2X5	1,67 €
	M2.2X5	1,67 €
	M2.2X6	1,67 €
	M2.5X5	1,67 €
	M2.5X6	1,67 €
	M2.5X7	1,67 €
	M2.5X10	1,67 €
	M3X7	1,67 €
	M3X8	1,67 €
	M3X8X4.20	1,67 €
	M3X9	1,67 €
	M3X10	1,67 €

BASKI VİDASI		FIYAT PRICE EURO
	M6X0.75 TPKN 16	2,60 €

BASKI VİDASI		FIYAT PRICE EURO
	M8X1 TPKN 22	3,36 €

TORX VİDALARI		FIYAT PRICE EURO
	M3.5X8X4.8	€ 1,67
	M3.5X8X5.3	€ 1,67
	M3.5X10X5.30	€ 1,67
	M3.5X11X4.80	€ 1,67
	M3.5X12X5.30	€ 1,67
	M3.5X14X5.30	€ 1,67
	M3.5X14X4,80	€ 1,67
	M4X9	€ 1,67
	M4X10X5,8	€ 1,67
	M4X11	€ 1,67
	M4X14	€ 1,67
	M4X16	€ 1,67
	M4X16X7 WALTER	€ 1,67
	M4.5X12	€ 1,67
	M4.5X17	€ 1,67
	M5X12	€ 1,67
	M5X15	€ 1,67
	M5X17	€ 1,67
	M6X16	€ 1,67

KESME KATER VİDASI		FIYAT PRICE EURO
	M8X27 A4	3,36 €

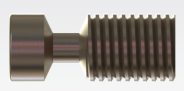
P SİSTEM VİDASI		FIYAT PRICE EURO
	MPV M8 U	5,00 €
	MPV M8 K	5,00 €

KÜRE TAKIM VİDALARI - BALL NOSE SCREWS

KÜRE TAKIM VİDALARI		FIYAT PRICE EURO
	M3X7 D8	4,67 €
	M4X9 D10	4,67 €
	M5X10 D12	4,67 €
	M5X12 D16	4,67 €
	M5X16 D20	4,67 €
	M6X22 D25	4,67 €
	M8X25 D30	4,67 €

ALTLIKLAR - SHIMS

ALTLIK		FIYAT PRICE EURO
	DNMG 15 - T SİSTEM	7,70 €
	DNMG 11 - T SİSTEM	7,00 €
	DNMG 11 - P SİSTEM	7,00 €
	DNMG 15 - P SİSTEM	7,70 €

ALTLIK		FIYAT PRICE EURO
	CNMG 12 - T SİSTEM	8,05 €
	CNMG 16 - T SİSTEM	9,45 €
	CNMG 19 - T SİSTEM	11,20 €
	CNMG 12 - P SİSTEM	8,05 €
	CNMG 16 - P SİSTEM	9,45 €
	CNMG 19 - P SİSTEM	11,20 €

ALTLIK		FIYAT PRICE EURO
	TNMG 16 - TM SİSTEM	7,35 €
	TNMG 22 - TM SİSTEM	8,75 €
	TNMG 16 - P SİSTEM	7,35 €
	TNMG 22 - P SİSTEM	8,75 €

ALTLIK		FIYAT PRICE EURO
	WNMG 06 M SİSTEM	€8,05 €
	WNMG 08 M SİSTEM	€8,05 €
	WNMG 08 T SİSTEM	€8,05 €
	WNMG 08 P SİSTEM	€8,05 €

ALTLIK		FIYAT PRICE EURO
	DCMT 11 S SİSTEM	7,00 €

ALTLIK		FIYAT PRICE EURO
	VBMT 16 - S SİSTEM	€8,05 €
	VNMG 16 T SİSTEM	€8,05 €
	VCMT 16 S SİSTEM	€8,05 €

ALTLIK		FIYAT PRICE EURO
	KNUX 16 SAĞ C SİSTEM	9,45 €

ALTLIK		FIYAT PRICE EURO
	KNUX 16 SOL C SİSTEM	9,45 €

ALTLIK		FIYAT PRICE EURO
	SER 22 - S SİSTEM	€9,80 €
	SIR 22 - S SİSTEM	€9,80 €
	IR-ER 16 ALTLIK SER SEL/SIR SIL	€7,00 €

ALTLIK		FIYAT PRICE EURO
	SNMG 12 - T SİSTEM	8,05 €
	SNMG 15 - T SİSTEM	9,45 €
	SNMG 19 - T SİSTEM	11,20 €
	SNMG 12 - P SİSTEM	8,05 €
	SNMG 15 - P SİSTEM	9,45 €
	SNMG 19 - P SİSTEM	11,20 €

ALTLIK		FIYAT PRICE EURO
	CCMT 12 - S SİSTEM	7,00 €

ALTLIK		FIYAT PRICE EURO
	TCMT 16 - S SİSTEM	7,35 €

P SİSTEM LEVYE			FIYAT PRICE EURO
	MPL 011	DNMG 11-TNMG 16-WNMG 06	7,00 €
	MPL 012	CNMG 12-DNMG15-TNMG 22-WNMG 08	7,00 €
	MPL 016	CNMG 16 - SNMG 15	7,00 €
	MPL 019	CNMG 19 - SNMG 19	7,00 €

P SİSTEM ALTLIK SACI			FIYAT PRICE EURO
	MPS 011	DNMG 11 TNMG 16 WNMG 06	2,33 €
	MPS 012	CNMG 12 DNMG 15 TNMG 22 WNMG 08	2,33 €
	MPS 016	CNMG 16 SNMG 15	2,33 €
	MPS 019	CNMG 19 SNMG 19	2,33 €

BASKI KEPLERİ - CLAMPS

BASKI PABUCU		FIYAT PRICE EURO
	T190105 CNMG 19	9,45 €
	T190105 SNMG 19	9,45 €

BASKI PABUCU		FIYAT PRICE EURO
	M160105 TNMG 16 M	7,00 €
	M220105 TNMG 22 M	7,00 €

BASKI PABUCU		FIYAT PRICE EURO
	T110105 DNMG 11 T SİSTEM	7,33 €
	T160105 TNMG 16 T SİSTEM	7,33 €
	T060105 WNMG 06 T SİSTEM	7,00 €

BASKI PABUCU		FIYAT PRICE EURO
	C110105 SN..12 T	7,00 €
	T120105 CNMG 12 T	7,00 €
	T150105 DNMG 15 T	7,00 €
	T150105 SNMG 15 T	8,40 €
	T220105 TNMG 22 T	7,00 €
	T080105 WNMG08 T	7,00 €

BASKI PABUCU		FIYAT PRICE EURO
	T160105 CNMG 16	8,40 €
	T160105 VNMG 16	8,40 €
	T160105 SNMG 15	8,40 €

BASKI PABUCU		FIYAT PRICE EURO
	M060105 WNMG 06 M SİSTEM	7,00 €

BASKI PABUCU		FIYAT PRICE EURO
	C160105 KNUX 16 SAĞ	7,00 €
	C160105 KNUX 16 SOL	7,00 €
	C160105 KNUX 16 SOL VE SAĞ	4,00 €

BASKI PABUCU		FIYAT PRICE EURO
	CK 14	7,00 €
	CK 15	7,00 €

BASKI PABUCU		FIYAT PRICE EURO
	C160105 TPKN 16	7,00 €

BASKI PABUCU		FIYAT PRICE EURO
	M080105 WNMG 08	7,00 €

M SİSTEM ALTLIK PİMİ		FIYAT PRICE EURO
	6X5X18 TNMG 22	2,33 €
	6X5X18 WNMG 08	2,33 €
	5x3.6x15 TNMG 16	2,33 €

BASKI PABUÇ YAYI		FIYAT PRICE EURO
	BASKI PABUÇU YAYI	0,44 €

BASKI PABUÇ VİDASI PULU		FIYAT PRICE EURO
	10X6X1 MM	0,70 €

TORNALAMA İÇİN FORMÜLLER

DEVİR SAYISI = $n = \frac{V_c \times 1000}{\pi \times D}$ devir / dakika Revolutions / Umdrehungen $\frac{\text{Revs}}{\text{min.}}$ / Umdrehungen / min.	n: Devir Sayısı (dev./dak) Revolutions / Umdrehungen $\frac{\text{Revs}}{\text{min.}}$ / Umdrehungen / min.
KESME HIZI = $V_c = \frac{\pi \times D \times n}{1000}$ metre / dakika Cutting speed / Schnittgeschwindigkeit $\frac{\text{meter}}{\text{min.}}$	Vc: Kesme Hızı (m./dak.) Cutting Speed / Schnittgeschwindigkeit $\frac{\text{Meter}}{\text{Min}}$
	D: İş Parçasının Çapı (mm) Workpiece diameter / Werkstückdurchmesser
	π: Sabit Sayı(3,14) Constant (3,14) / Gleich bleibend (3,14)

TORNALAMA İŞLEMİNDE ZAMANININ HESAPLANMASI

Çap Tornalamada = $th = \frac{L \times Ps}{n \times f}$ dakika Turning diameter / Drehdurchmesser $\frac{\text{min.}}$	Ps: Paso Sayısı (kaç defada) no of passes / Durchgänge
	th: İşleme Zamanı (dakika) Processing Time / Bearbeitungszeit (min)
	f: İlerleme (mm) Length delivery / Stirn Zustellung (min.)
Alın Tornalama = $th = \frac{d \times \pi \times L \times Ps}{V_c \times 1000 \times f}$ dakika Length turning / Stirn Drehen $\frac{\text{min.}}$	Alın Tornalama için Boy Lenght for face turning / Länge für Stirn Drehen $L = \frac{d1 - d2}{2}$ mm
	Dolu Malzemede Alın Tornalama Face turning for solid tool / Massive Werkstücke Stirn Drehen $L = \frac{d}{2}$ mm

YÜZEY FREZELEMEDE KULLANILAN FORMÜLLER

DEVİR SAYISI = $n = \frac{V_c \times 1000}{\pi \times D}$ devir / dakika Revolutions / Umdrehungen $\frac{\text{Revs}}{\text{min.}}$ / Umdrehungen / min.	z: Frezenin Ağız Sayısı (adet) Number of tooth / Anzahl Schneiden
KESME HIZI = $V_c = \frac{\pi \times D \times n}{1000}$ metre / dakika Revolutions / Umdrehungen $\frac{\text{meter}}{\text{min.}}$	k: Disk Frezenin Efektif Ağız sayısı (adet) Effective edge of the cutter / Effektive Schneiden des Fräasers
TABLA İLERLEMESİ = $V_f = n \times z \times f_z$ mm/dak Delivery / Zustellung $\frac{\text{mm}}{\text{min.}}$	fz : Ağız başına ilerleme (mm/ağız) Delivery per cutting mm /Z/ Zustellung pro Schneide mm/Z
	th: İşleme Zamanı (dak.) Processing time / Bearbeitungszeit minute
	Ps : Paso Sayısı Number of passes / Anzahl der Durchgänge

PLASMA NITRATION

Nedir?

Vasıflı çelik malzemelerde uygulanabilen bir yüzey sertleştirme yöntemidir. İşlem için özel tasarlanmış vakum fırınlarında, elektrik akımı vasıtasıyla proses gazlarının iyonize edilerek iş parçalarına yönlendirilmesi sayesinde gerçekleşir.

What Is It?

It is surface hardening method which can be applied inskilled steel materials. The procedure takes place inspecial designed vacuum furnaces by means of electric current in ionizing the process gases and directing them to workpieces.

Avantajlar

- Aşınma direncini artırır.
- Yorulma ömrünü uzatır.
- Çarpılma riski minimum düzeydedir.
- Yüksek yüzey sertliği sağlar.
- Ölçü hassasiyeti yüksektir.
- Korozyon direncini artırır.
- Temiz ve parlak yüzeyler elde edilir.
- Sertlik dağılımı homojendir.
- Çevreyi kirletmez.
- Çalışan sağlığına zarar vermez.

Advantages

- Increases wear resistance.
- Extends fatigue life.
- The risk of distortion is minimal.
- Provides high surface hardness.
- Measurement accuracy is high.
- Increases corrosion resistance.
- Clean and shiny surfaces are obtained.
- Hardness distribution is homogeneous.
- Does not pollute the environment.
- Does not harm employee health.

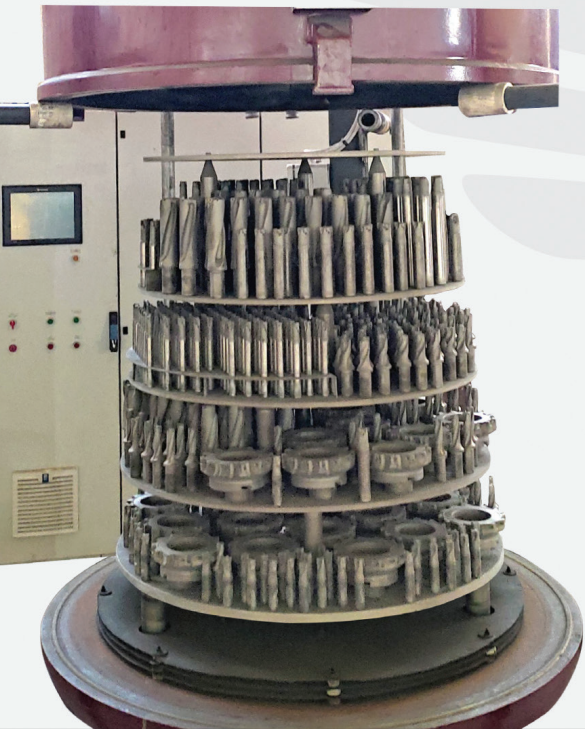
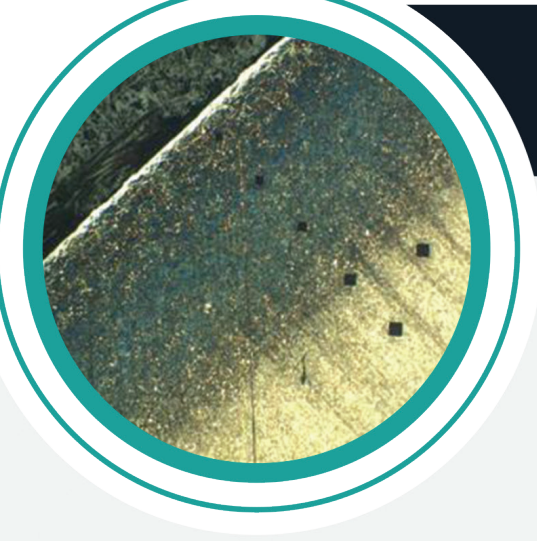



Organize Sanayi Bölgesi 40. Sok. No:19 BURDUR



T. +90 248 252 81 15 - 252 81 65 F. +90 248 252 99 37



info@baydarlar.com - info@mbckesicitakim.com



www.baydarlar.com